



## Medium Voltage Thyristor Types K2085TE600 & K2085TE650

### Absolute Maximum Ratings

	VOLTAGE RATINGS	MAXIMUM LIMITS	UNITS
V <sub>DRM</sub>	Repetitive peak off-state voltage, (note 1)	6000-6500	V
V <sub>DSM</sub>	Non-repetitive peak off-state voltage, (note 1)	6000-6500	V
V <sub>RRM</sub>	Repetitive peak reverse voltage, (note 1)	6000-6500	V
V <sub>RSM</sub>	Non-repetitive peak reverse voltage, (note 1)	6100-6600	V

	OTHER RATINGS	MAXIMUM LIMITS	UNITS
I <sub>T(AV)</sub>	Mean on-state current. T <sub>sink</sub> =55°C, (note 2)	2145	A
I <sub>T(AV)</sub>	Mean on-state current. T <sub>sink</sub> =85°C, (note 2)	1510	A
I <sub>T(AV)</sub>	Mean on-state current. T <sub>sink</sub> =85°C, (note 3)	805	A
I <sub>T(RMS)</sub>	Nominal RMS on-state current. T <sub>sink</sub> =25°C, (note 2)	4180	A
I <sub>T(d.c.)</sub>	D.C. on-state current. T <sub>sink</sub> =25°C, (note 4)	3760	A
I <sub>TSM</sub>	Peak non-repetitive surge t <sub>p</sub> =10ms, V <sub>RM</sub> =0.6V <sub>RRM</sub> , (note 5)	33.0	kA
I <sub>TSM2</sub>	Peak non-repetitive surge t <sub>p</sub> =10ms, V <sub>RM</sub> ≤10V, (note 5)	36.3	kA
I <sup>2</sup> t	I <sup>2</sup> t capacity for fusing t <sub>p</sub> =10ms, V <sub>RM</sub> =0.6V <sub>RRM</sub> , (note 5)	5.45×10 <sup>6</sup>	A <sup>2</sup> s
I <sup>2</sup> t	I <sup>2</sup> t capacity for fusing t <sub>p</sub> =10ms, V <sub>RM</sub> ≤10V, (note 5)	6.59×10 <sup>6</sup>	A <sup>2</sup> s
di <sub>T</sub> /dt	Maximum rate of rise of on-state current (repetitive), (Note 6)	200	A/μs
	Maximum rate of rise of on-state current (non-repetitive), (Note 6)	1000	A/μs
V <sub>RGM</sub>	Peak reverse gate voltage	5	V
P <sub>G(AV)</sub>	Mean forward gate power	5	W
P <sub>GM</sub>	Peak forward gate power	40	W
V <sub>GD</sub>	Non-trigger gate voltage, (Note 7)	0.25	V
T <sub>j op</sub>	Operating temperature range	-40 to +125	°C
T <sub>stg</sub>	Storage temperature range	-40 to +150	°C

#### Notes: -

- 1) De-rating factor of 0.13% per °C is applicable for T<sub>j</sub> below 25°C.
- 2) Double side cooled, single phase; 50Hz, 180° half-sinewave.
- 3) Cathode side cooled, single phase; 50Hz, 180° half-sinewave.
- 4) Double side cooled.
- 5) Half-sinewave, 125°C T<sub>j</sub> initial.
- 6) V<sub>D</sub>=67% V<sub>DRM</sub>, I<sub>TM</sub>=4000A, I<sub>FG</sub>=2A, t<sub>r</sub>≤0.5μs, T<sub>case</sub>=125°C.
- 7) Rated V<sub>DRM</sub>.

## Characteristics

	PARAMETER	MIN.	TYP.	MAX.	TEST CONDITIONS (Note 1)	UNITS
$V_{TM}$	Maximum peak on-state voltage	-	-	2.50	$I_{TM}=3000A$	V
$V_{TM}$	Maximum peak on-state voltage	-	-	4.20	$I_{TM}=7140A$	V
$V_{T0}$	Threshold voltage	-	-	1.26		V
$r_T$	Slope resistance	-	-	0.41		m $\Omega$
dv/dt	Critical rate of rise of off-state voltage	1000	-	-	$V_D=80\% V_{DRM}$ , Linear ramp, gate o/c	V/ $\mu$ s
$I_{DRM}$	Peak off-state current	-	-	200	Rated $V_{DRM}$	mA
$I_{RRM}$	Peak reverse current	-	-	200	Rated $V_{RRM}$	mA
$V_{GT}$	Gate trigger voltage	-	-	3.0	$T_j=25^\circ C$ , $V_D=10V$ , $I_T=3A$	V
$I_{GT}$	Gate trigger current	-	-	300		mA
$I_H$	Holding current	-	-	1000	$T_j=25^\circ C$	mA
$t_{gd}$	Gate controlled turn-on delay time	-	0.7	1.5	$I_{FG}=2A$ , $t_r=0.5\mu s$ , $V_D=67\%V_{DRM}$ , $I_{TM}=2400A$ , $di/dt=10A/\mu s$ , $T_j=25^\circ C$	$\mu$ s
$t_{gt}$	Turn-on time	-	1.5	3.0		
$Q_{rr}$	Recovered Charge	-	11	12	$I_{TM}=3000A$ , $t_p=2000\mu s$ , $di/dt=10A/\mu s$ , $V_r=100V$	mC
$Q_{ra}$	Recovered Charge, 50% chord	-	5.2	-		mC
$I_{rm}$	Reverse recovery current	-	210	220		A
$t_{rr}$	Reverse recovery time, 50% chord	-	50	-		$\mu$ s
$t_q$	Turn-off time	1050	-	1300	$I_{TM}=3000A$ , $t_p=1000\mu s$ , $di/dt=10A/\mu s$ , $V_r=100V$ , $V_{dr}=80\%V_{DRM}$ , $dV_{dr}/dt=20V/\mu s$ (Note 2)	$\mu$ s
		1450	-	1800	$I_{TM}=3000A$ , $t_p=1000\mu s$ , $di/dt=10A/\mu s$ , $V_r=100V$ , $V_{dr}=80\%V_{DRM}$ , $dV_{dr}/dt=200V/\mu s$ (Note 2)	
$R_{thJK}$	Thermal resistance, junction to heatsink	-	-	0.0095	Double side cooled	K/W
		-	-	0.0161	Anode side cooled	K/W
		-	-	0.0239	Cathode side cooled	K/W
F	Mounting force	60	-	70	(Note 3)	kN
$W_t$	Weight	-	1.65	-		kg

Notes: -

- 1) Unless otherwise stated  $T_j=125^\circ C$ .
- 2) Standard test condition for  $t_q$   $dV_{dr}/dt=20V/\mu s$ . For other  $dV_{dr}/dt$  values please consult factory.
- 3) For other clamp forces please consult factory.

## Notes on Ratings and Characteristics

### 1.0 Voltage Grade Table

Voltage Grade	$V_{DRM}$ $V_{DSM}$ $V_{RRM}$ V	$V_{RSM}$ V	$V_D$ $V_R$ DC V
60	6000	6100	3320
65	6500	6600	3600

### 2.0 Extension of Voltage Grades

This report is applicable to other and higher voltage grades when supply has been agreed by Sales/Production.

### 3.0 De-rating Factor

A blocking voltage de-rating factor of 0.13%/°C is applicable to this device for  $T_j$  below 25°C.

### 4.0 Repetitive dv/dt

Standard dv/dt is 1000V/μs.

### 5.0 Snubber Components

When selecting snubber components, care must be taken not to use excessively large values of snubber capacitor or excessively small values of snubber resistor. Such excessive component values may lead to device damage due to the large resultant values of snubber discharge current. If required, please consult the factory for assistance.

### 6.0 Rate of rise of on-state current

The maximum un-primed rate of rise of on-state current must not exceed 1000A/μs at any time during turn-on on a non-repetitive basis. For repetitive performance, the on-state rate of rise of current must not exceed 200A/μs at any time during turn-on. Note that these values of rate of rise of current apply to the total device current including that from any local snubber network.

### 7.0 Gate Drive

The nominal requirement for a typical gate drive is illustrated below. An open circuit voltage of at least 30V is assumed. This gate drive must be applied when using the full di/dt capability of the device.

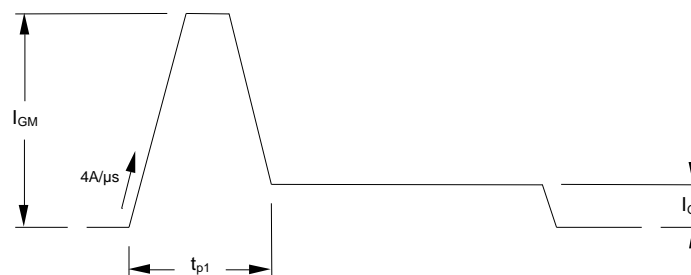

The magnitude of  $I_{GM}$  should be between five and ten times  $I_{GT}$ , which is shown on page 2. Its duration ( $t_{p1}$ ) should be 20μs or sufficient to allow the anode current to reach ten times  $I_L$ , whichever is greater. Otherwise, an increase in pulse current could be needed to supply the necessary charge to trigger. The 'back-porch' current  $I_G$  should remain flowing for the same duration as the anode current and have a magnitude in the order of 1.5 times  $I_{GT}$ .

## 8.0 Computer Modelling Parameters

### 8.1 Device Dissipation Calculations

$$I_{AV} = \frac{-V_{T0} + \sqrt{V_{T0}^2 + 4 \cdot ff^2 \cdot r_T \cdot W_{AV}}}{2 \cdot ff^2 \cdot r_T} \quad \text{and:} \quad W_{AV} = \frac{\Delta T}{R_{th}}$$

$$\Delta T = T_{j\max} - T_{Hs}$$

Where  $V_{T0}=1.26V$ ,  $r_T=0.41m\Omega$ ,

$R_{th}$  = Supplementary thermal impedance, see table below.

$ff$  = Form factor, see table below.

Supplementary Thermal Impedance							
Conduction Angle	30°	60°	90°	120°	180°	270°	d.c.
Square wave Double Side Cooled	0.0103	0.0102	0.0101	0.0100	0.0099	0.0097	0.0095
Square wave Anode Side Cooled	0.0169	0.0168	0.0167	0.0166	0.0164	0.0162	0.0161
Square wave Cathode Side Cooled	0.0247	0.0246	0.0245	0.0244	0.0242	0.0240	0.0239
Sine wave Double Side Cooled	0.0102	0.0101	0.0100	0.0099	0.0097		
Sine wave Anode Side Cooled	0.0168	0.0167	0.0166	0.0165	0.0163		
Sine wave Cathode Side Cooled	0.0246	0.0245	0.0244	0.0243	0.0240		

Form Factors							
Conduction Angle	30°	60°	90°	120°	180°	270°	d.c.
Square wave	3.46	2.45	2	1.73	1.41	1.15	1
Sine wave	3.98	2.78	2.22	1.88	1.57		

### 8.2 Calculating $V_T$ using ABCD Coefficients

The on-state characteristic  $I_T$  vs.  $V_T$ , on page 7 is represented in two ways;

- (i) the well established  $V_o$  and  $r_s$  tangent used for rating purposes and
- (ii) a set of constants A, B, C, D, forming the coefficients of the representative equation for  $V_T$  in terms of  $I_T$  given below:

$$V_T = A + B \cdot \ln(I_T) + C \cdot I_T + D \cdot \sqrt{I_T}$$

The constants, derived by curve fitting software, are given below for both hot and cold characteristics. The resulting values for  $V_T$  agree with the true device characteristic over a current range, which is limited to that plotted.

25°C Coefficients		125°C Coefficients	
A	1.494611104	A	-0.171434796
B	-0.07333551	B	0.2655207
C	$1.83115 \times 10^{-4}$	C	$4.68308 \times 10^{-4}$
D	0.01395872	D	-0.01568942

### 8.3 D.C. Thermal Impedance Calculation

$$r_t = \sum_{p=1}^{p=n} r_p \cdot \left( 1 - e^{-\frac{t}{\tau_p}} \right)$$

Where  $p = 1$  to  $n$ ,  $n$  is the number of terms in the series and:

$t$  = Duration of heating pulse in seconds.

$r_t$  = Thermal resistance at time  $t$ .

$r_p$  = Amplitude of  $p$ th term.

$\tau_p$  = Time Constant of  $r_{th}$  term.

D.C. Double Side Cooled				
Term	1	2	3	4
$r_p$	$4.908987 \times 10^{-3}$	$2.817921 \times 10^{-3}$	$1.080935 \times 10^{-3}$	$6.885043 \times 10^{-4}$
$\tau_p$	1.620672	0.2561638	0.09508523	0.01420279

D.C. Anode Side Cooled					
Term	1	2	3	4	5
$r_p$	$9.397610 \times 10^{-3}$	$2.466025 \times 10^{-3}$	$3.447569 \times 10^{-3}$	6.9974225	$5.633071 \times 10^{-5}$
$\tau_p$	8.818299	0.9614620	0.1834538	0.01428571	0.01152822

D.C. Cathode Side Cooled				
Term	1	2	3	4
$r_p$	0.01892986	$3.369725 \times 10^{-3}$	$9.564183 \times 10^{-4}$	$5.956184 \times 10^{-4}$
$\tau_p$	8.626916	0.2589928	0.07793290	0.01183436

### 9.0 Reverse recovery ratings

(i)  $Q_{ra}$  is based on 50%  $I_{RM}$  chord as shown in Fig. 1

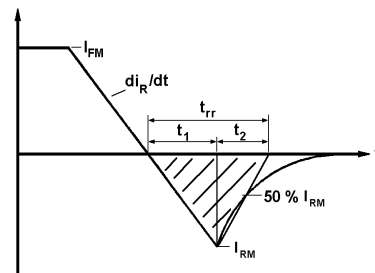

**Fig. 1**

(ii)  $Q_{rr}$  is based on a  $600 \mu s$  integration time i.e.

$$Q_{rr} = \int_0^{600 \mu s} i_{rr} \cdot dt$$

(iii)

$$K \text{ Factor} = \frac{t_1}{t_2}$$

**Curves**

Figure 1 - On-state characteristics of Limit device

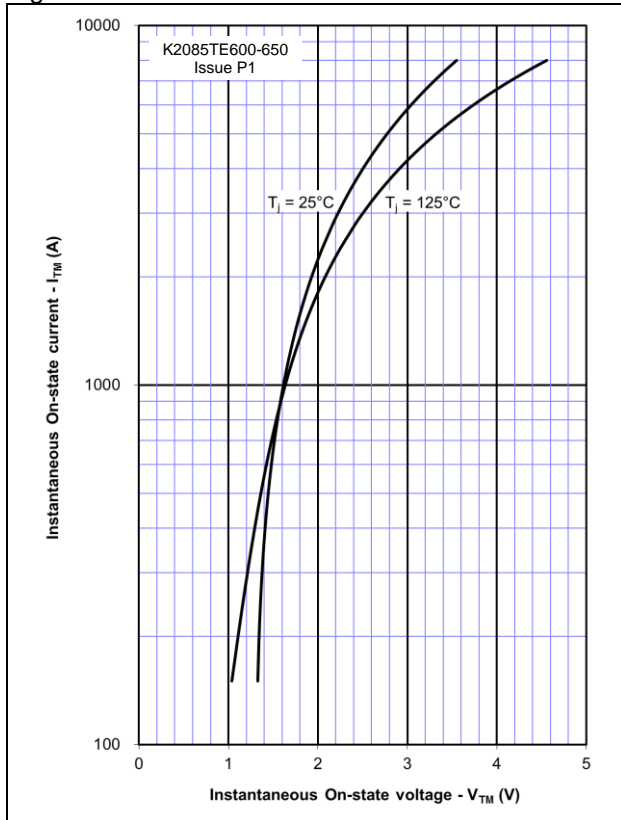

Figure 2 - Transient Thermal Impedance

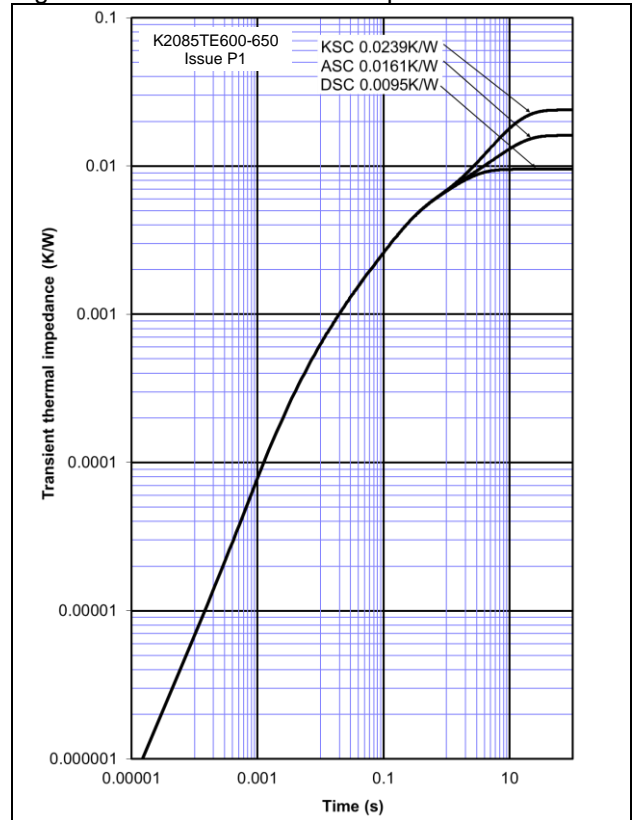

Figure 3 - Gate Characteristics - Trigger Limits

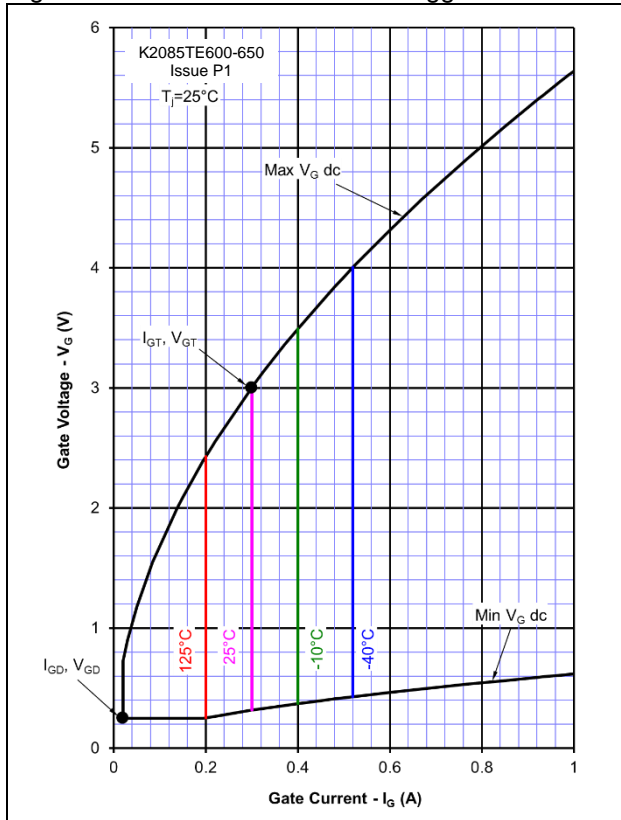

Figure 4 - Gate Characteristics - Power Curves

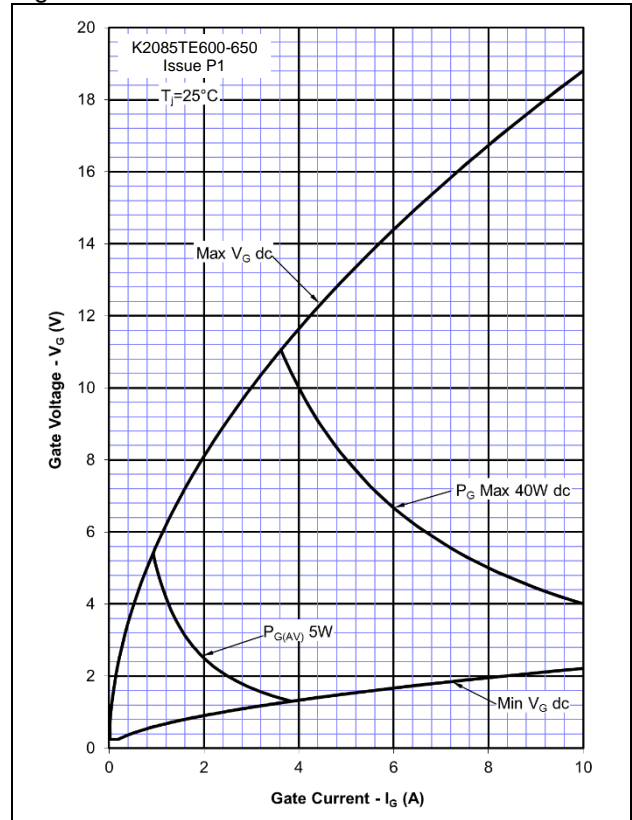

Figure 5 – Recovered Charge,  $Q_{rr}$

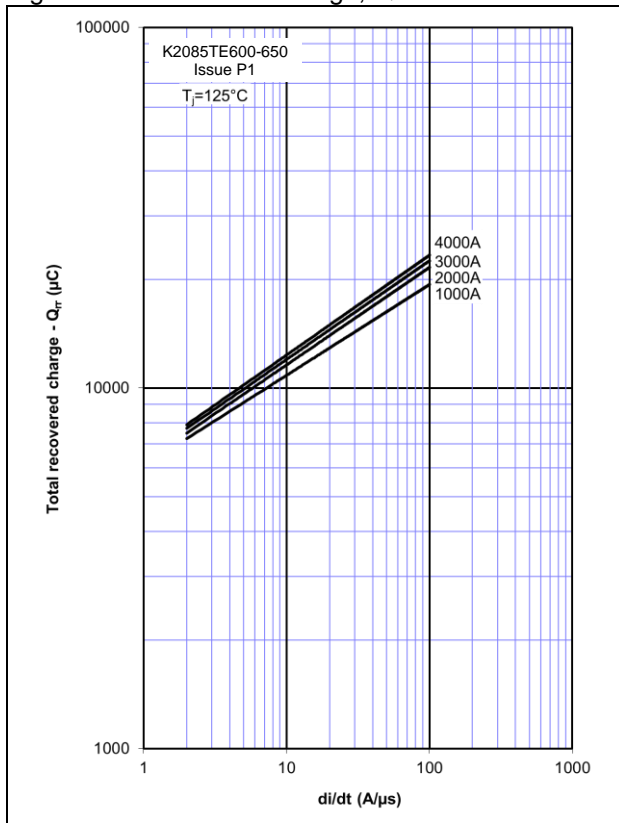

Figure 6 – Recovered charge,  $Q_{ra}$  (50% chord)

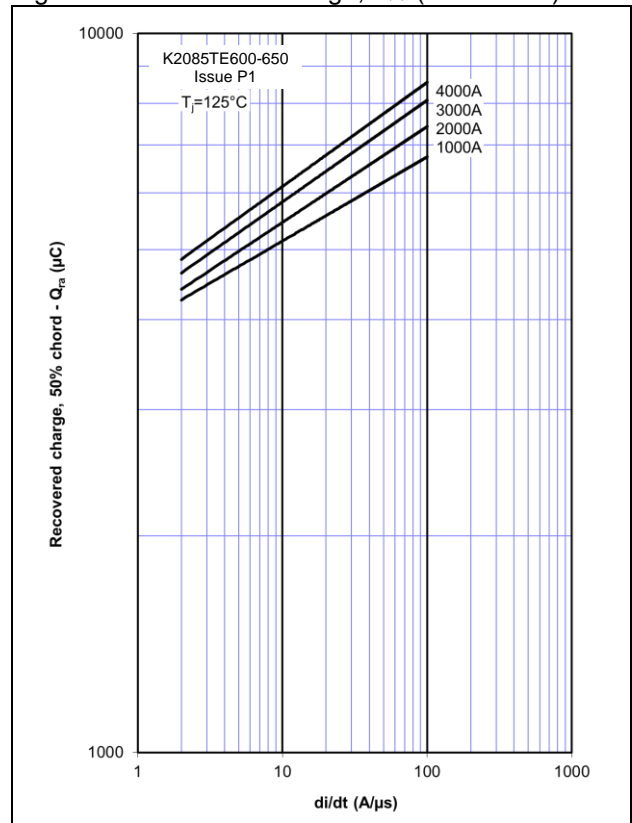

Figure 7 – Reverse recovery current,  $I_{rm}$

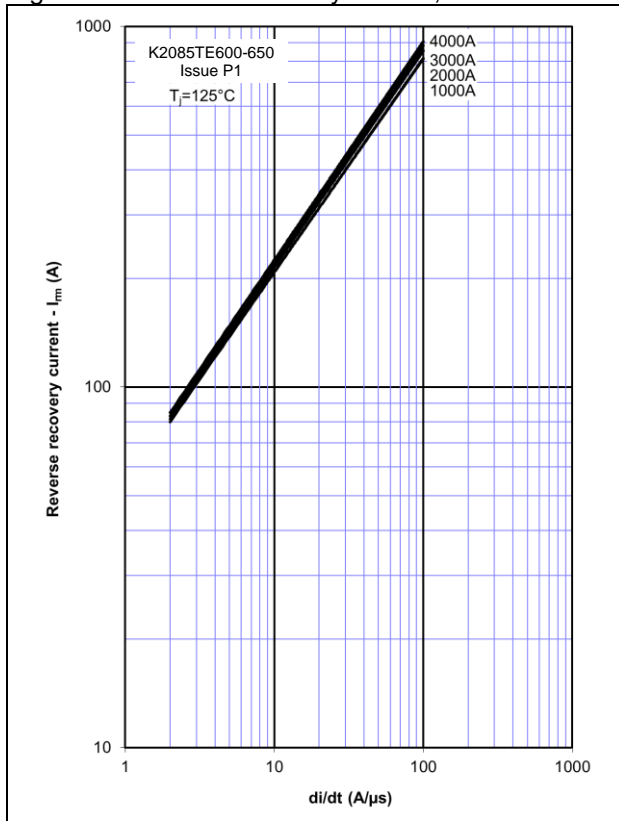

Figure 8 – Reverse recovery time,  $t_{rr}$

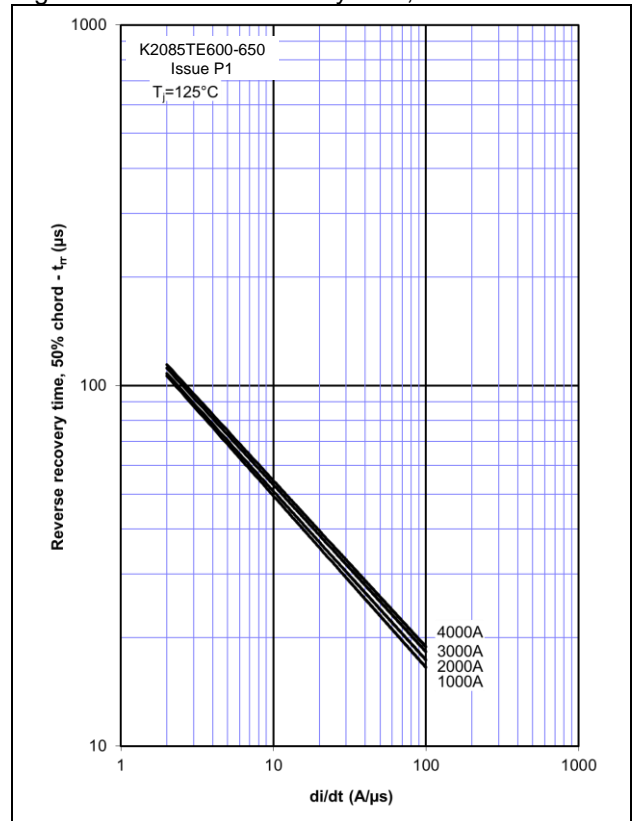

Figure 9 – On-state current vs. Power dissipation – Double Side Cooled (Sine wave)

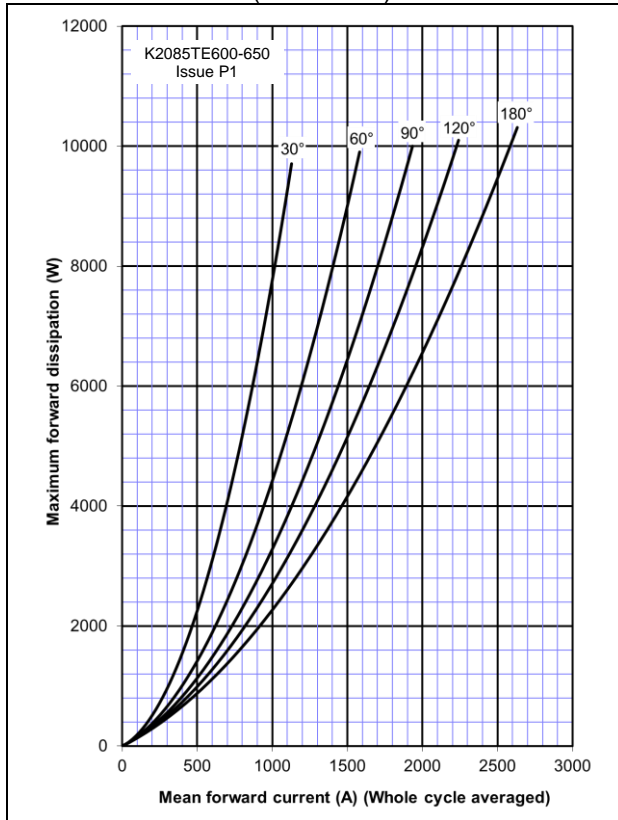

Figure 10 – On-state current vs. Heatsink temperature - Double Side Cooled (Sine wave)

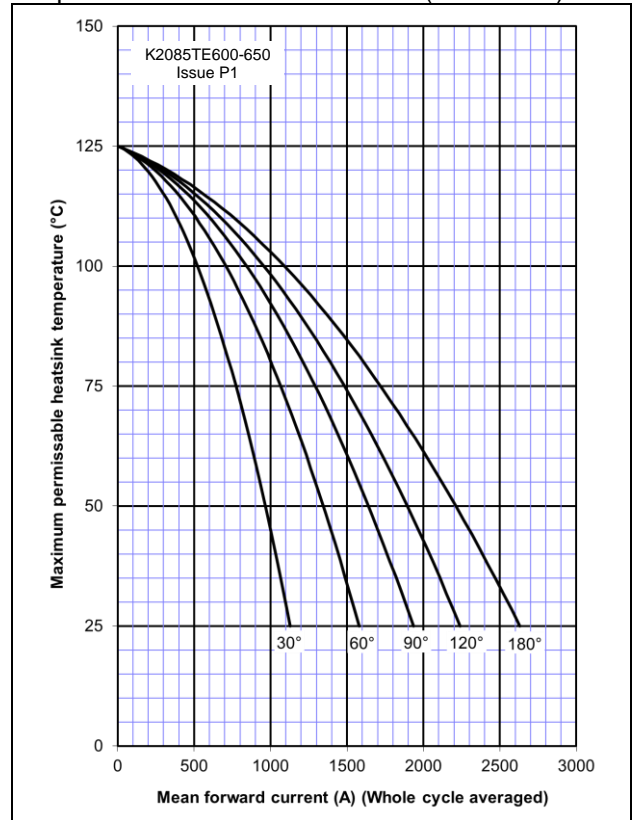

Figure 11 – On-state current vs. Power dissipation – Double Side Cooled (Square wave)

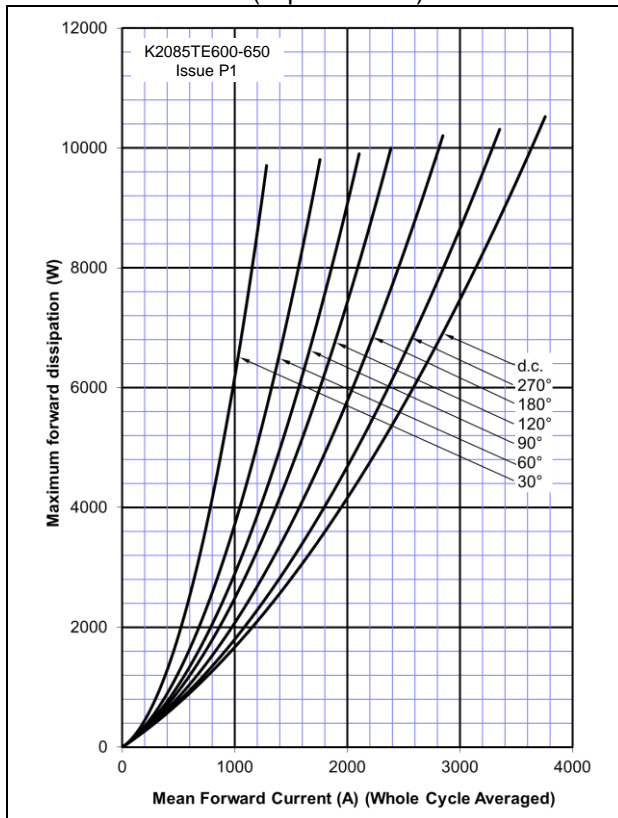

Figure 12 – On-state current vs. Heatsink temperature - Double Side Cooled (Square wave)

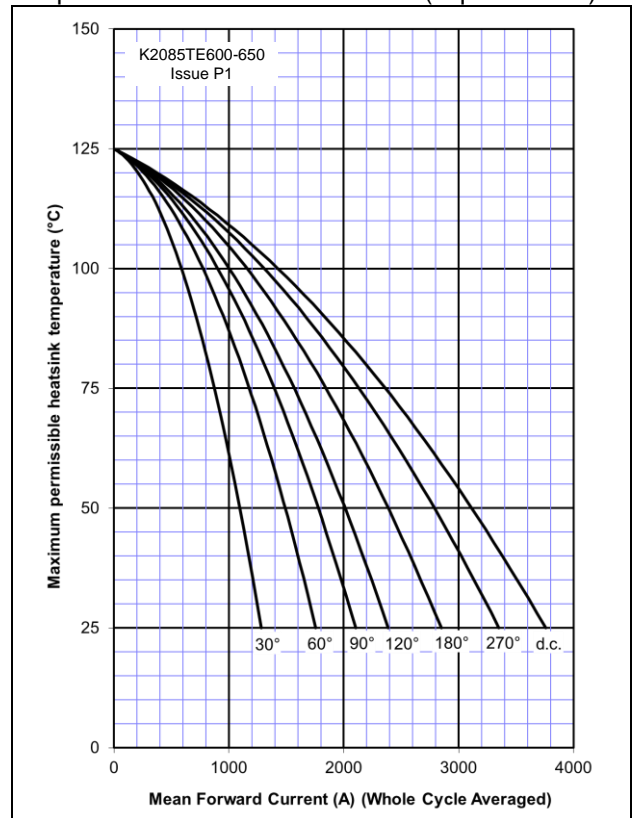



Figure 13 – On-state current vs. Power dissipation – Cathode Side Cooled (Sine wave)

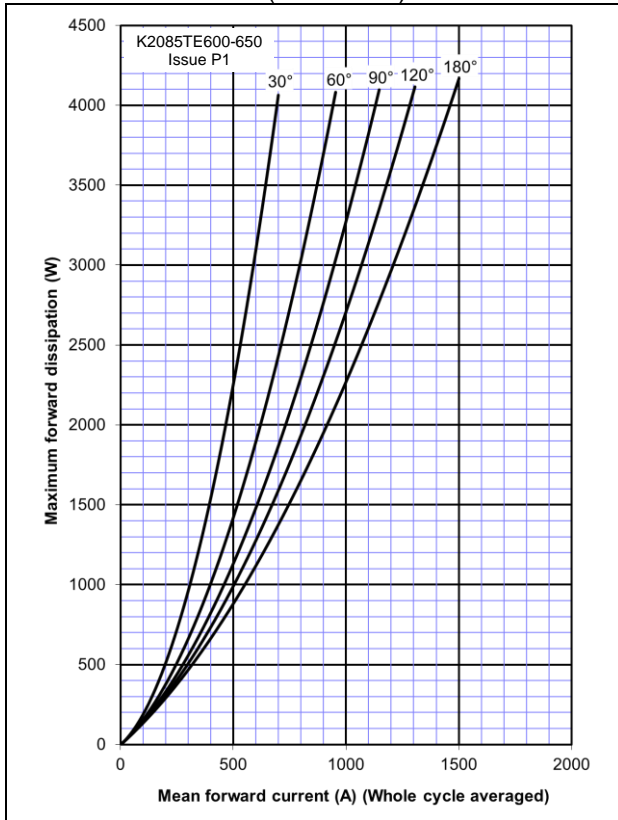

Figure 14 – On-state current vs. Heatsink temperature - Cathode Side Cooled (Sine wave)

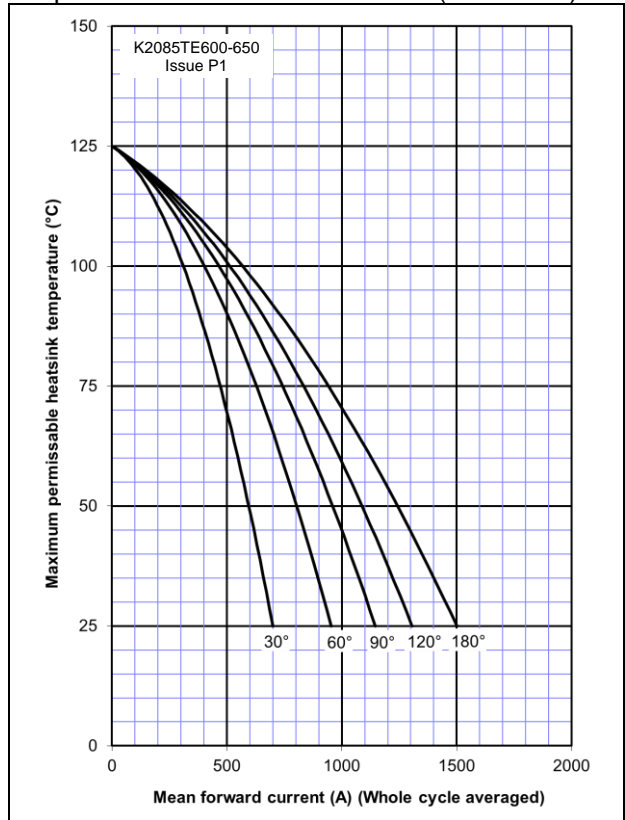

Figure 15 – On-state current vs. Power dissipation – Cathode Side Cooled (Square wave)

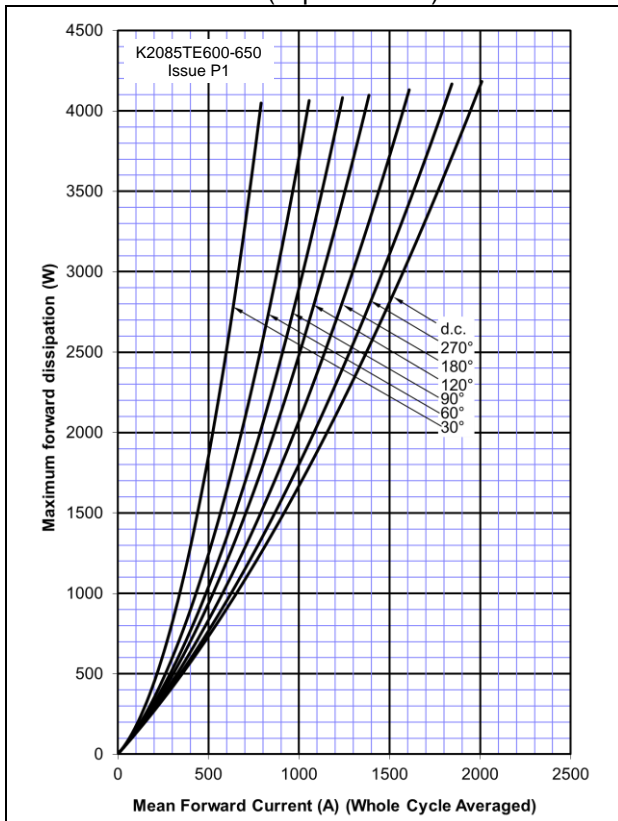

Figure 16 – On-state current vs. Heatsink temperature - Cathode Side Cooled (Square wave)

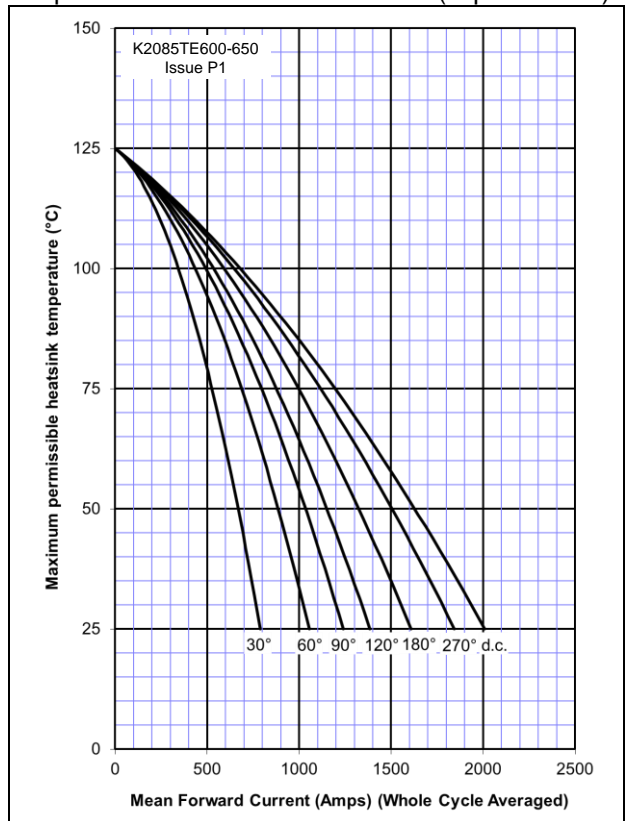
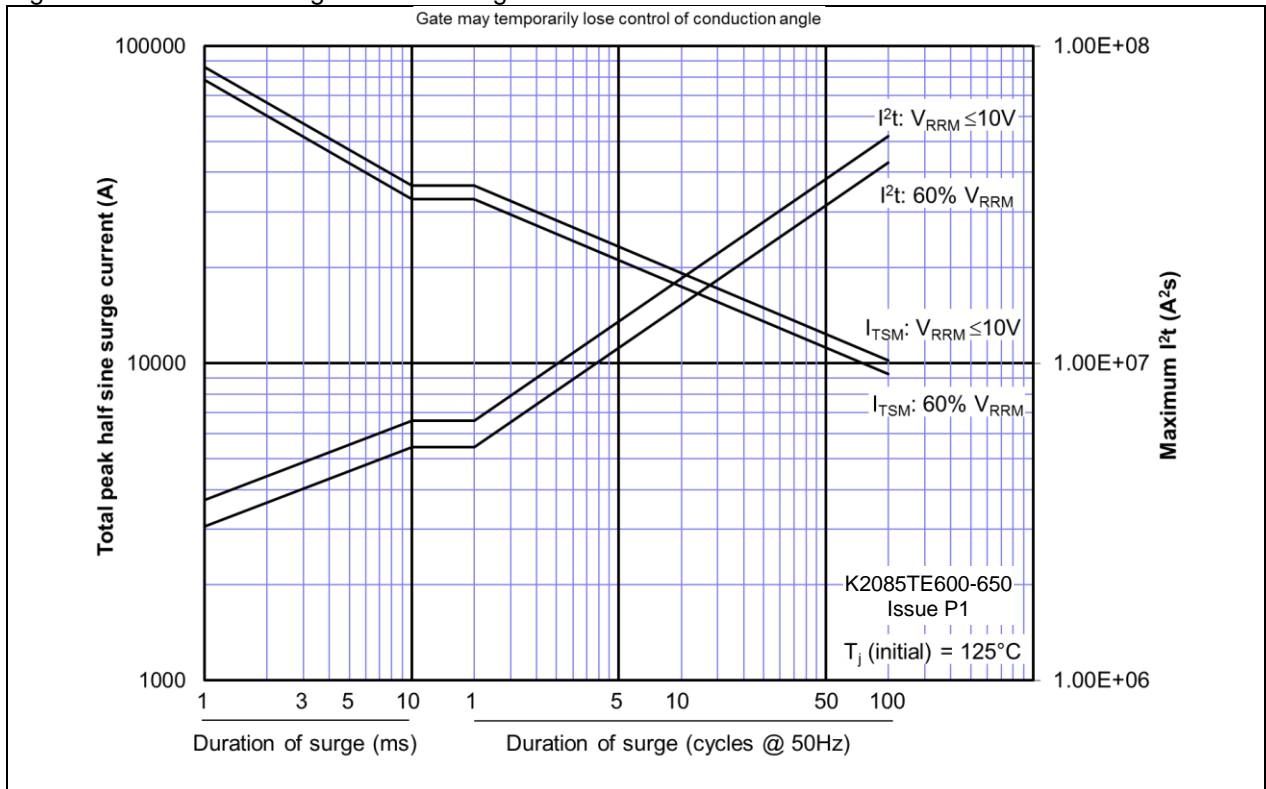
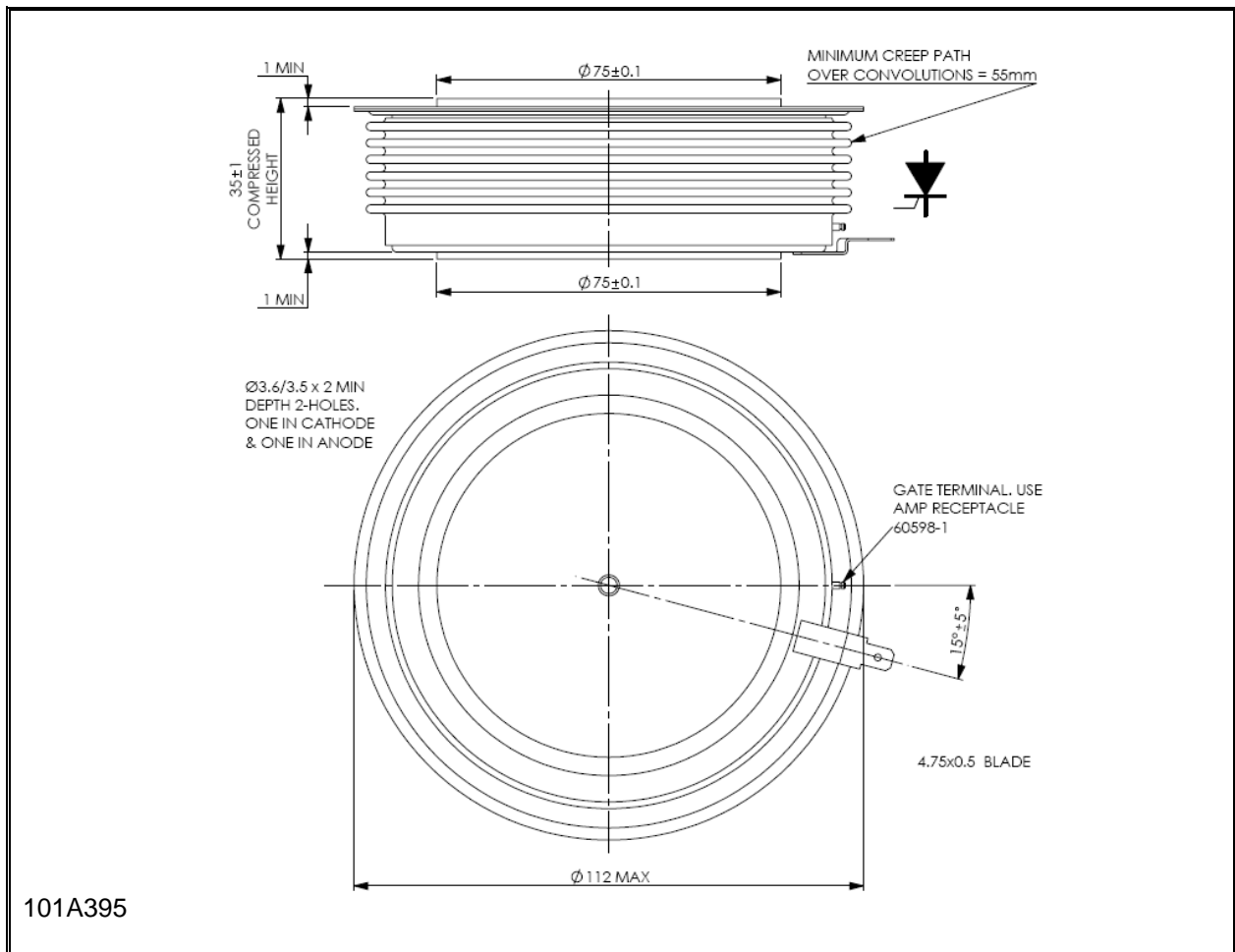

Figure 17 – Maximum surge and I<sup>2</sup>t Ratings



**Outline Drawing & Ordering Information**

**ORDERING INFORMATION**

(Please quote 10 digit code as below)

<b>K2085</b>	<b>TE</b>	<b>◆◆</b>	<b>0</b>
Fixed Type Code	Fixed Outline Code	Voltage Code V <sub>DRM</sub> & V <sub>RRM</sub> /100 60 & 65	Fixed turn-off time code

 Typical order code: K2085TE650 – 6500V V<sub>DRM</sub>, V<sub>RRM</sub>, 1000V/µs dv/dt, 35mm clamp height capsule.

**IXYS Semiconductor GmbH**

 Edisonstraße 15  
 D-68623 Lampertheim  
 Tel: +49 6206 503-0  
 Fax: +49 6206 503-627  
 E-mail: [marcom@ixys.de](mailto:marcom@ixys.de)

**IXYS UK Westcode Ltd**

 Langley Park Way, Langley Park,  
 Chippenham, Wiltshire, SN15 1GE.  
 Tel: +44 (0)1249 444524  
 E-mail: [sales@ixysuk.com](mailto:sales@ixysuk.com)
**IXYS Corporation**

 3540 Bassett Street  
 Santa Clara CA 95054 USA  
 Tel: +1 (408) 982 0700  
 Fax: +1 (408) 496 0670  
 E-mail: [sales@ixys.net](mailto:sales@ixys.net)

[www.littelfuse.com](http://www.littelfuse.com)

[www.ixysuk.com](http://www.ixysuk.com)

[www.ixys.com](http://www.ixys.com)

**IXYS Long Beach Inc**

 2500 Mira Mar Ave,  
 Long Beach CA 90815  
 Tel: +1 (562) 296 6584  
 Fax: +1 (562) 296 6585  
 E-mail: [service@ixyslongbeach.com](mailto:service@ixyslongbeach.com)

The information contained herein is confidential and is protected by Copyright. The information may not be used or disclosed except with the written permission of and in the manner permitted by the proprietors IXYS UK Westcode Ltd.

© IXYS UK Westcode Ltd.

In the interest of product improvement, IXYS UK Westcode reserves the right to change specifications at any time without prior notice.

Devices with a suffix code (2-letter, 3-letter or letter/digit/letter combination) added to their generic code are not necessarily subject to the conditions and limits contained in this report.



---

Disclaimer Notice - Information furnished is believed to be accurate and reliable. However, users should independently evaluate the suitability of and test each product selected for their own applications. Littelfuse products are not designed for, and may not be used in, all applications. Read complete Disclaimer Notice at [www.littelfuse.com/disclaimer-electronics](http://www.littelfuse.com/disclaimer-electronics).