

Medium Voltage Thyristor

Types K1197NC280 to K1197NC320

Old Type No.: P480CH20-32

Absolute Maximum Ratings

	VOLTAGE RATINGS	MAXIMUM LIMITS	UNITS
V_{DRM}	Repetitive peak off-state voltage, (note 1)	2800-3200	V
V_{DSM}	Non-repetitive peak off-state voltage, (note 1)	2800-3200	V
V_{RRM}	Repetitive peak reverse voltage, (note 1)	2800-3200	V
V_{RSM}	Non-repetitive peak reverse voltage, (note 1)	2900-3300	V

	OTHER RATINGS	MAXIMUM LIMITS	UNITS
$I_{T(AV)M}$	Maximum average on-state current, $T_{sink}=55^{\circ}C$, (note 2)	1197	A
$I_{T(AV)M}$	Maximum average on-state current. $T_{sink}=85^{\circ}C$, (note 2)	803	A
$I_{T(AV)M}$	Maximum average on-state current. $T_{sink}=85^{\circ}C$, (note 3)	471	A
$I_{T(RMS)}$	Nominal RMS on-state current, $T_{sink}=25^{\circ}C$, (note 2)	2392	A
$I_{T(d.c.)}$	D.C. on-state current, $T_{sink}=25^{\circ}C$, (note 4)	2003	A
I_{TSM}	Peak non-repetitive surge $t_p=10ms$, $V_{rm}=0.6V_{RRM}$, (note 5)	10.65	kA
I_{TSM2}	Peak non-repetitive surge $t_p=10ms$, $V_{rm}\leq 10V$, (note 5)	11.7	kA
I^2t	I^2t capacity for fusing $t_p=10ms$, $V_{rm}=0.6V_{RRM}$, (note 5)	567×10^3	A^2s
I^2t	I^2t capacity for fusing $t_p=10ms$, $V_{rm}\leq 10V$, (note 5)	684×10^3	A^2s
$(di/dt)_{cr}$	Critical rate of rise of on-state current (repetitive), (Note 6)	300	$A/\mu s$
	Critical rate of rise of on-state current (non-repetitive), (Note 6)	600	$A/\mu s$
V_{RGM}	Peak reverse gate voltage	5	V
$P_{G(AV)}$	Mean forward gate power	4	W
P_{GM}	Peak forward gate power	30	W
$T_{j op}$	Operating temperature range	-40 to +125	$^{\circ}C$
T_{stg}	Storage temperature range	-40 to +150	$^{\circ}C$

Notes:-

- 1) De-rating factor of 0.13% per $^{\circ}C$ is applicable for T_j below $25^{\circ}C$.
- 2) Double side cooled, single phase; 50Hz, 180° half-sinewave.
- 3) Single side cooled, single phase; 50Hz, 180° half-sinewave.
- 4) Double side cooled.
- 5) Half-sinewave, $125^{\circ}C$ T_j initial.
- 6) $V_D=67\% V_{DRM}$, $I_{FG}=2A$, $t_f\leq 0.5\mu s$, $T_{case}=125^{\circ}C$.

Characteristics

	PARAMETER	MIN.	TYP.	MAX.	TEST CONDITIONS (Note 1)	UNITS
V _{TM}	Maximum peak on-state voltage	-	-	2.1	I _{TM} =2000A	V
V _{T0}	Threshold voltage	-	-	1.335		V
r _T	Slope resistance	-	-	0.372		mΩ
(dv/dt) _{cr}	Critical rate of rise of off-state voltage	1000	-	-	V _D =80% V _{DRM} , linear ramp, gate o/c	V/μs
I _{DRM}	Peak off-state current	-	-	100	Rated V _{DRM}	mA
I _{RPM}	Peak reverse current	-	-	100	Rated V _{RPM}	mA
V _{tr}	On-state recovery voltage	-	10.0	-	I _T =3300A, t _p =10ms, T _{case} =25°C	V
V _{GT}	Gate trigger voltage	-	-	3.0	T _j =25°C V _D =10V, I _T =3A	V
I _{GT}	Gate trigger current	-	-	300		mA
V _{GD}	Gate non-trigger voltage	-	-	0.25	Rated V _{DRM}	V
I _H	Holding current	-	-	1000	T _j =25°C	mA
t _{gd}	Gate-controlled turn-on delay time	-	0.5	1.0	V _D =67% V _{DRM} , I _T =1000A, di/dt=10A/μs,	μs
t _{gt}	Turn-on time	-	1.5	3.0	I _{FG} =2A, t _r =0.5μs, T _j =25°C	μs
Q _{rr}	Recovered charge	-	2700	-		μC
Q _{ra}	Recovered charge, 50% Chord	-	1400	1600	I _{TM} =1000A, t _p =1000μs, di/dt=10A/μs,	μC
I _{rm}	Reverse recovery current	-	100	-	V _r =50V	A
t _{rr}	Reverse recovery time, 50% Chord	-	28	-		μs
t _q	Turn-off time	-	250	-	I _{TM} =1000A, t _p =1000μs, di/dt=10A/μs, V _r =50V, V _{dr} =80%V _{DRM} , dV _{dr} /dt=20V/μs	μs
		-	350	-	I _{TM} =1000A, t _p =1000μs, di/dt=10A/μs, V _r =50V, V _{dr} =80%V _{DRM} , dV _{dr} /dt=200V/μs	
R _{thJK}	Thermal resistance, junction to heatsink	-	-	0.024	Double side cooled	K/W
		-	-	0.048	Single side cooled	K/W
F	Mounting force	19	-	26		kN
W _t	Weight	-	510	-		g

Notes:-

1) Unless otherwise indicated T_j=125°C.

Notes on Ratings and Characteristics

1.0 Voltage Grade Table

Voltage Grade	V_{DRM} V_{DSM} V_{RRM} V	V_{RSM} V	V_D V_R DC V
28	2800	2900	1650
30	3000	3100	1750
32	3200	3300	1800

2.0 Extension of Voltage Grades

This report is applicable to other voltage grades when supply has been agreed by Sales/Production.

3.0 De-rating Factor

A blocking voltage de-rating factor of 0.13%/°C is applicable to this device for T_j below 25°C.

4.0 Repetitive dv/dt

Standard dv/dt is 1000V/μs.

5.0 Frequency Ratings

The curves illustrated in figures 17 & 18 are for guidance only and are superseded by the maximum ratings shown on page 1. For operation above line frequency, please consult the factory for assistance.

6.0 Snubber Components

When selecting snubber components, care must be taken not to use excessively large values of snubber capacitor or excessively small values of snubber resistor. Such excessive component values may lead to device damage due to the large resultant values of snubber discharge current. If required, please consult the factory for assistance.

7.0 Rate of rise of on-state current

The maximum un-primed rate of rise of on-state current must not exceed 600A/μs at any time during turn-on on a non-repetitive basis. For repetitive performance, the on-state rate of rise of current must not exceed 300A/μs at any time during turn-on. Note that these values of rate of rise of current apply to the total device current including that from any local snubber network.

8.0 Square wave frequency ratings

These ratings are given for load component rate of rise of on-state current of 50A/μs.

9.0 Duty cycle lines

The 100% duty cycle is represented on the frequency ratings by a straight line. Other duties can be included as parallel to the first.

0.0 Gate Drive

The nominal requirement for a typical gate drive is illustrated below. An open circuit voltage of at least 30V is assumed. This gate drive must be applied when using the full di/dt capability of the device.

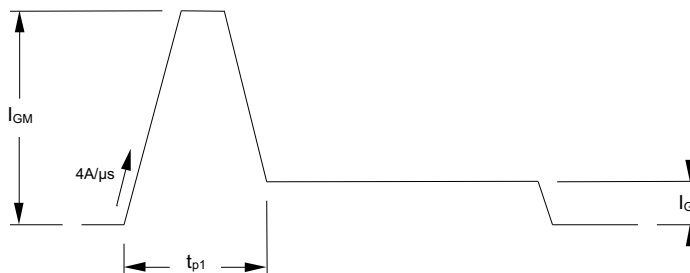

The magnitude of I_{GM} should be between five and ten times I_{GT} , which is shown on page 2. Its duration (t_{p1}) should be 20μs or sufficient to allow the anode current to reach ten times I_L , whichever is greater. Otherwise, an increase in pulse current could be needed to supply the necessary charge to trigger. The 'back-porch' current I_G should remain flowing for the same duration as the anode current and have a magnitude in the order of 1.5 times I_{GT} .

11.0 Computer Modelling Parameters

11.1 Device Dissipation Calculations

$$I_{AV} = \frac{-V_{T0} + \sqrt{V_{T0}^2 + 4 \cdot ff \cdot r_T \cdot W_{AV}}}{2 \cdot ff \cdot r_T} \quad \text{and:} \quad W_{AV} = \frac{\Delta T}{R_{th}}$$

$$\Delta T = T_{j\max} - T_{Hs}$$

Where $V_{T0}=1.335V$, $r_T=0.372m\Omega$,

R_{th} = Supplementary thermal impedance, see table below and

ff = Form factor, see table below.

Supplementary Thermal Impedance							
Conduction Angle	30°	60°	90°	120°	180°	270°	d.c.
Square wave Double Side Cooled	0.03047	0.03035	0.02857	0.02733	0.02569	0.0242	0.024
Square wave Single Side Cooled	0.05823	0.0577	0.05408	0.05286	0.05121	0.0497	0.048
Sine wave Double Side Cooled	0.0303	0.0275	0.0262	0.02524	0.024		
Sine wave Single Side Cooled	0.05588	0.05323	0.05186	0.05089	0.048		

Form Factors							
Conduction Angle	30°	60°	90°	120°	180°	270°	d.c.
Square wave	3.464	2.449	2	1.732	1.414	1.149	1
Sine wave	3.98	2.778	2.22	1.879	1.57		

11.2 Calculating V_T using ABCD Coefficients

The on-state characteristic I_T vs. V_T , on page 6 is represented in two ways;

- (i) the well established V_{T0} and r_T tangent used for rating purposes and
- (ii) a set of constants A, B, C, D, forming the coefficients of the representative equation for V_T in terms of I_T given below:

$$V_T = A + B \cdot \ln(I_T) + C \cdot I_T + D \cdot \sqrt{I_T}$$

The constants, derived by curve fitting software, are given below for hot characteristics. The resulting values for V_T agree with the true device characteristic over a current range, which is limited to that plotted.

125°C Coefficients	
A	0.89335367
B	0.03826203
C	2.5045×10^{-4}
D	9.27801×10^{-3}

11.3 D.C. Thermal Impedance Calculation

$$r_t = \sum_{p=1}^{p=n} r_p \cdot \left(1 - e^{\frac{-t}{\tau_p}} \right)$$

Where $p = 1$ to n , n is the number of terms in the series and:

- t = Duration of heating pulse in seconds.
- r_t = Thermal resistance at time t .
- r_p = Amplitude of p^{th} term.
- τ_p = Time Constant of r^{th} term.

The coefficients for this device are shown in the tables below:

D.C. Double Side Cooled					
Term	1	2	3	4	5
r_p	0.01248	6.216×10^{-3}	1.939×10^{-3}	1.527×10^{-3}	1.038×10^{-3}
τ_p	0.884	0.1221	0.03612	7.612×10^{-3}	1.93×10^{-3}

D.C. Single Side Cooled							
Term	1	2	3	4	5	6	7
r_p	0.02836	5.574×10^{-3}	3.588×10^{-3}	6.222×10^{-3}	2.04×10^{-3}	1.675×10^{-3}	1.258×10^{-3}
τ_p	6.345	3.55	0.582	0.132	0.0496	0.01015	2.225×10^{-3}

Curves

Figure 1 - On-state characteristics of Limit device

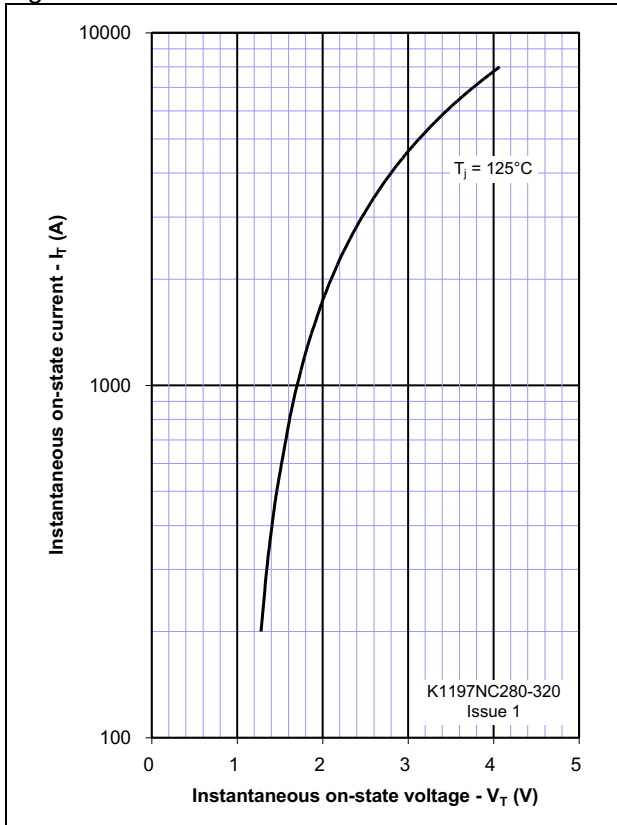

Figure 2 - Transient thermal impedance

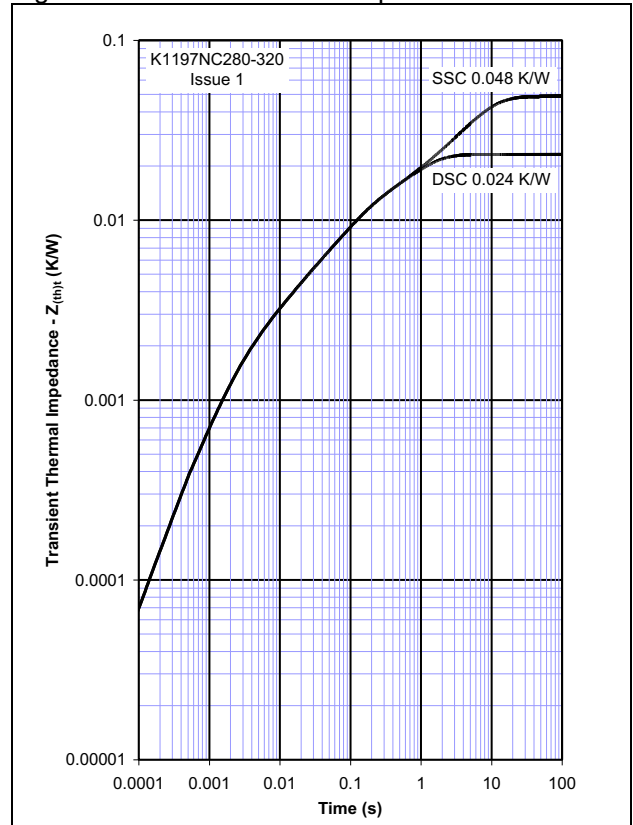

Figure 3 - Gate characteristics - Trigger limits

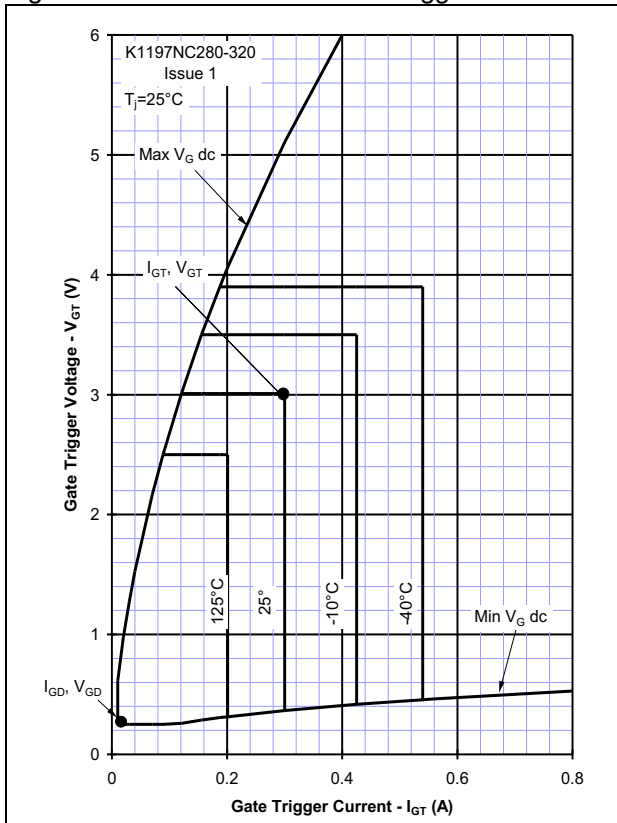

Figure 4 - Gate characteristics - Power curves

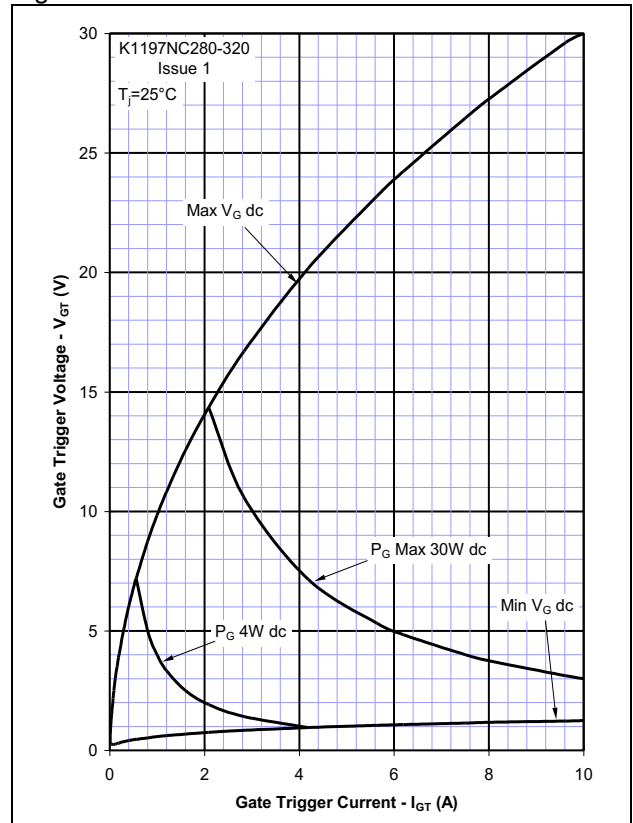

Figure 5 - Total recovered charge, Q_{rr}

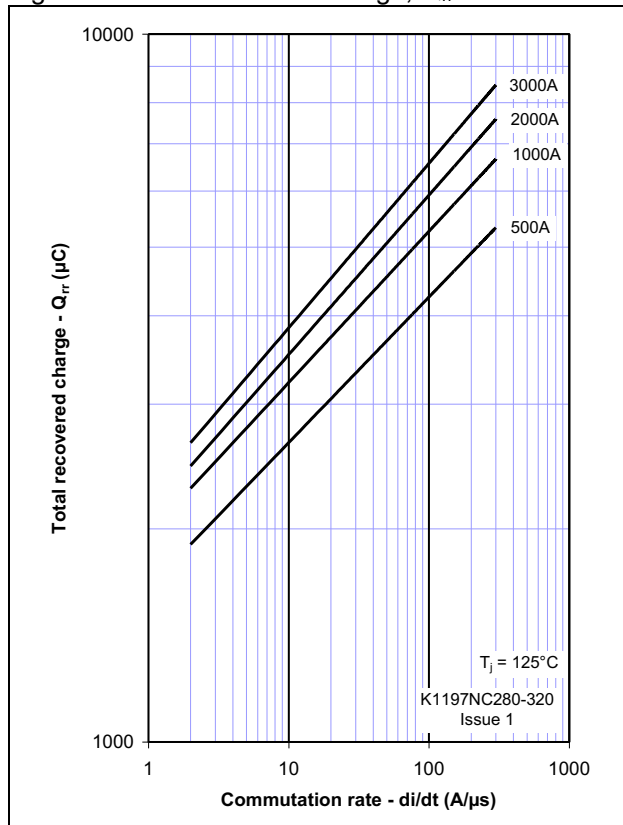

Figure 6 - Recovered charge, Q_{ra} (50% chord)

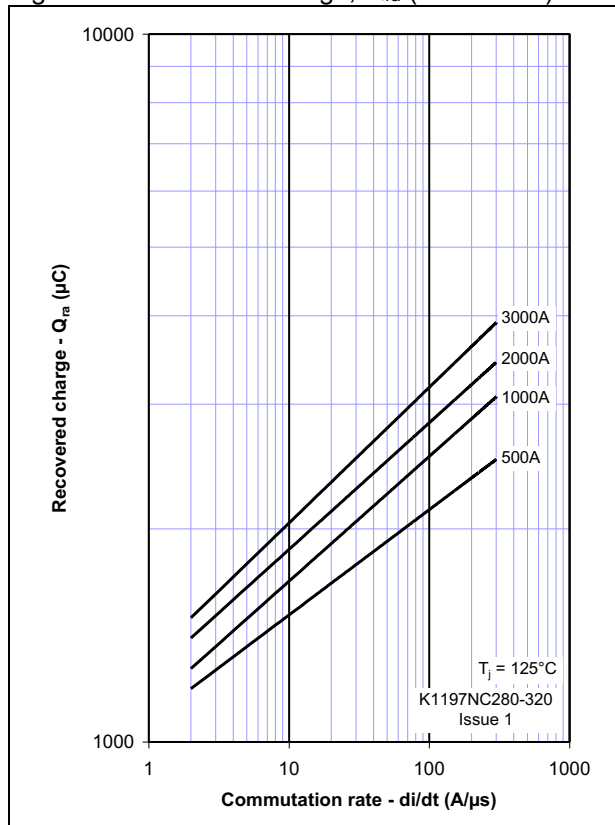

Figure 7 - Peak reverse recovery current, I_{rm}

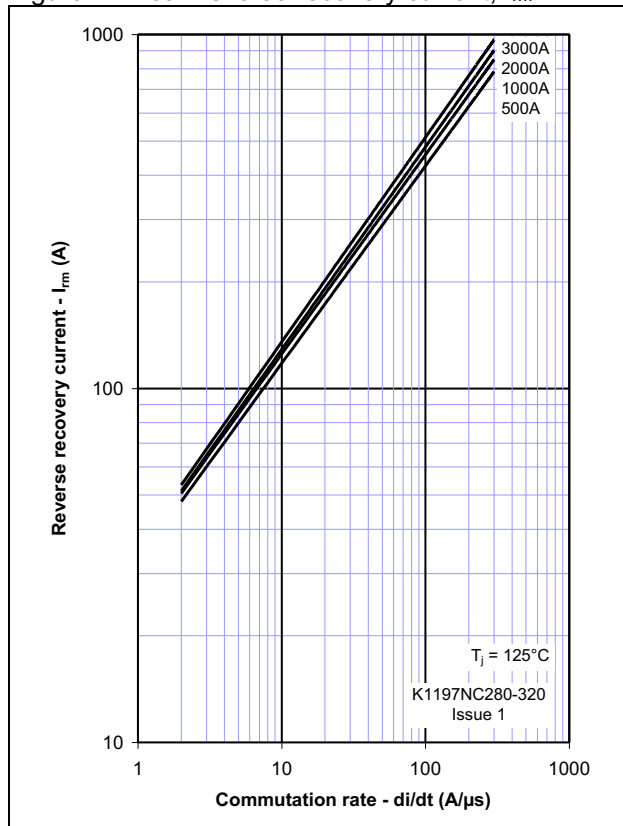

Figure 8 - Maximum recovery time, t_{rr} (50% chord)

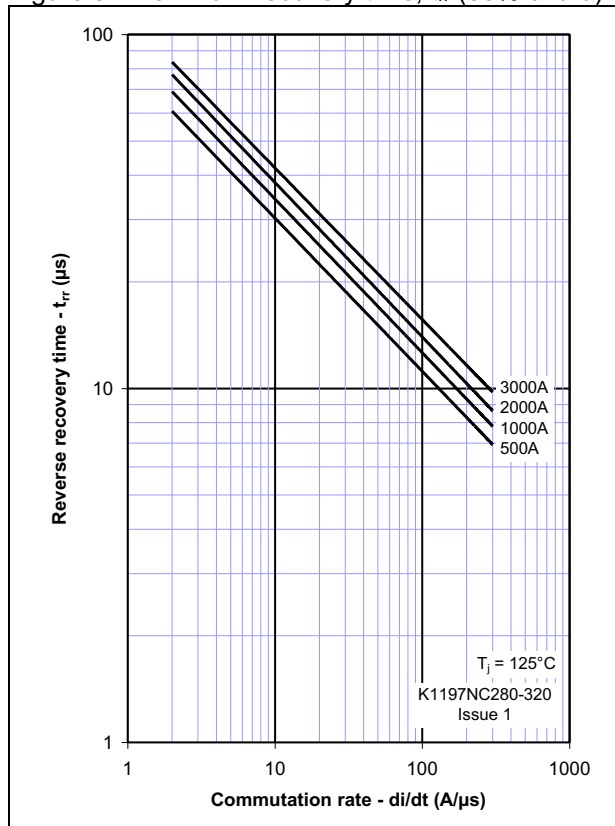

Figure 9 – On-state current vs. Power dissipation – Double Side Cooled (Sine wave)

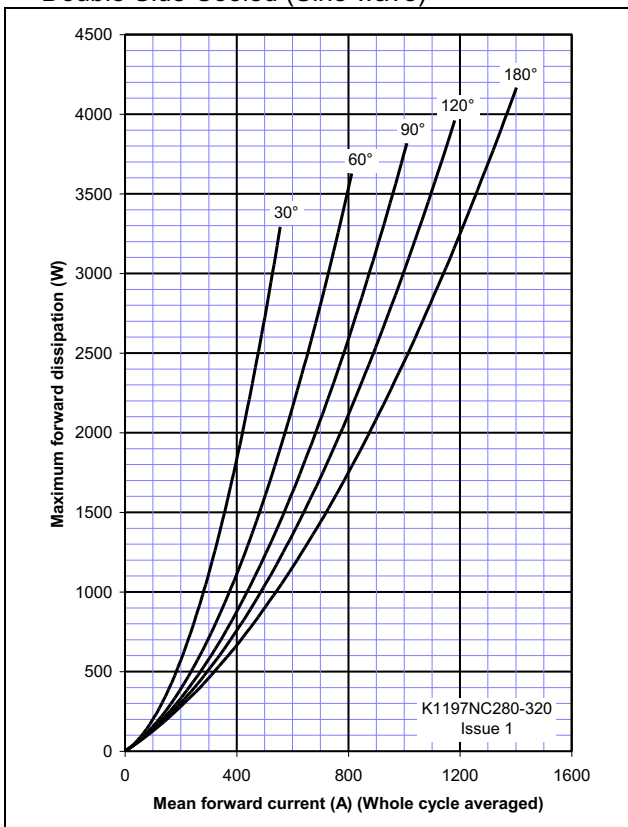

Figure 10 – On-state current vs. Heatsink temperature - Double Side Cooled (Sine wave)

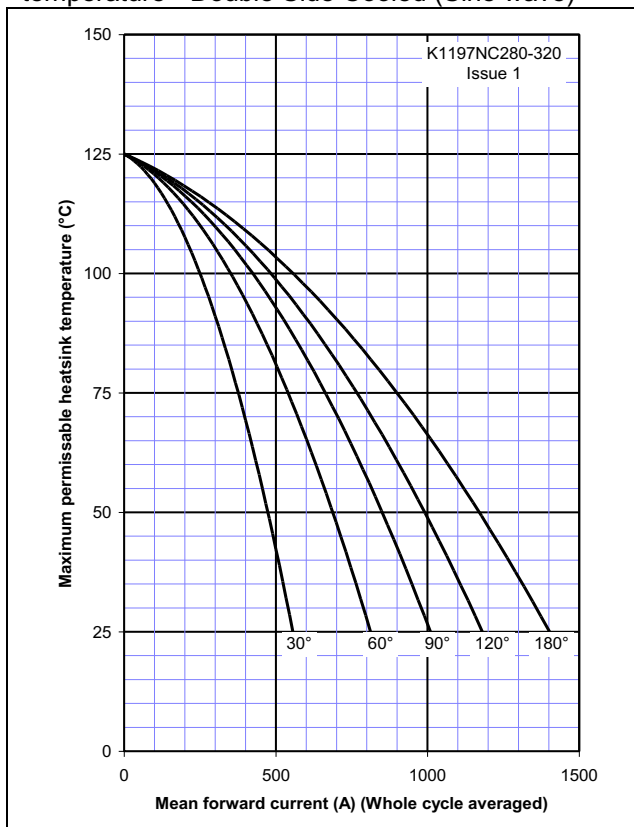

Figure 11 – On-state current vs. Power dissipation – Double Side Cooled (Square wave)

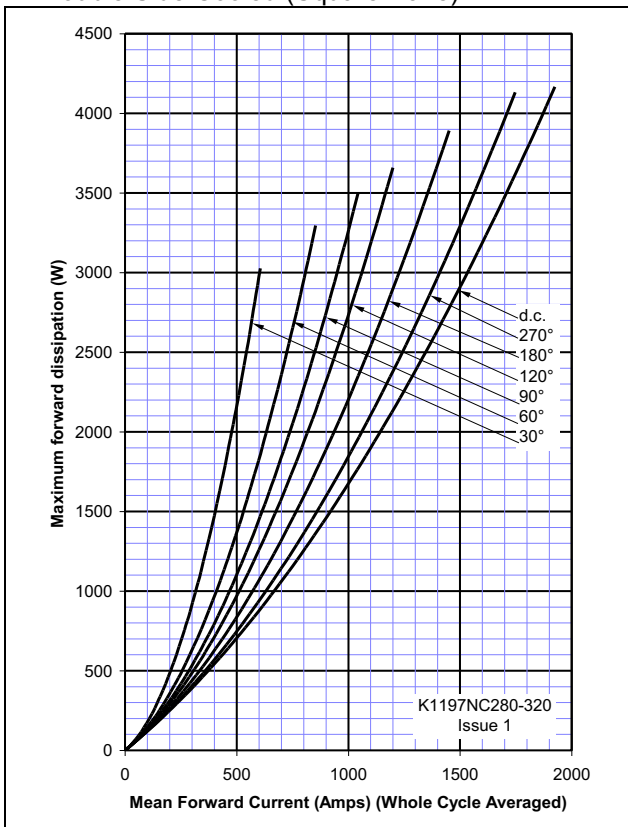

Figure 12 – On-state current vs. Heatsink temperature – Double Side Cooled (Square wave)

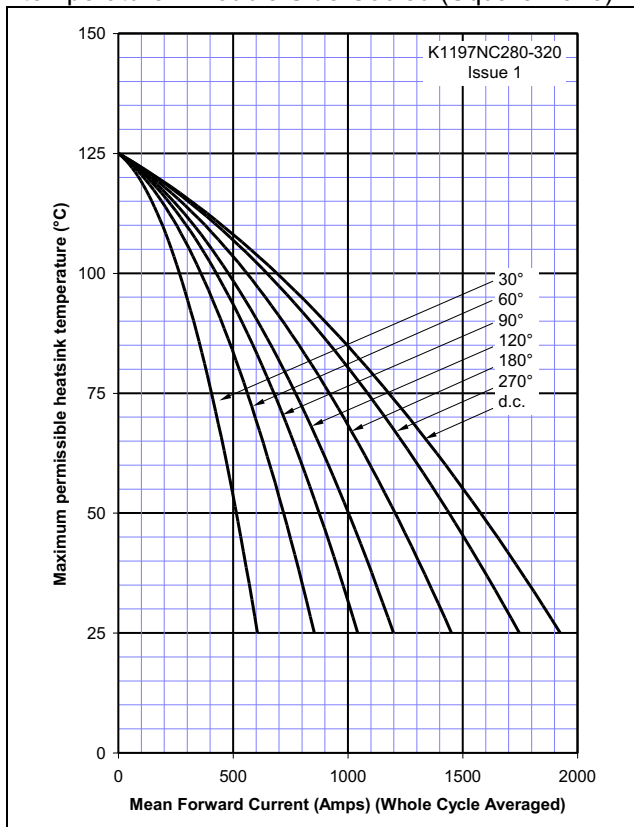

Figure 13 – On-state current vs. Power dissipation – Single Side Cooled (Sine wave)

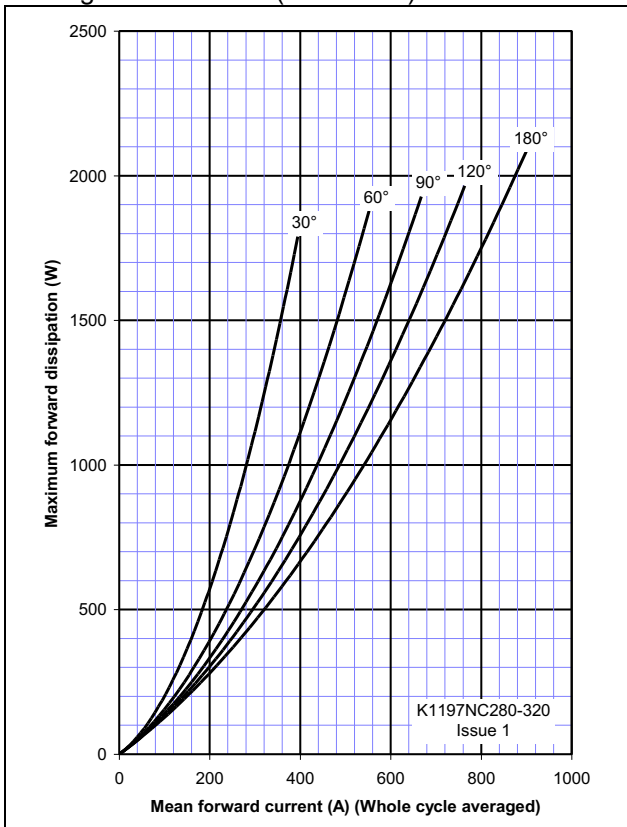

Figure 14 – On-state current vs. Heatsink temperature – Single Side Cooled (Sine wave)

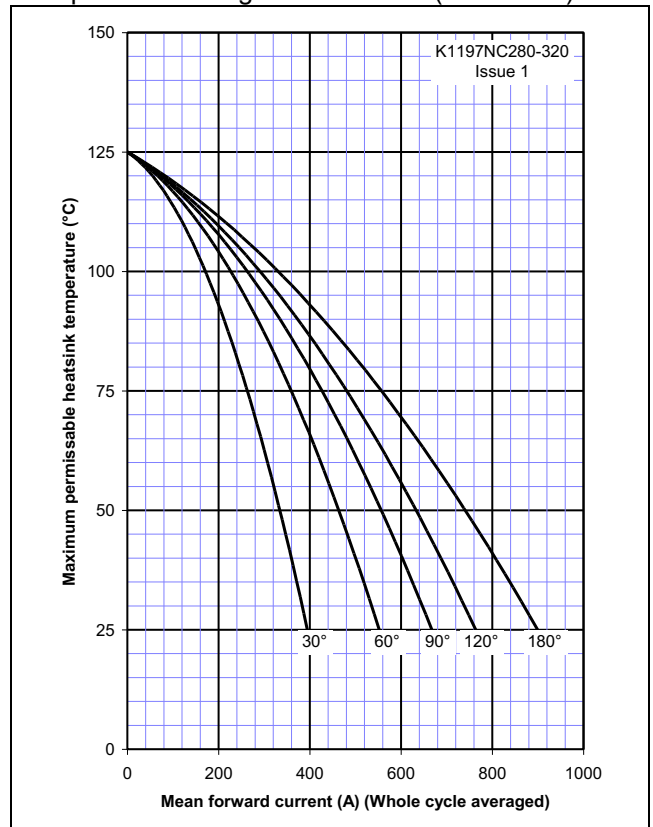

Figure 15 – On-state current vs. Power dissipation – Single Side Cooled (Square wave)

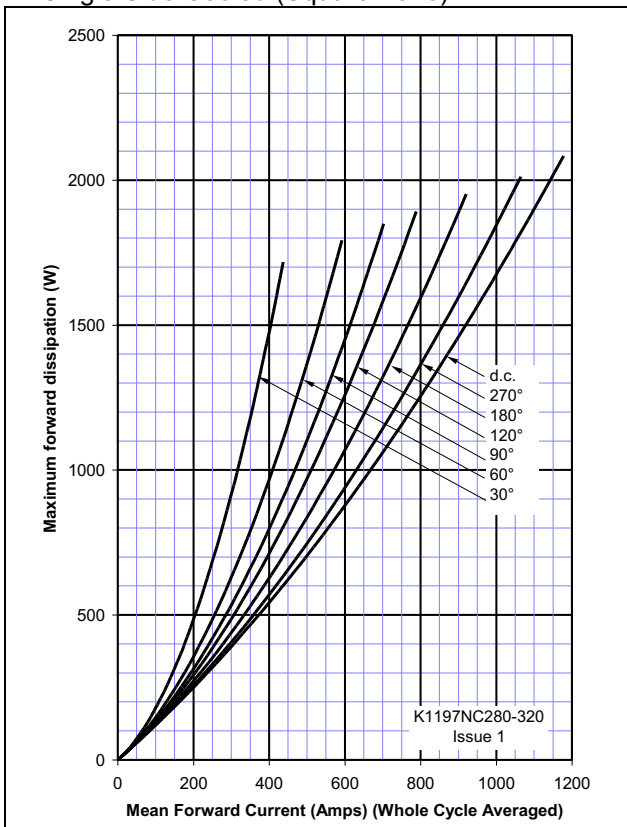

Figure 16 – On-state current vs. Heatsink temperature – Single Side Cooled (Square wave)

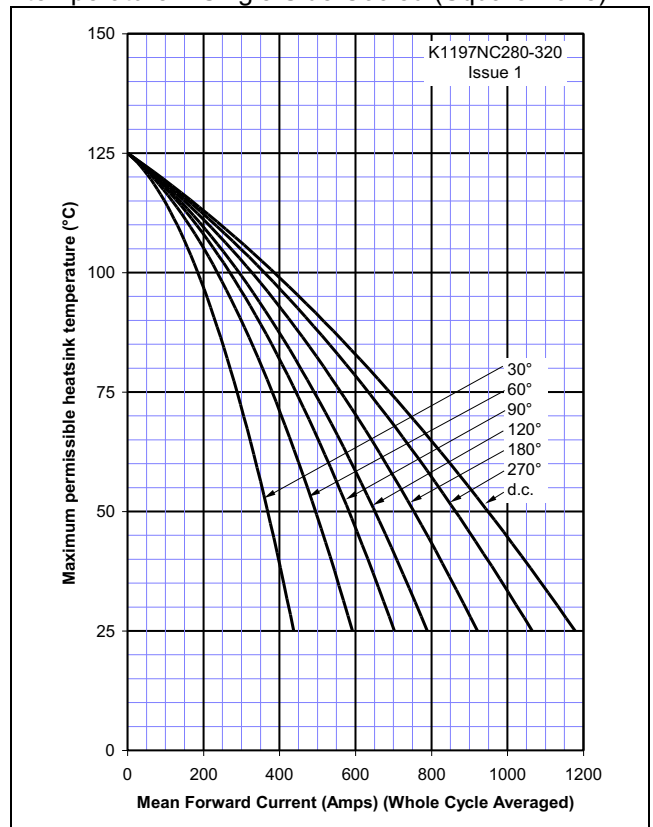

Figure 17 – Square Wave Frequency Ratings

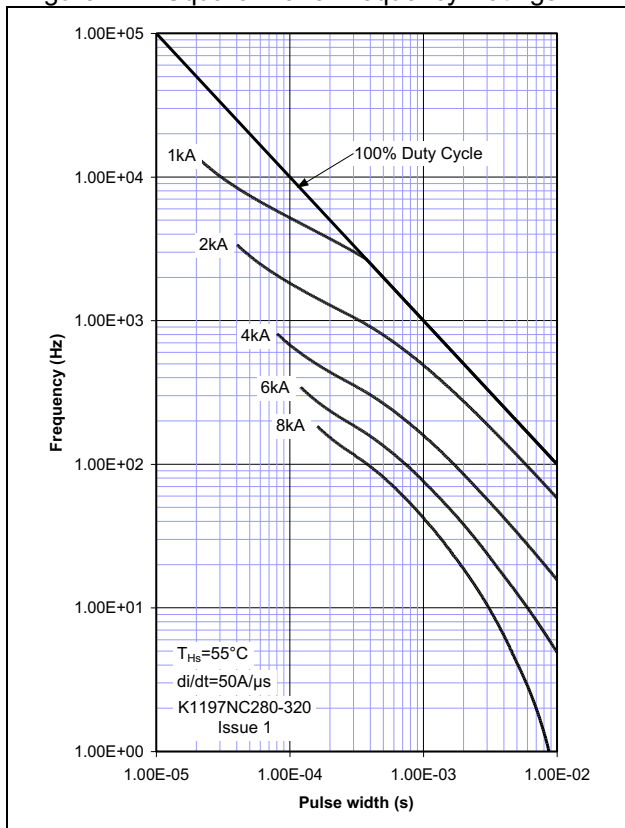

Figure 18 – Sine Wave Frequency Ratings

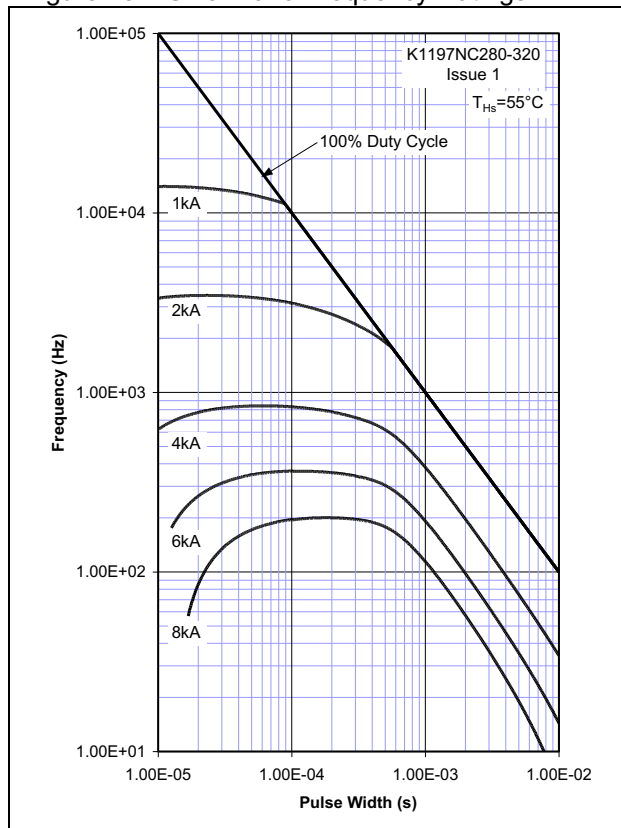
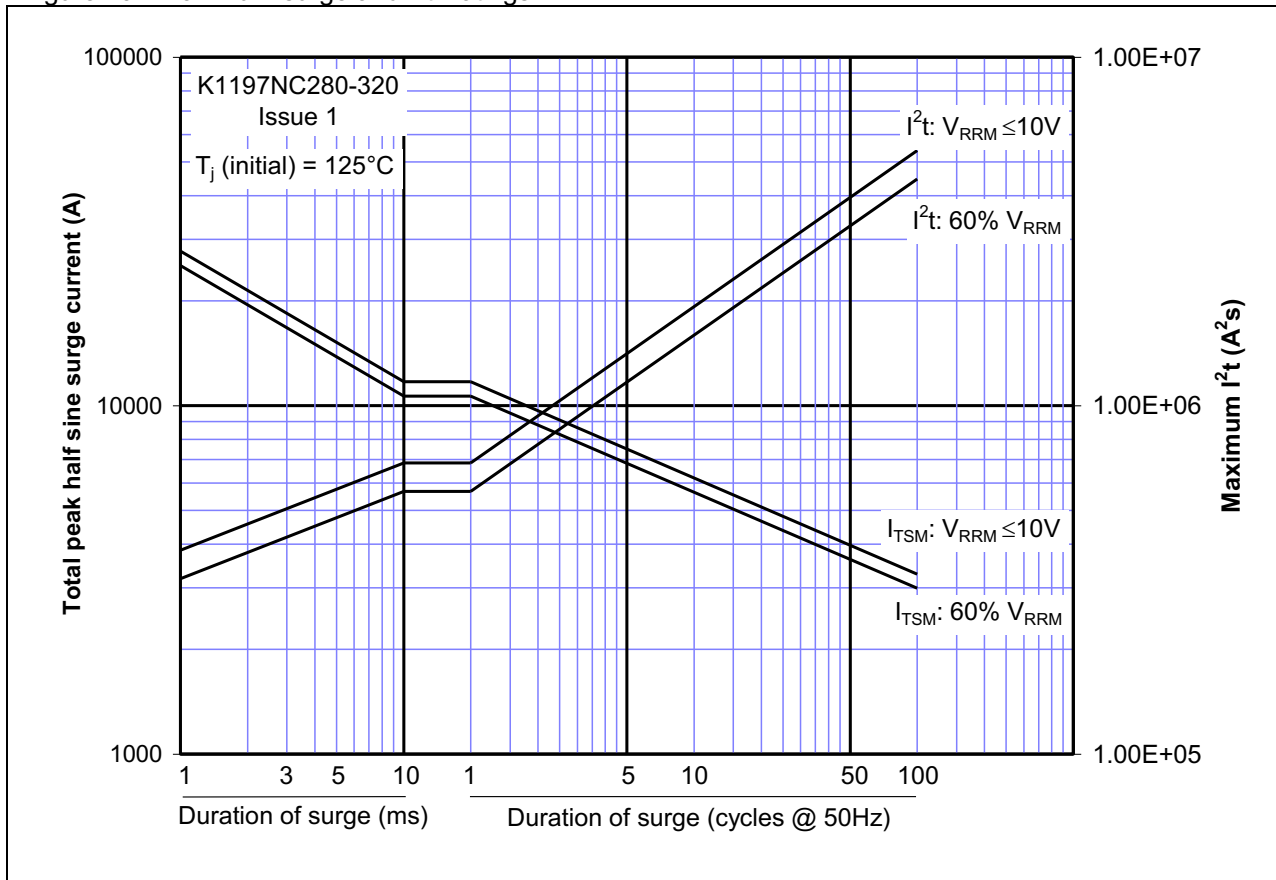
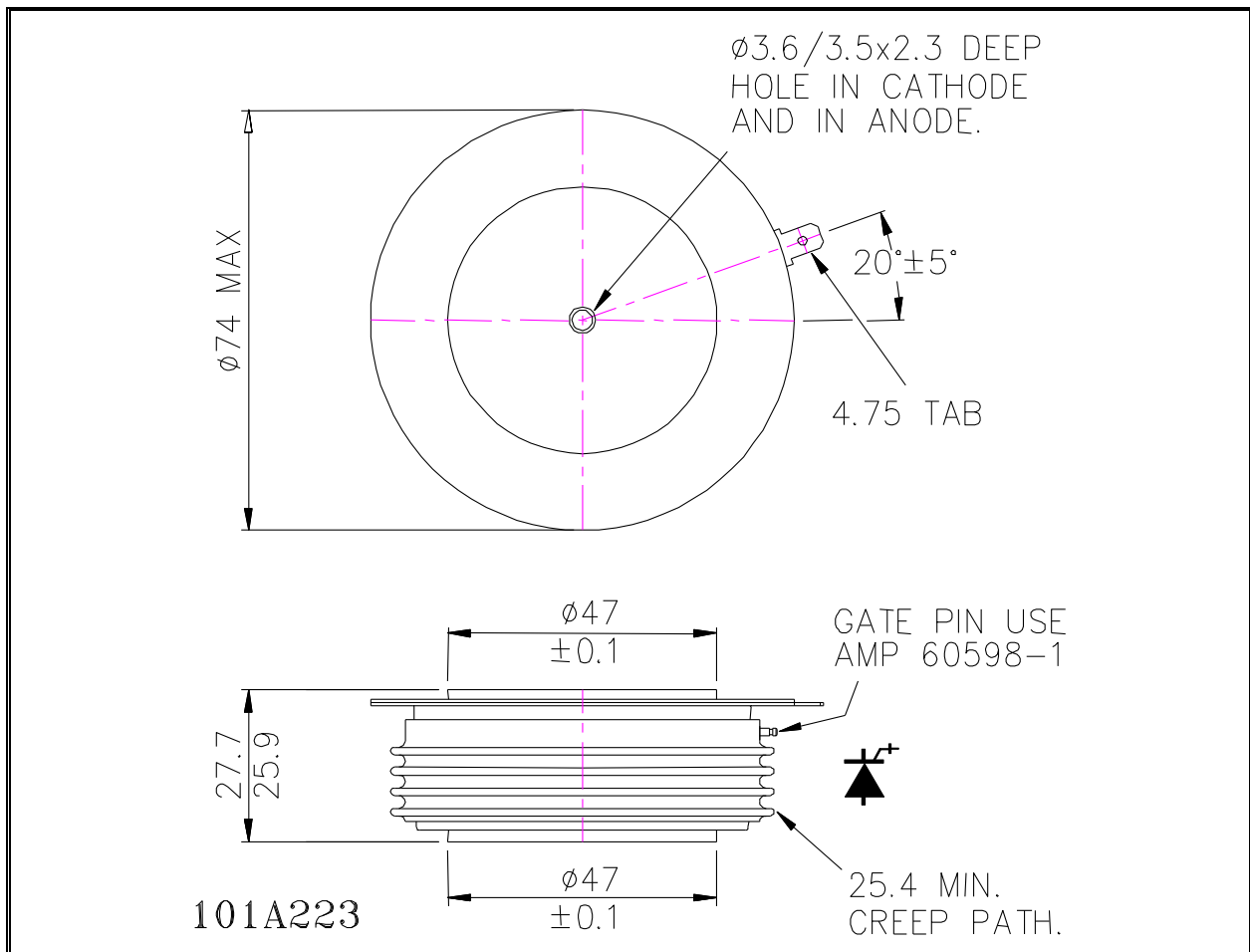

Figure 19 - Maximum surge and I^2t Ratings



Outline Drawing & Ordering Information



ORDERING INFORMATION			
(Please quote 10 digit code as below)			
K1197	NC	◆◆	0
Fixed Type Code	Fixed outline code	Voltage code $V_{DRM}/100$ 28-32	Fixed turn-off time code

Order code: K1197NC300 – 3000V V_{RRM} , 27.7mm clamp height capsule.

IXYS Semiconductor GmbH
Edisonstraße 15
D-68623 Lampertheim
Tel: +49 6206 503-0
Fax: +49 6206 503-627
E-mail: marcom@ixys.de

WESTCODE
An IXYS Company

Westcode Semiconductors Ltd
PO Box 57 Chippenham
Wiltshire SN15 1JL
Tel: +44 (0)1249 444524
Fax: +44 (0)1249 659448
E-mail: WSL.sales@westcode.com

IXYS Corporation
3540 Bassett Street
Santa Clara CA 95054 USA
Tel: +1 (408) 982 0700
Fax: +1 (408) 496 0670
E-mail: sales@ixys.net

www.westcode.com

www.ixys.net

Westcode Semiconductors Inc
3270 Cherry Avenue
Long Beach CA 90807 USA
Tel: +1 (562) 595 6971
Fax: +1 (562) 595 8182
E-mail: WSI.sales@westcode.com

The information contained herein is confidential and is protected by Copyright. The information may not be used or disclosed except with the written permission of and in the manner permitted by the proprietors Westcode Semiconductors Ltd.

© Westcode Semiconductors Ltd.

In the interest of product improvement, Westcode reserves the right to change specifications at any time without prior notice.

Devices with a suffix code (2-letter or letter/digit/letter combination) added to their generic code are not necessarily subject to the conditions and limits contained in this report.



Disclaimer Notice - Information furnished is believed to be accurate and reliable. However, users should independently evaluate the suitability of and test each product selected for their own applications. Littelfuse products are not designed for, and may not be used in, all applications. Read complete Disclaimer Notice at www.littelfuse.com/disclaimer-electronics.