



Anode Shorted Gate Turn-Off Thyristor Types G4000EF250

Absolute Maximum Ratings

	VOLTAGE RATINGS	MAXIMUM LIMITS	UNITS
V _{DRM}	Repetitive peak off-state voltage, (note 1)	2500	V
V _{RSM}	Non-repetitive peak off-state voltage, (note 1)	2500	V
V _{DC-link}	Maximum continuous DC-link voltage	1250	V
V _{RRM}	Repetitive peak reverse voltage	18	V
V _{RSM}	Non-repetitive peak reverse voltage	18	V

	RATINGS	MAXIMUM LIMITS	UNITS
I _{TGQ}	Peak turn-off current, (note 2)	4000	A
L _s	Snubber loop inductance, I _{TM} =I _{TGQ} , (note 2)	200	nH
I _{T(AV)M}	Mean on-state current, T _{sink} =55°C (note 3)	1835	A
I _{T(RMS)}	Nominal RMS on-state current, 25°C (note 3)	3815	A
I _{TSM}	Peak non-repetitive surge current t _p =10ms, (Note 4)	33	kA
I _{TSM2}	Peak non-repetitive surge current t _p =2ms, (Note 4)	41	kA
I ² t	I ² t capacity for fusing t _p =10ms	5.45×10 ⁶	A ² s
di/dt _{cr}	Critical rate of rise of on-state current, (note 5)	500	A/μs
P _{FGM}	Peak forward gate power	200	W
P _{RGM}	Peak reverse gate power	25	kW
I _{FGM}	Peak forward gate current	100	A
V _{RGM}	Peak reverse gate voltage (note 6).	18	V
T _{j op}	Operating temperature range	-40 to +125	°C
T _{stg}	Storage temperature range	-40 to +125	°C

Notes:-

- 1) V_{GK}=-2Volts.
- 2) T_j=125°C, V_D=1250V, V_{DM}≤2500V di_{GQ}/dt=40A/μs, I_{TGQ}=4000A and C_S=6μF.
- 3) Double-side cooled, single phase; 50Hz, 180° half-sinewave.
- 4) T_{j(initial)}=125°C, single phase, 180° sinewave, re-applied voltage V_D=V_R≤10V.
- 5) I_T=4000A repetitive, I_{GM}=50A, di_{GM}/dt=50A/μs. For di/dt>500A/μs please consult the factory.
- 6) May exceed this value during turn-off avalanche period.

Characteristics

	Parameter	MIN	TYP	MAX	TEST CONDITIONS	UNITS
V_{TM}	Maximum peak on-state voltage	-	3.1	3.4	$I_G=8A, I_T=4000A$	V
I_L	Latching current	-	40	100	$T_j=25^\circ C$	A
I_H	Holding current.	-	40	100	$T_j=25^\circ C$	A
dv/dt_{cr}	Critical rate of rise of off-state voltage	1000	-	-	$V_D=3000V, V_{GR}=-2V$	V/ μs
I_{DRM}	Peak off state current	-	-	100	Rated $V_{DRM}, V_{GR}=-2V$	mA
I_{RRM}	Peak reverse current	-	-	10	$V_{RR}=18V$	mA
I_{GKM}	Peak negative gate leakage current	-	-	1	$V_{GR}=-18V$	mA
V_{GT}	Gate trigger voltage	-	1.0	-	$T_j=-40^\circ C$	V
		-	0.8	5	$T_j=25^\circ C \quad V_D=25V, R_L=25m\Omega$	V
		-	0.7	-	$T_j=125^\circ C$	V
I_{GT}	Gate trigger current	-	2.6	10	$T_j=-40^\circ C$	A
		-	1.5	5	$T_j=25^\circ C \quad V_D=25V, R_L=25m\Omega$	A
		0.05	0.65	1.75	$T_j=125^\circ C$	A
t_d	Delay time	-	1.3	2	$V_D=1250V, I_{TGO}=4000A, di_T/dt=400A/\mu s, I_{GM}=50A, di_G/dt=20A/\mu s, C_S=6\mu F, R_S=5\Omega$	μs
t_{gt}	Turn-on time	-	4.25	7		μs
E_{on}	Turn-on energy	-	0.65	2.0		J
t_f	Fall time	-	1.8	-	$V_D=1250V, V_{DM}=80\% V_{DRM}, I_{TGO}=4000A, di_{GQ}/dt=50A/\mu s, V_{GR}=-17V, C_S=6\mu F$	μs
t_s	Storage time	-	24	30		μs
t_{gq}	Turn-off time	-	25	35		μs
I_{GQM}	Peak turn-off gate current	-	1000	-		A
Q_{GQ}	Turn-off gate charge	-	14.5	-		mC
t_{tail}	Tail time	-	6.5	-		μs
E_{off}	Turn-off energy	-	4.8	5.8		J
R_{thJK}	Thermal resistance junction to sink	-	-	0.011	Double side cooled	K/kW
		-	-	0.020	Cathode side cooled	K/kW
		-	-	0.024	Anode side cooled	K/kW
F	Mounting force	36	-	48	(see note 2)	kN
W_t	Weight	-	1.5	-		kg

Notes:-

- 1) Unless otherwise indicated $T_j=125^\circ C$.
- 2) For other clamping forces, consult factory.

Notes on ratings and characteristics.

1. Maximum Ratings.

1.1 Off-state voltage ratings.

Unless otherwise indicated, all off-state voltage ratings are given for gate conditions as diagram 1. It should be noted that V_{DRM} is the repeatable peak voltage, which may be applied to the device and does not relate to a DC operating condition.

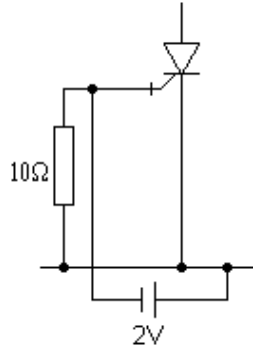

Diagram 1.

1.2 Peak turn-off current.

The figure given in maximum ratings is the highest value for normal operation of the device under conditions given in note 2 of ratings. A snubber circuit equivalent to that given in diagram 2 is assumed. If a more complex snubber, such as an Underland circuit, is employed then the equivalent C_S should be used and $L_S < 0.2\mu H$ must be ensured.

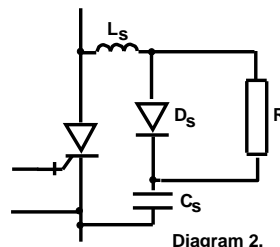

Diagram 2.

1.3 R.M.S and average current.

Measured as for standard thyristor conditions, double side cooled, single phase, 50Hz, 180° half-sinewave. These are included as a guide to compare the alternative types of GTO thyristors available; values cannot be applied to practical applications, as they do not include switching losses.

1.4 Surge rating and I^2t .

Ratings are for half-sinewave, peak value against duration is given in the curve of figure 2.

1.5 Snubber loop inductance.

Use of GTO thyristors with snubber loop inductance, $L_S < 0.2\mu H$ implies no dangerous V_S voltages (see diagrams 2 & 3) can be applied, provided the other conditions given in note 1.2 are enforced. Alternatively V_S should be limited to 800 Volts to avoid possible device failure.

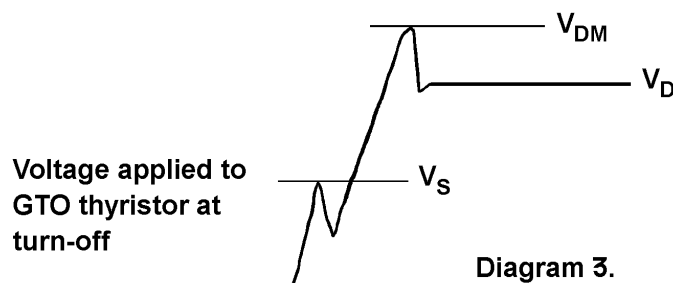

Diagram 3.

1.6 Gate ratings

The absolute conditions above which the gate may be damaged. It is permitted to allow $V_{GK(AV)}$ during turn-off to exceed V_{RGM} which is the implied DC condition.

2 Characteristics

2.1 Instantaneous on-state voltage

Measured using a 500µs square pulse, see also the curves of figure 1 for other values of I_{TM} .

2.2 Latching and holding current

These are considered to be approximately equal and only the latching current is measured, type test only as outlined below. The test circuit and wave diagrams are given in diagram 4. The anode current is monitored on an oscilloscope while V_D is increased, until the current is seen to flow during the un-gated period between the end of I_G and the application of reverse gate voltage. Test frequency is 100Hz with I_{GM} & I_G as for t_d of characteristic data.

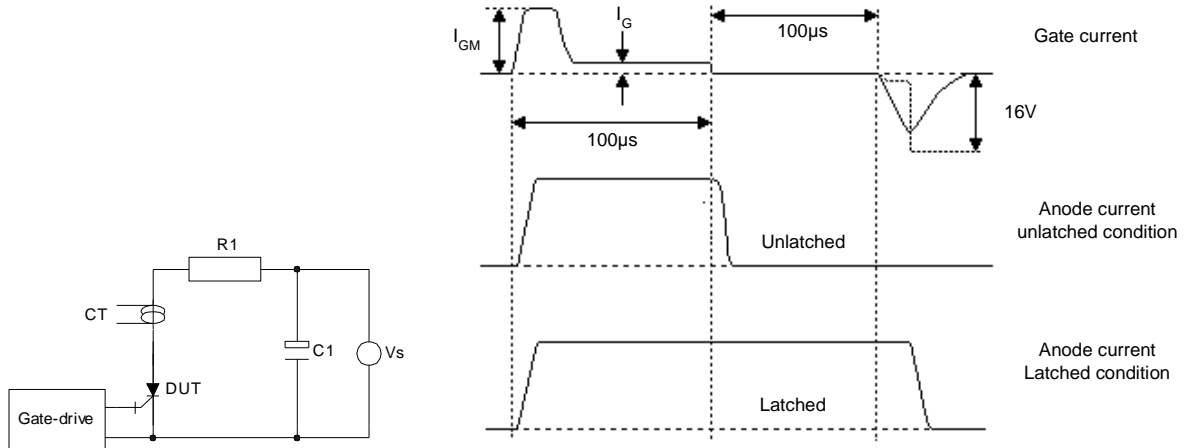

Diagram 4, Latching test circuit and waveforms.

2.3 Critical dv/dt

The gate conditions are the same as for 1.1, this characteristic is for off-state only and does not relate to dv/dt at turn-off. The measurement, type test only, is conducted using the exponential ramp method as shown in diagram 5. It should be noted that GTO thyristors have a poor static dv/dt capability if the gate is open circuit or R_{GK} is high impedance. Typical values: - dv/dt < 100V/µs for $R_{GK} > 10\Omega$.

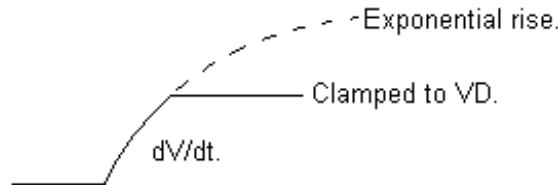

Diagram 5, Definition of dv/dt.

2.4 Off-state leakage.

For I_{DRM} see notes 1.1. For gate leakage I_{GK} , the off-state gate circuit is required to sink this leakage and still maintain minimum of - 2 Volts. See diagram 6.

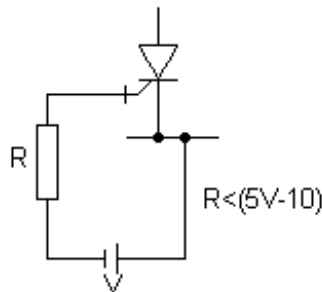

Diagram 6.

2.5 Gate trigger characteristics.

These are measured by slowly ramping up the gate current and monitoring the transition of anode current and voltage (see diagram 7). Maximum and typical data of gate trigger current, for the full junction temperature range, is given in the curves of figure 6. Only typical figures are given for gate trigger voltage for the full allowable junction temperature range. Figure 6 should be used when considering forward gate drive circuit requirement. The gate drive requirements should always be calculated for lowest junction temperature start-up condition.

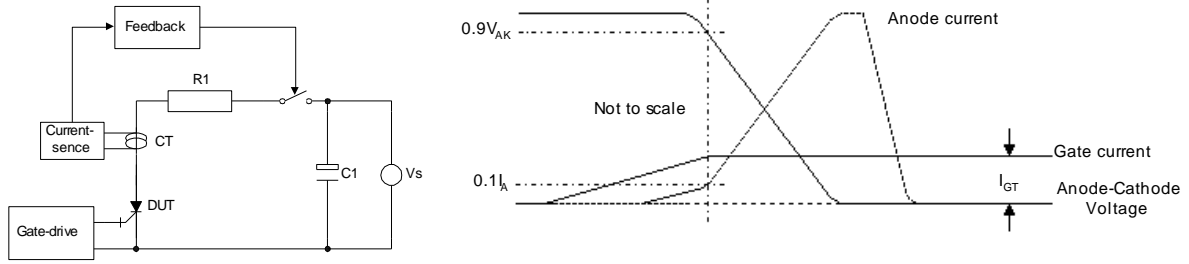

Diagram 7, Gate trigger circuit and waveforms.

2.6 Turn-on characteristics

The definitions of turn-on parameters used in the characteristic data are given in diagram 8.

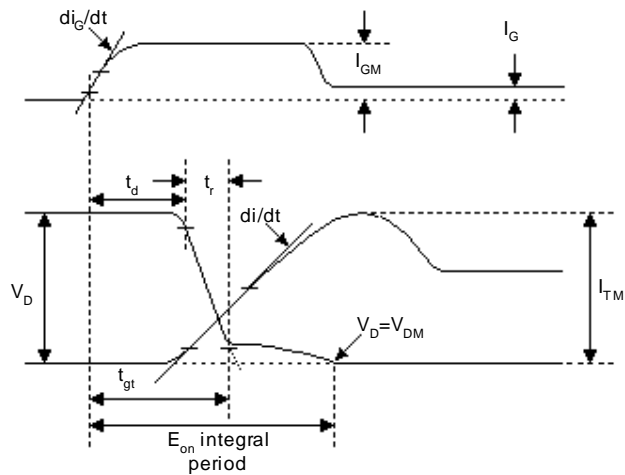

Diagram 8, Turn-on wave-diagrams.

2.7 Turn-off characteristics

The definitions of turn-off parameters used in the characteristic data are given in diagram 9.

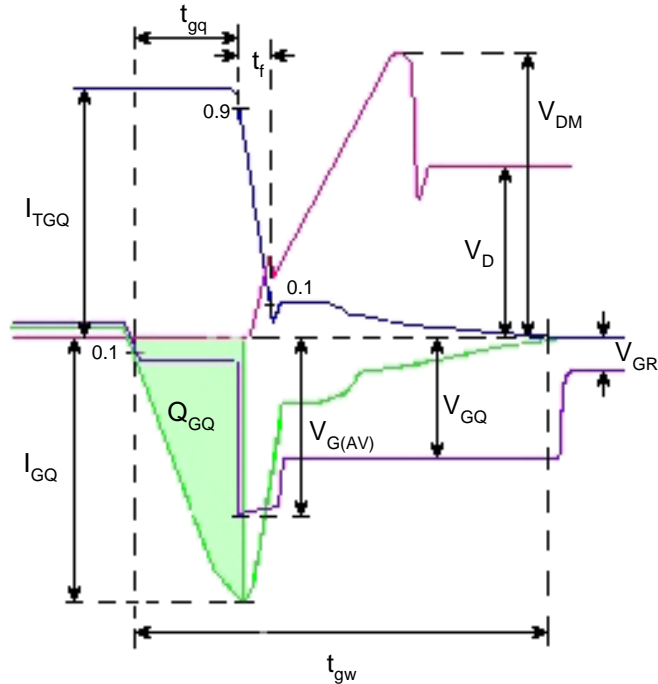

Diagram 9, Turn-off parameter definitions.

Curves

Figure 1 - On-state characteristics of Limit device

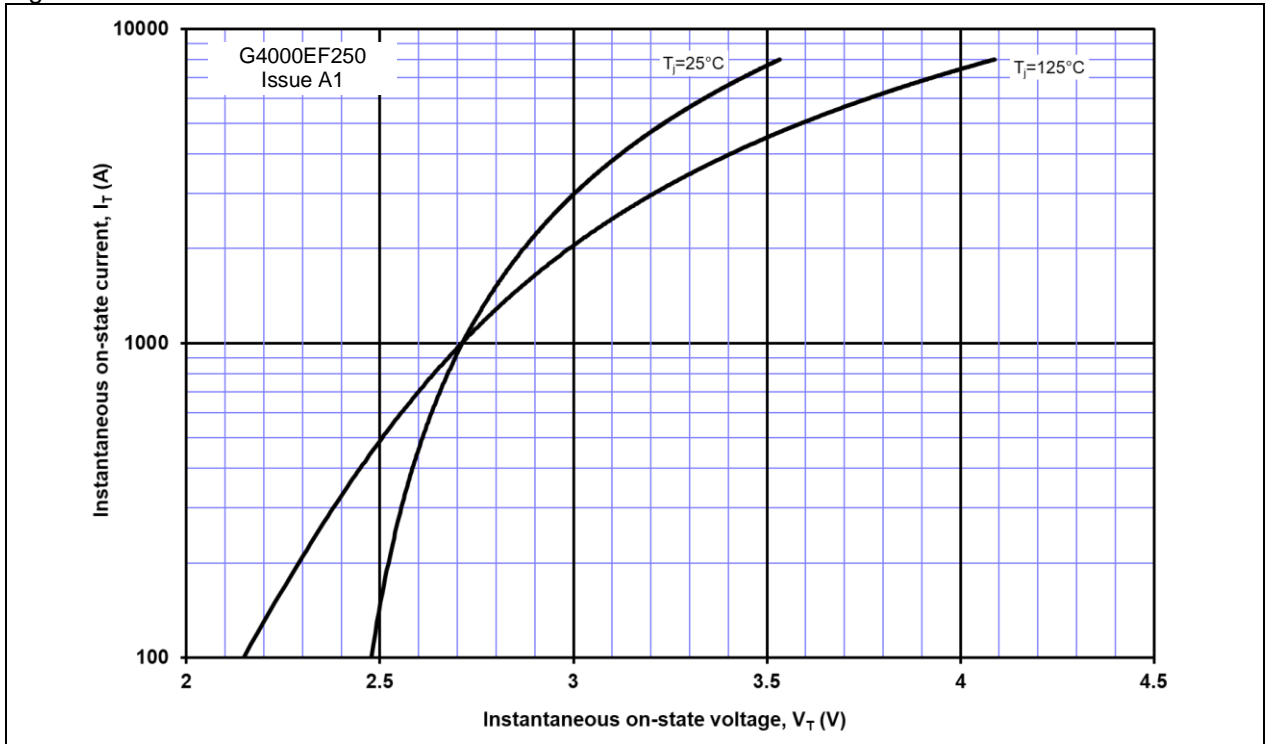

Figure 2 - Maximum surge and I^2t Ratings

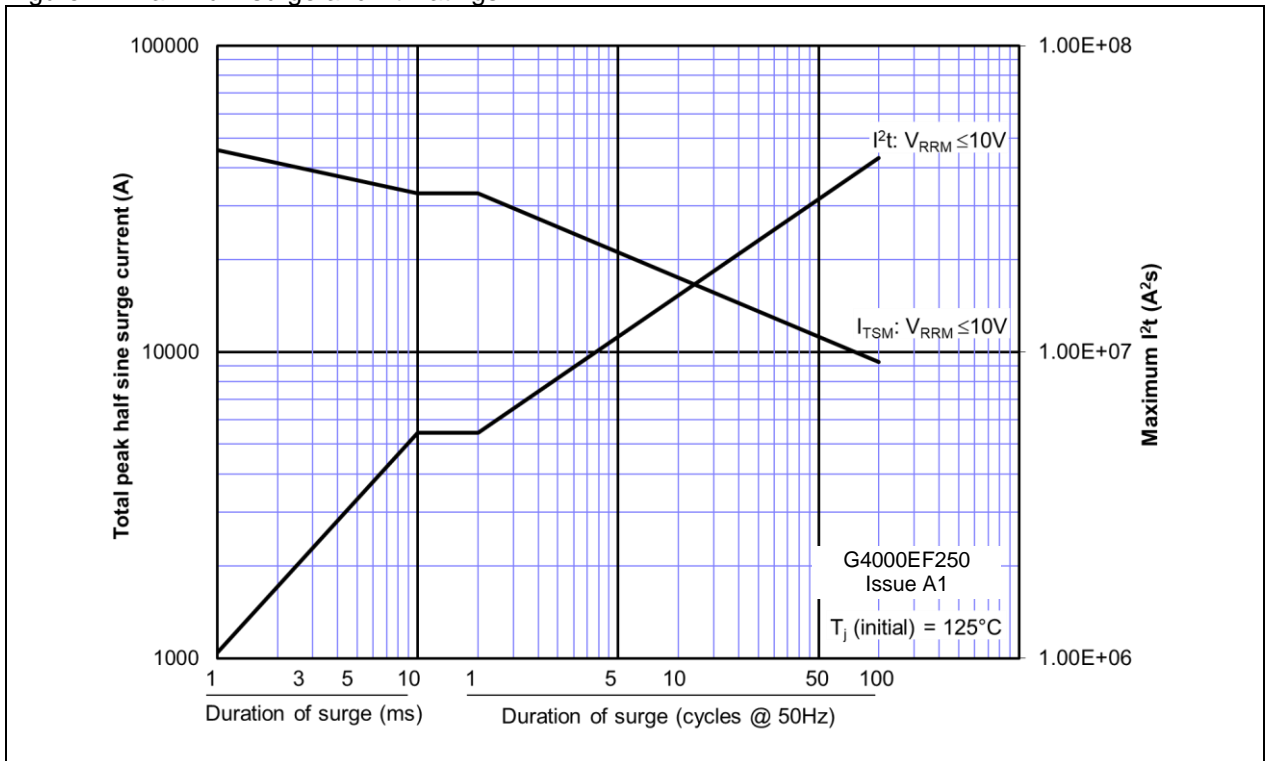

Figure 3 – Instantaneous forward gate characteristics

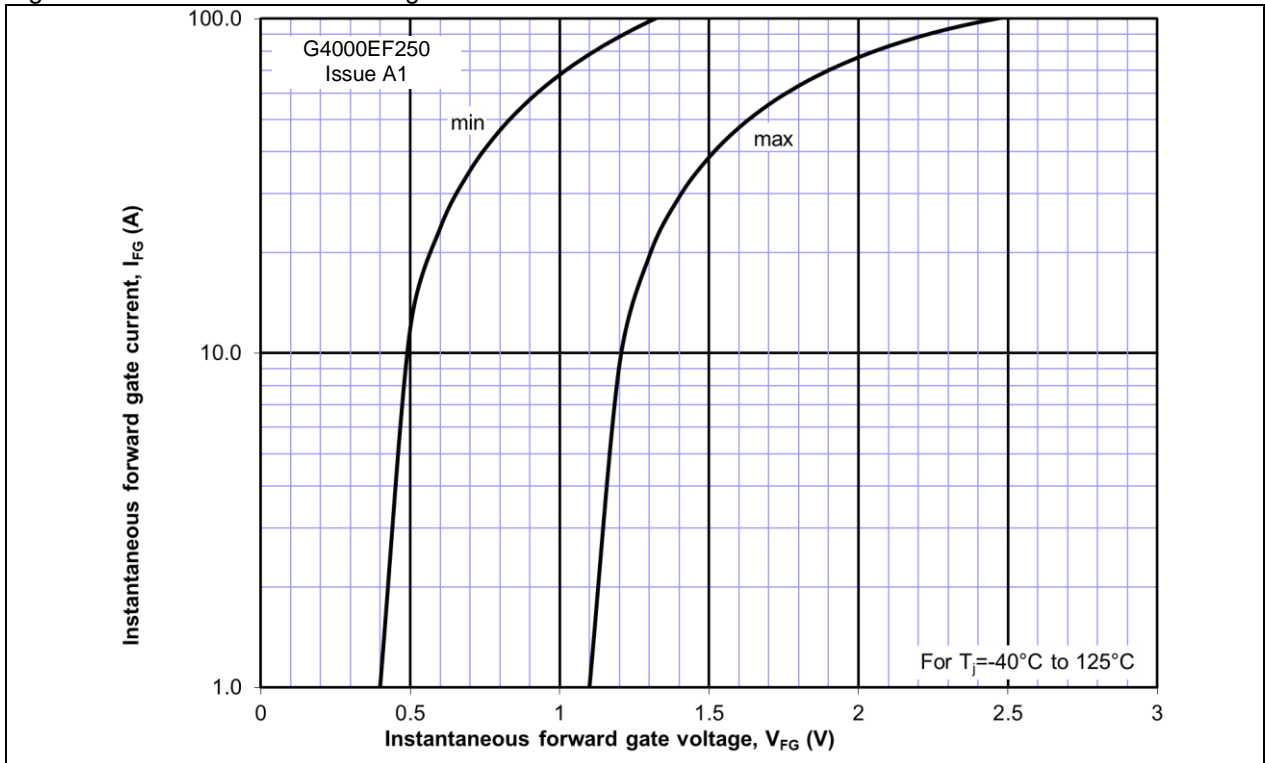

Figure 4 – Transient thermal impedance

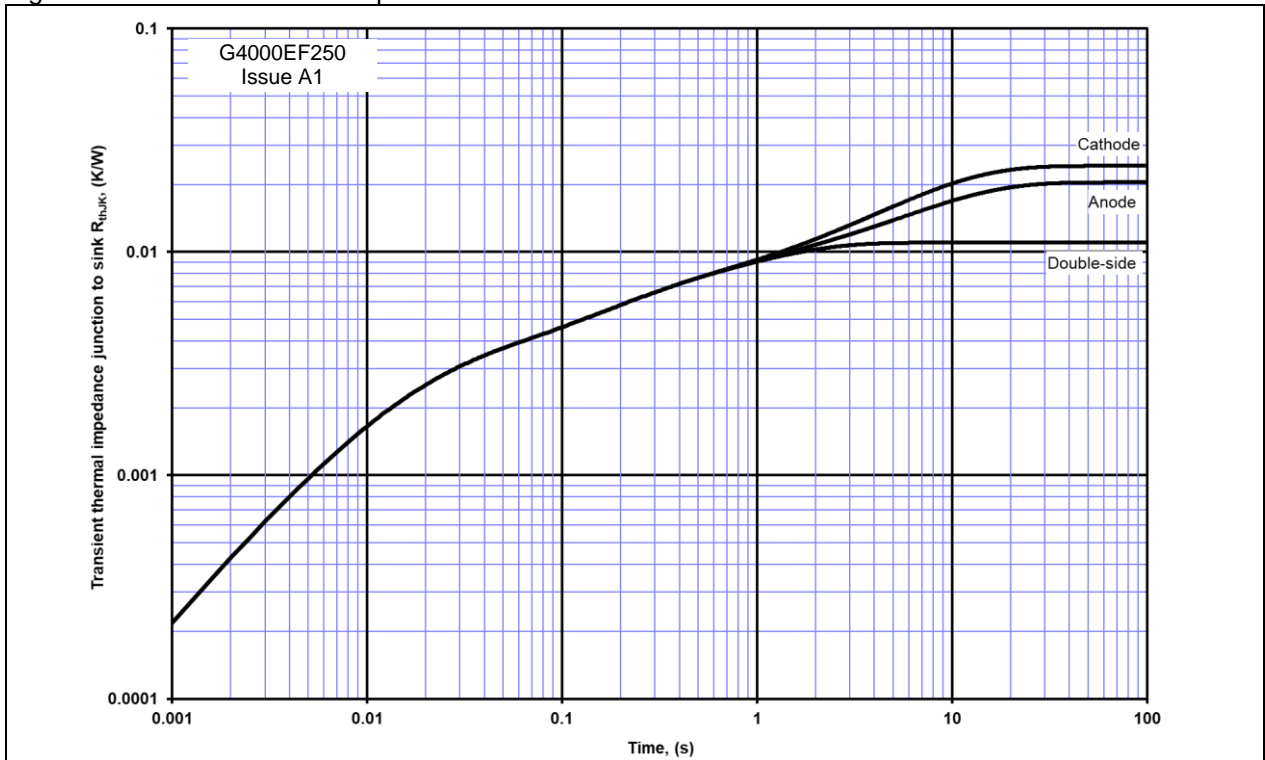

Figure 5 – Typical forward blocking voltage vs. external gate-cathode resistance

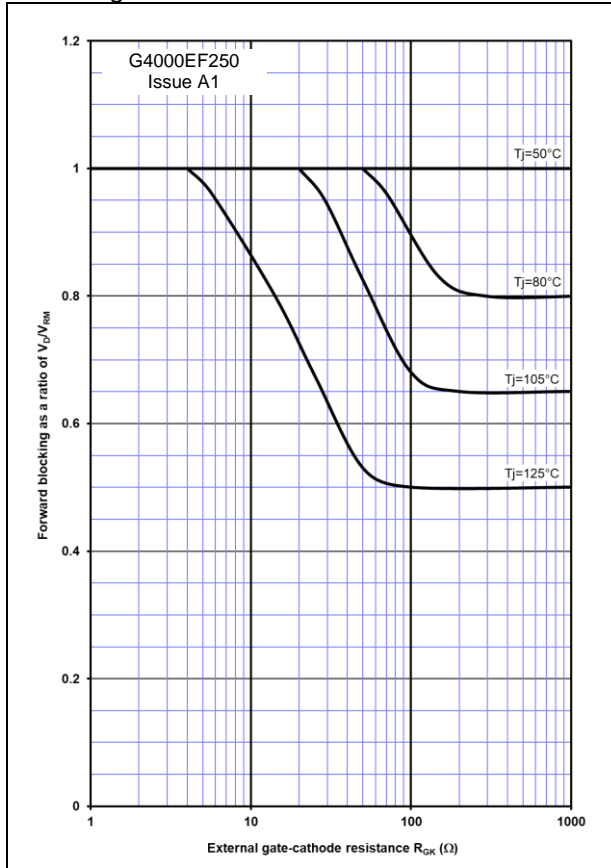

Figure 6 – D.C. gate trigger current vs. junction temperature

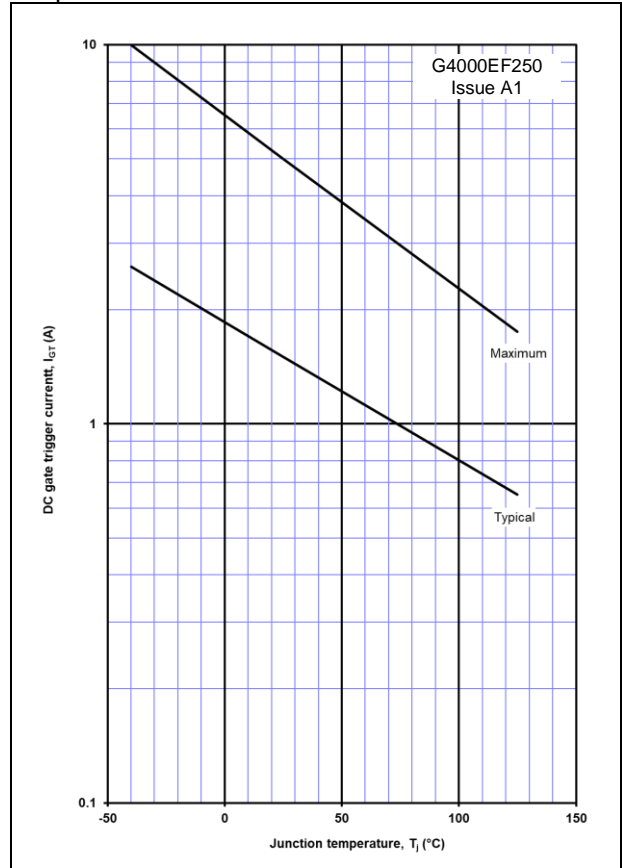

Figure 7 – Typical turn-on energy per pulse vs. turn-on current

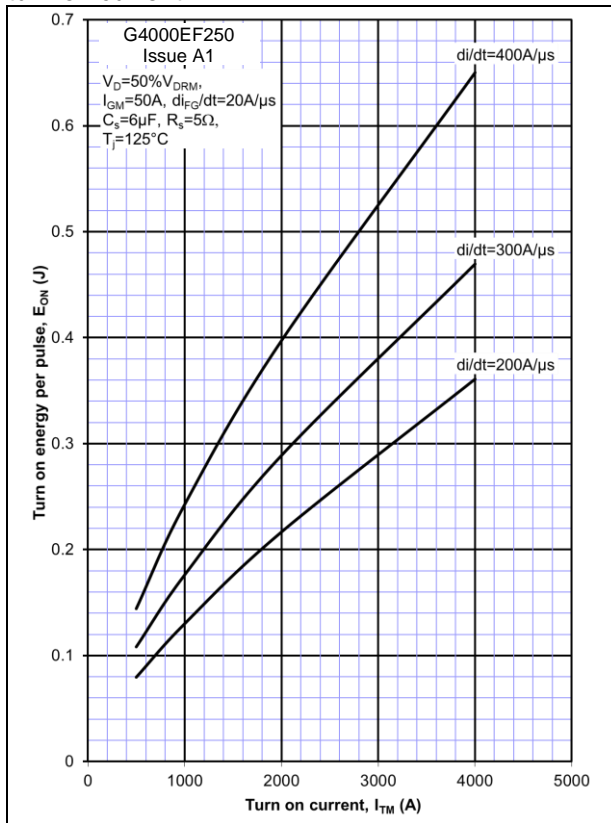

Figure 8 – Typical turn-off energy per pulse vs. turn-off current

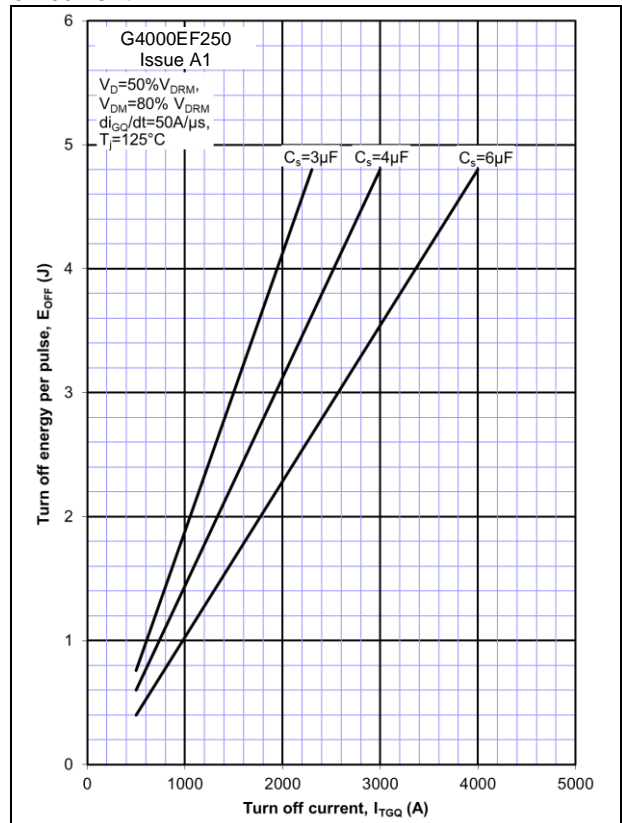

Figure 9 – Typical gate turn-off charge vs. turn-off current

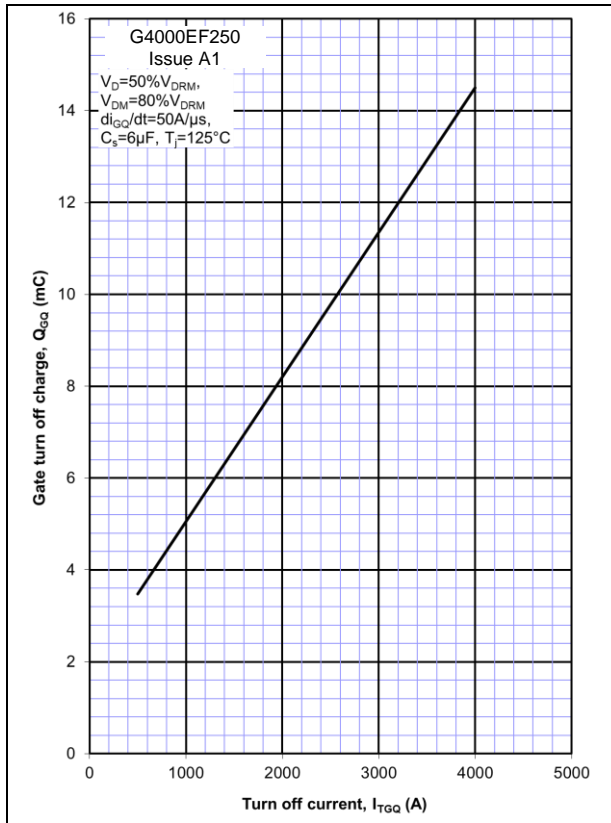
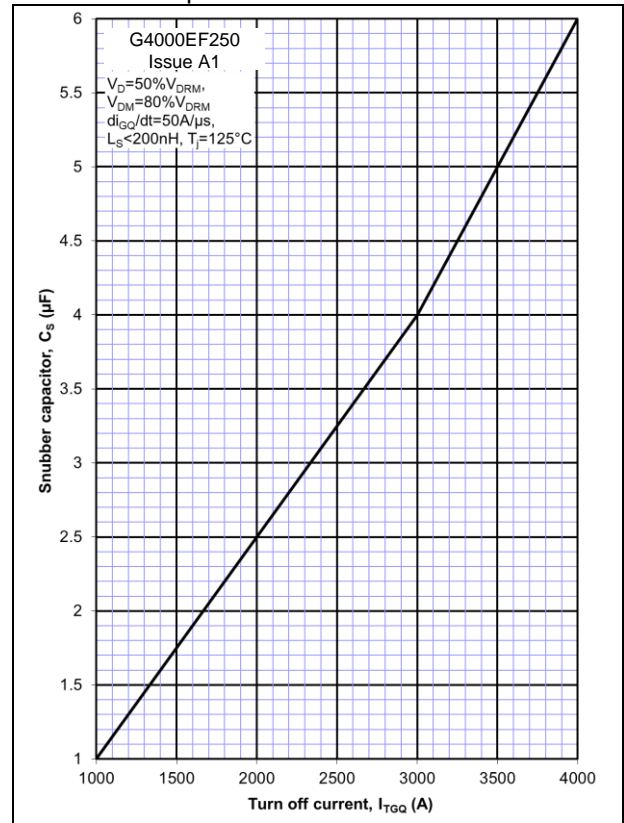
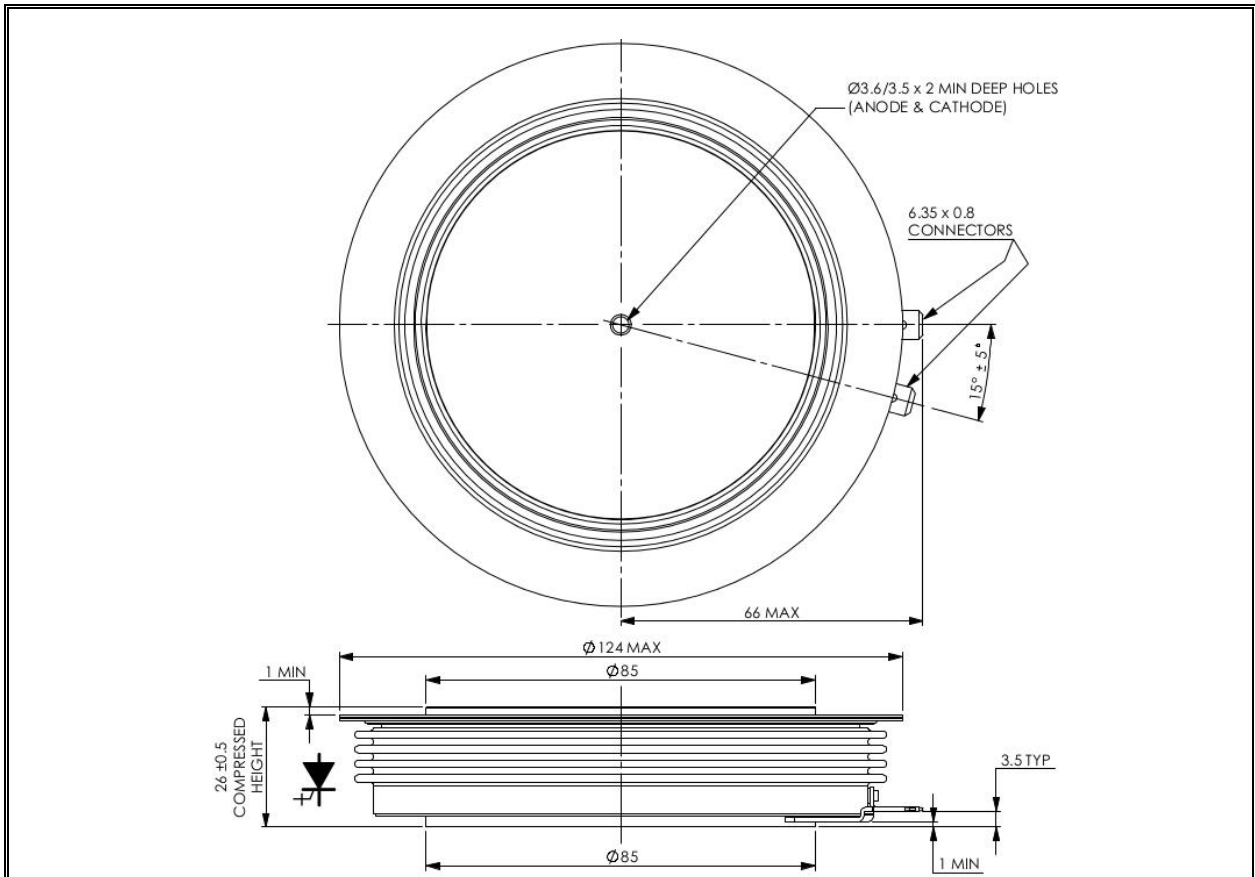

Figure 10 –Maximum permissible turn-off current vs. snubber capacitance



Outline Drawing & Ordering Information



101A408

ORDERING INFORMATION		(Please quote 10 digit code as below)	
G4000	EF	25	0
Fixed Type Code	Fixed Outline Code	Fixed Voltage Code V _{DRM} /100 25	Fixed Code

Order code: G4000EF250

IXYS UK Westcode Ltd
Langley Park Way, Langley Park, Chippenham, Wiltshire, SN15 1GE.
Tel: +44 (0)1249 444524
E-mail: sales@ixysuk.com



IXYS Long Beach
IXYS Long Beach, Inc
2500 Mira Mar Ave, Long Beach CA 90815
Tel: +1 (562) 296 6584
Fax: +1 (562) 296 6585
E-mail: service@ixyslongbeach.com

www.littelfuse.com

www.littelfuse.com/products/power-semiconductors/high-power.aspx

The information contained herein is confidential and is protected by Copyright. The information may not be used or disclosed except with the written permission of and in the manner permitted by the proprietors IXYS UK Westcode Ltd.

© IXYS UK Westcode Ltd.

In the interest of product improvement, IXYS UK Westcode Ltd reserves the right to change specifications at any time without prior notice.

Devices with a suffix code (2-letter or letter/digit/letter combination) added to their generic code are not necessarily subject to the conditions and limits contained in this report.



Disclaimer Notice - Information furnished is believed to be accurate and reliable. However, users should independently evaluate the suitability of and test each product selected for their own applications. Littelfuse products are not designed for, and may not be used in, all applications. Read complete Disclaimer Notice at www.littelfuse.com/disclaimer-electronics.