

# Distributed Gate Thyristor

## Types R1700MC18x & R1700MC21x

### Absolute Maximum Ratings

|                  | VOLTAGE RATINGS                                 | MAXIMUM LIMITS | UNITS |
|------------------|---|----------------|-------|
| V <sub>DRM</sub> | Repetitive peak off-state voltage, (note 1)     | 1800-2100      | V     |
| V <sub>DSM</sub> | Non-repetitive peak off-state voltage, (note 1) | 1800-2100      | V     |
| V <sub>RRM</sub> | Repetitive peak reverse voltage, (note 1)       | 1800           | V     |
| V <sub>RSM</sub> | Non-repetitive peak reverse voltage, (note 1)   | 1900           | V     |

|                       | OTHER RATINGS  | MAXIMUM LIMITS       | UNITS            |
|-----------------------|--|----------------------|------------------|
| I <sub>T(AVM)</sub>   | Maximum average on-state current, T <sub>sink</sub> =55°C, (note 2)  | 1700                 | A                |
| I <sub>T(AVM)</sub>   | Maximum average on-state current. T <sub>sink</sub> =85°C, (note 2)  | 1150                 | A                |
| I <sub>T(AVM)</sub>   | Maximum average on-state current. T <sub>sink</sub> =85°C, (note 3)  | 610                  | A                |
| I <sub>T(RMS)</sub>   | Nominal RMS on-state current, T <sub>sink</sub> =25°C, (note 2)  | 3500                 | A                |
| I <sub>T(d.c.)</sub>  | D.C. on-state current, T <sub>sink</sub> =25°C, (note 4)   | 2875                 | A                |
| I <sub>TSM</sub>      | Peak non-repetitive surge t <sub>p</sub> =10ms, V <sub>rm</sub> =0.6V <sub>RRM</sub> , (note 5)            | 20                   | kA               |
| I <sub>TSM2</sub>     | Peak non-repetitive surge t <sub>p</sub> =10ms, V <sub>rm</sub> ≤10V, (note 5)                             | 22                   | kA               |
| I <sup>2</sup> t      | I <sup>2</sup> t capacity for fusing t <sub>p</sub> =10ms, V <sub>rm</sub> =0.6V <sub>RRM</sub> , (note 5) | 2.00×10 <sup>6</sup> | A <sup>2</sup> s |
| I <sup>2</sup> t      | I <sup>2</sup> t capacity for fusing t <sub>p</sub> =10ms, V <sub>rm</sub> ≤10V, (note 5)                  | 2.42×10 <sup>6</sup> | A <sup>2</sup> s |
| (di/dt) <sub>cr</sub> | Critical rate of rise of on-state current (repetitive), (Note 6)   | 1000                 | A/μs             |
|                       | Critical rate of rise of on-state current (non-repetitive), (Note 6)                                       | 1500                 | A/μs             |
|                       | Critical rate of rise of on-state current (continuous), (Note 6)   | 500                  | A/μs             |
| V <sub>RGM</sub>      | Peak reverse gate voltage  | 5                    | V                |
| P <sub>G(AV)</sub>    | Mean forward gate power  | 5                    | W                |
| P <sub>GM</sub>       | Peak forward gate power  | 30                   | W                |
| T <sub>j op</sub>     | Operating temperature range  | -40 to +125          | °C               |
| T <sub>stg</sub>      | Storage temperature range  | -40 to +150          | °C               |

Notes:-

- 1) De-rating factor of 0.13% per °C is applicable for T<sub>j</sub> below 25°C.
- 2) Double side cooled, single phase; 50Hz, 180° half-sinewave.
- 3) Cathode side cooled, single phase; 50Hz, 180° half-sinewave.
- 4) Double side cooled.
- 5) Half-sinewave, 125°C T<sub>j</sub> initial.
- 6) V<sub>D</sub>=67% V<sub>DRM</sub>, I<sub>FG</sub>=2A, t<sub>r</sub>≤0.5μs, T<sub>case</sub>=125°C.

## Characteristics

|                       | PARAMETER                                  | MIN. | TYP. | MAX.  | TEST CONDITIONS (Note 1)  | UNITS                  |
|-----------------------|--|------|------|-------|---|------------------------|
| V <sub>TM</sub>       | Maximum peak on-state voltage              | -    | -    | 2.10  | I <sub>TM</sub> =1700A  | V                      |
| V <sub>TM</sub>       | Maximum peak on-state voltage              | -    | -    | 2.83  | I <sub>TM</sub> =5100A  | V                      |
| V <sub>T0</sub>       | Threshold voltage                          | -    | -    | 1.60  |   | V                      |
| r <sub>T</sub>        | Slope resistance                           | -    | -    | 0.25  |   | mΩ                     |
| (dv/dt) <sub>cr</sub> | Critical rate of rise of off-state voltage | 200  | -    | -     | V <sub>D</sub> =80% V <sub>DRM</sub> , Linear ramp, Gate o/c  | V/μs                   |
| I <sub>DRM</sub>      | Peak off-state current                     | -    | -    | 100   | Rated V <sub>DRM</sub>  | mA                     |
| I <sub>RRM</sub>      | Peak reverse current                       | -    | -    | 100   | Rated V <sub>RRM</sub>  | mA                     |
| V <sub>GT</sub>       | Gate trigger voltage                       | -    | -    | 3.0   | T <sub>J</sub> =25°C      V <sub>D</sub> =10V, I <sub>T</sub> =3A   | V                      |
| I <sub>GT</sub>       | Gate trigger current                       | -    | -    | 300   |   | mA                     |
| V <sub>GD</sub>       | Gate non-trigger voltage                   | -    | -    | 0.25  |   | Rated V <sub>DRM</sub> |
| I <sub>H</sub>        | Holding current                            | -    | -    | 1000  | T <sub>J</sub> =25°C  | mA                     |
| t <sub>gd</sub>       | Gate controlled turn-on delay time         | -    | 0.5  | 1.0   | V <sub>D</sub> =67% V <sub>DRM</sub> , I <sub>TM</sub> =1000A, di/dt=60A/μs,<br>I <sub>FG</sub> =2A, t <sub>r</sub> =0.5μs, T <sub>J</sub> =25°C          | μs                     |
| t <sub>gt</sub>       | Turn-on time                               | -    | 1.0  | 2.0   |   |                        |
| Q <sub>rr</sub>       | Recovered charge                           | -    | 1100 | 1300  | I <sub>TM</sub> =1000A, t <sub>p</sub> =1000μs, di/dt=60A/μs,<br>V <sub>r</sub> =50V  | μC                     |
| Q <sub>ra</sub>       | Recovered charge, 50% Chord                | -    | 490  | -     |   | μC                     |
| I <sub>rm</sub>       | Reverse recovery current                   | -    | 180  | -     |   | A                      |
| t <sub>rr</sub>       | Reverse recovery time                      | -    | 5.4  | -     |   | μs                     |
| t <sub>q</sub>        | Turn-off time (note 2)                     | -    | 30   | -     | I <sub>TM</sub> =1000A, t <sub>p</sub> =1000μs, di/dt=60A/μs,<br>V <sub>r</sub> =50V, V <sub>dr</sub> =33%V <sub>DRM</sub> , dV <sub>dr</sub> /dt=20V/μs  | μs                     |
|                       |  | -    | 40   | -     | I <sub>TM</sub> =1000A, t <sub>p</sub> =1000μs, di/dt=60A/μs,<br>V <sub>r</sub> =50V, V <sub>dr</sub> =33%V <sub>DRM</sub> , dV <sub>dr</sub> /dt=200V/μs |                        |
| R <sub>thJK</sub>     | Thermal resistance, junction to heatsink   | -    | -    | 0.015 | Double side cooled  | K/W                    |
|                       |  | -    | -    | 0.028 | Anode side cooled   | K/W                    |
|                       |  | -    | -    | 0.033 | Cathode side cooled   | K/W                    |
| F                     | Mounting force                             | 27   | -    | 34    |   | kN                     |
| W <sub>t</sub>        | Weight                                     | -    | 550  | -     |   | g                      |

Notes:-

- 1) Unless otherwise indicated T<sub>J</sub>=125°C.
- 2) The required t<sub>q</sub> (specified with dV<sub>dr</sub>/dt=200V/μs) is represented by an 'x' in the device part number. See ordering information for details of t<sub>q</sub> codes.

## Notes on Ratings and Characteristics

### 1.0 Voltage Grade Table

| Voltage Grade | $V_{DRM}$ $V_{DSM}$ $V_{RRM}$<br>V | $V_{RSM}$<br>V | $V_D$ $V_R$<br>DC V |
|---------------|------------------------------------|----------------|---------------------|
| 18            | 1800                               | 1900           | 1200                |
| 21            | 2100                               | 2200           | 1410                |

### 2.0 Extension of Voltage Grades

This report is applicable to other and higher voltage grades when supply has been agreed by Sales/Production.

### 3.0 Extension of Turn-off Time

This Report is applicable to other  $t_q$ /re-applied  $dv/dt$  combinations when supply has been agreed by Sales/Production.

### 4.0 Repetitive $dv/dt$

Higher  $dv/dt$  selections are available up to 1000V/ $\mu$ s on request.

### 5.0 De-rating Factor

A blocking voltage de-rating factor of 0.13%/ $^{\circ}$ C is applicable to this device for  $T_j$  below 25 $^{\circ}$ C.

### 6.0 Snubber Components

When selecting snubber components, care must be taken not to use excessively large values of snubber capacitor or excessively small values of snubber resistor. Such excessive component values may lead to device damage due to the large resultant values of snubber discharge current. If required, please consult the factory for assistance.

### 7.0 Rate of rise of on-state current

The maximum un-primed rate of rise of on-state current must not exceed 1500A/ $\mu$ s at any time during turn-on on a non-repetitive basis. For repetitive performance, the on-state rate of rise of current must not exceed 1000A/ $\mu$ s at any time during turn-on. Note that these values of rate of rise of current apply to the total device current including that from any local snubber network.

### 8.0 Gate Drive

The nominal requirement for a typical gate drive is illustrated below. An open circuit voltage of at least 30V is assumed. This gate drive must be applied when using the full  $di/dt$  capability of the device.

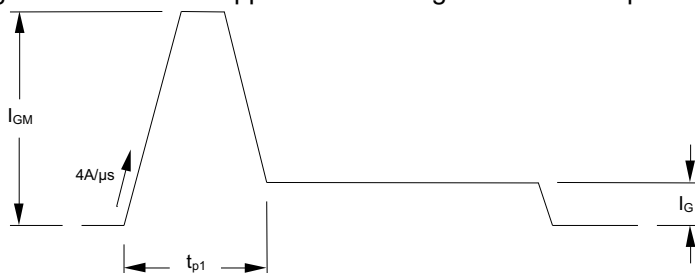

The magnitude of  $I_{GM}$  should be between five and ten times  $I_{GT}$ , which is shown on page 2. Its duration ( $t_{p1}$ ) should be 20 $\mu$ s or sufficient to allow the anode current to reach ten times  $I_L$ , whichever is greater. Otherwise, an increase in pulse current could be needed to supply the necessary charge to trigger. The 'back-porch' current  $I_G$  should remain flowing for the same duration as the anode current and have a magnitude in the order of 1.5 times  $I_{GT}$ .

9.0 Frequency Ratings

The curves illustrated in figures 10 to 18 are for guidance only and are superseded by the maximum ratings shown on page 1.

10.0 Square wave ratings

These ratings are given for load component rate of rise of forward current of 100 and 500 A/μs.

11.0 Duty cycle lines

The 100% duty cycle is represented on all the ratings by a straight line. Other duties can be included as parallel to the first.

12.0 Maximum Operating Frequency

The maximum operating frequency is set by the on-state duty, the time required for the thyristor to turn off ( $t_q$ ) and for the off-state voltage to reach full value ( $t_v$ ), i.e.

$$f_{\max} = \frac{1}{t_{\text{pulse}} + t_q + t_v}$$

13.0 On-State Energy per Pulse Characteristics

These curves enable rapid estimation of device dissipation to be obtained for conditions not covered by the frequency ratings.

Let  $E_p$  be the Energy per pulse for a given current and pulse width, in joules  
 Let  $R_{th(J-Hs)}$  be the steady-state d.c. thermal resistance (junction to sink)  
 and  $T_{SINK}$  be the heat sink temperature.

Then the average dissipation will be:

$$W_{AV} = E_p \cdot f \text{ and } T_{SINK(\max.)} = 125 - (W_{AV} \cdot R_{th(J-Hs)})$$

14.0 Reverse recovery ratings

(i)  $Q_{ra}$  is based on 50%  $I_{RM}$  chord as shown in Fig. 1

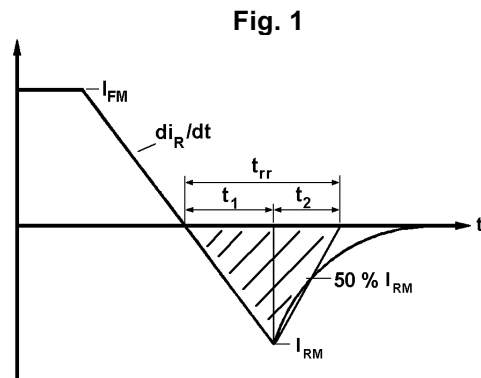

**Fig. 1**

(ii)  $Q_{rr}$  is based on a 50μs integration time i.e.

$$Q_{rr} = \int_0^{150\mu s} i_{rr} \cdot dt$$

(iii)

$$K \text{ Factor} = \frac{t1}{t2}$$

## 15.0 Reverse Recovery Loss

### 15.1 Determination by Measurement

From waveforms of recovery current obtained from a high frequency shunt (see Note 1, Page 5) and reverse voltage present during recovery, an instantaneous reverse recovery loss waveform must be constructed. Let the area under this waveform be E joules per pulse. A new heat sink temperature can then be evaluated from the following:

$$T_{SINK(new)} = T_{SINK(original)} - E \cdot (k + f \cdot R_{th(J-Hs)})$$

Where  $k=0.227$  ( $^{\circ}\text{C}/\text{W}/\text{s}$ )

E = Area under reverse loss waveform per pulse in joules (W.s.)

f = rated frequency Hz at the original heat sink temperature.

$R_{th(J-Hs)}$  = d.c. thermal resistance ( $^{\circ}\text{C}/\text{W}$ ).

The total dissipation is now given by:

$$W_{(TOT)} = W_{(original)} + E \cdot f$$

### 15.2 Determination without Measurement

In circumstances where it is not possible to measure voltage and current conditions, or for design purposes, the additional losses E in joules may be estimated as follows.

Let E be the value of energy per reverse cycle in joules (curves in Figure 9).

Let f be the operating frequency in Hz

$$T_{SINK(new)} = T_{SINK(original)} - (E \cdot R_{th} \cdot f)$$

Where  $T_{SINK(new)}$  is the required maximum heat sink temperature and

$T_{SINK(original)}$  is the heat sink temperature given with the frequency ratings.

A suitable R-C snubber network is connected across the thyristor to restrict the transient reverse voltage to a peak value ( $V_m$ ) of 67% of the maximum grade. If a different grade is being used or  $V_m$  is other than 67% of Grade, the reverse loss may be approximated by a pro rata adjustment of the maximum value obtained from the curves.

#### **NOTE 1- Reverse Recovery Loss by Measurement**

This thyristor has a low reverse recovered charge and peak reverse recovery current. When measuring the charge, care must be taken to ensure that:

- a.c. coupled devices such as current transformers are not affected by prior passage of high amplitude forward current.
- A suitable, polarised, clipping circuit must be connected to the input of the measuring oscilloscope to avoid overloading the internal amplifiers by the relatively high amplitude forward current signal
- Measurement of reverse recovery waveform should be carried out with an appropriate critically damped snubber, connected across diode anode to cathode. The formula used for the calculation of this snubber is shown below:

$$R^2 = 4 \cdot \frac{V_r}{C_s \cdot di/dt}$$

Where:

|       |   |                            |
|-------|---|----------------------------|
| $V_r$ | = | Commutating source voltage |
| $C_s$ | = | Snubber capacitance        |
| R     | = | Snubber resistance         |

## 16.0 Computer Modelling Parameters

### 16.1 Calculating $V_T$ using ABCD Coefficients

The on-state characteristic  $I_T$  vs  $V_T$ , on page 8 is represented in two ways;

- (i) the well established  $V_{T0}$  and  $r_T$  tangent used for rating purposes and
- (ii) a set of constants A, B, C, D, forming the coefficients of the representative equation for  $V_T$  in terms of  $I_T$  given below:

$$V_T = A + B \cdot \ln(I_T) + C \cdot I_T + D \cdot \sqrt{I_T}$$

The constants, derived by curve fitting software, are given in this report for hot and cold characteristics where possible. The resulting values for  $V_T$  agree with the true device characteristic over a current range, which is limited to that plotted.

|   | 25°C Coefficients | 125°C Coefficients |
|---|-------------------|--------------------|
| A | 2.202998          | 0.5093015          |
| B | 0.1936663         | 0.3626684          |
| C | 0.00022397        | 0.0005274          |
| D | -0.0257965        | -0.0485891         |

## 16.2 D.C. Thermal Impedance Calculation

$$r_t = \sum_{p=1}^{p=n} r_p \cdot \left( 1 - e^{-\frac{t}{\tau_p}} \right)$$

Where  $p = 1$  to  $n$ ,  $n$  is the number of terms in the series.

- $t$  = Duration of heating pulse in seconds.
- $r_t$  = Thermal resistance at time  $t$ .
- $r_p$  = Amplitude of  $p^{\text{th}}$  term.
- $\tau_p$  = Time Constant of  $r_{\text{th}}$  term.

| D.C. Single Side Cooled |                           |                           |                           |                           |                           |
|-------------------------|---------------------------|---------------------------|---------------------------|---------------------------|---------------------------|
| Term                    | 1                         | 2                         | 3                         | 4                         | 5                         |
| $r_p$                   | $9.104123 \times 10^{-3}$ | $3.619725 \times 10^{-3}$ | $7.903528 \times 10^{-4}$ | $1.293186 \times 10^{-3}$ | $1.020409 \times 10^{-4}$ |
| $\tau_p$                | 0.7550773                 | 0.1091817                 | 0.03500190                | $8.477858 \times 10^{-3}$ | $1.163500 \times 10^{-3}$ |

| D.C. Anode Side Cooled |            |                           |                           |                           |
|------------------------|------------|---------------------------|---------------------------|---------------------------|
| Term                   | 1          | 2                         | 3                         | 4                         |
| $r_p$                  | 0.01810857 | $4.157607 \times 10^{-3}$ | $4.191171 \times 10^{-3}$ | $1.205064 \times 10^{-3}$ |
| $\tau_p$               | 4.193879   | 0.4707370                 | 0.08453147                | $5.073650 \times 10^{-3}$ |

| D.C. Cathode Side Cooled |            |                           |                           |                           |
|--------------------------|------------|---------------------------|---------------------------|---------------------------|
| Term                     | 1          | 2                         | 3                         | 4                         |
| $r_p$                    | 0.02445377 | $5.055305 \times 10^{-3}$ | $2.064040 \times 10^{-3}$ | $1.142007 \times 10^{-3}$ |
| $\tau_p$                 | 4.454021   | 0.2250056                 | 0.04386925                | $5.603667 \times 10^{-3}$ |

**Curves**

Figure 1 - On-state characteristics of Limit device

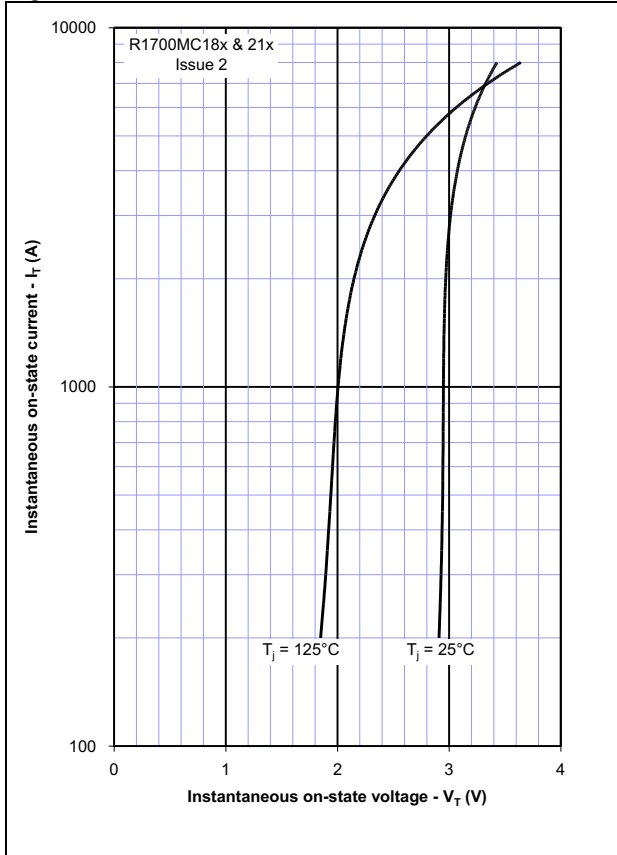

Figure 2 - Transient thermal impedance

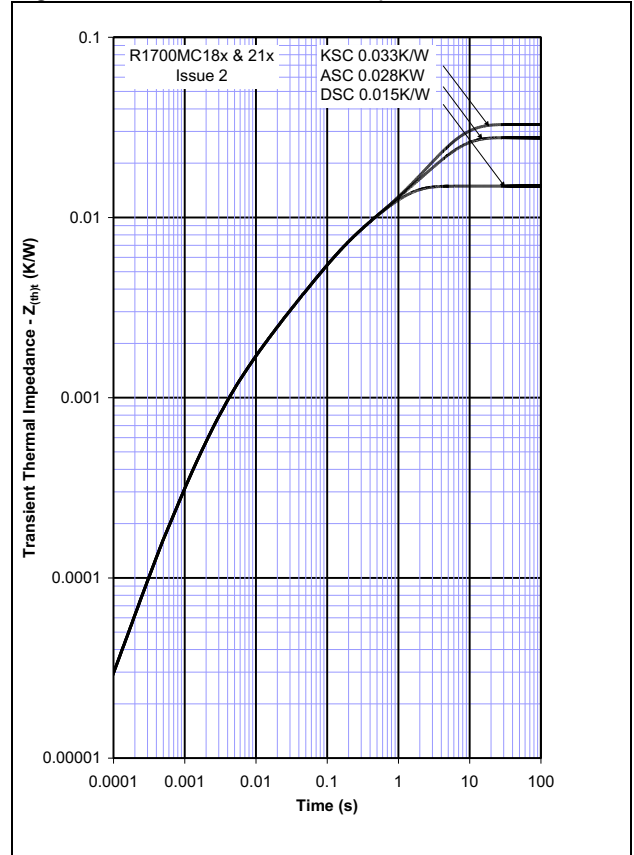

Figure 3 - Gate characteristics - Trigger limits

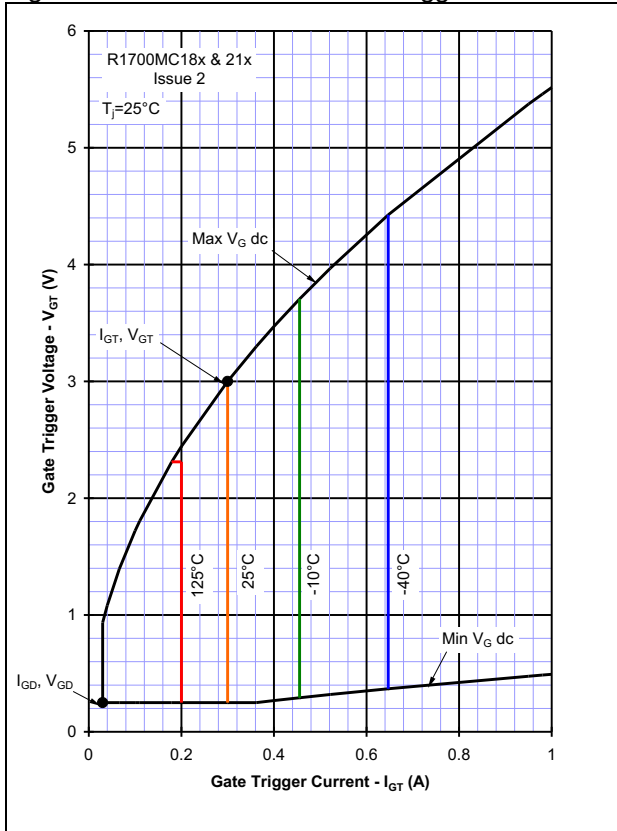

Figure 4 - Gate characteristics - Power curves

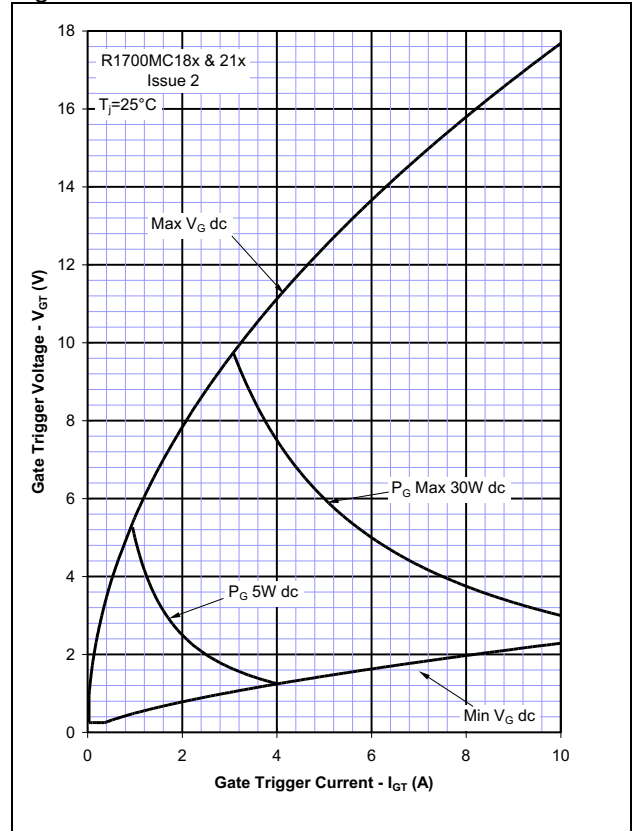



Figure 5 - Total recovered charge,  $Q_{rr}$

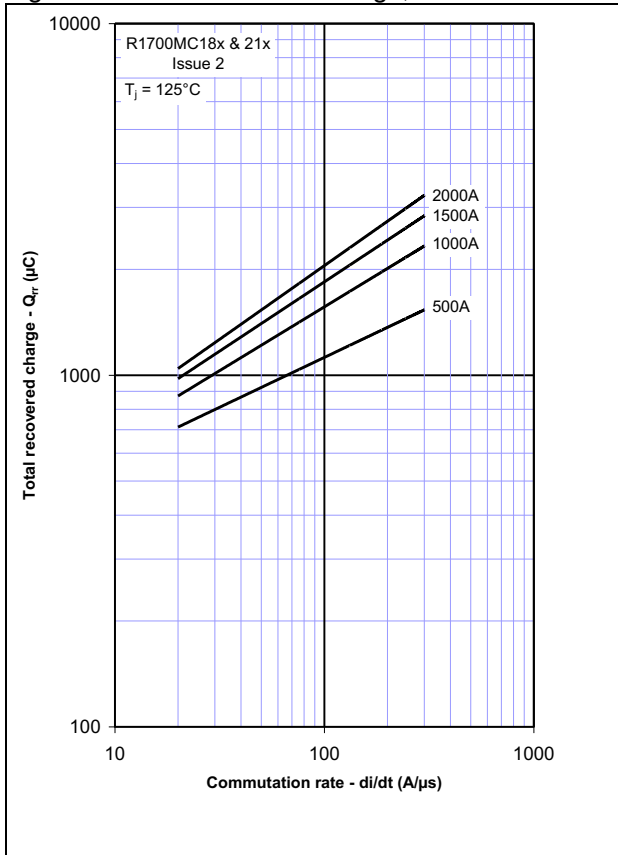

Figure 6 - Recovered charge,  $Q_{ra}$  (50% chord)

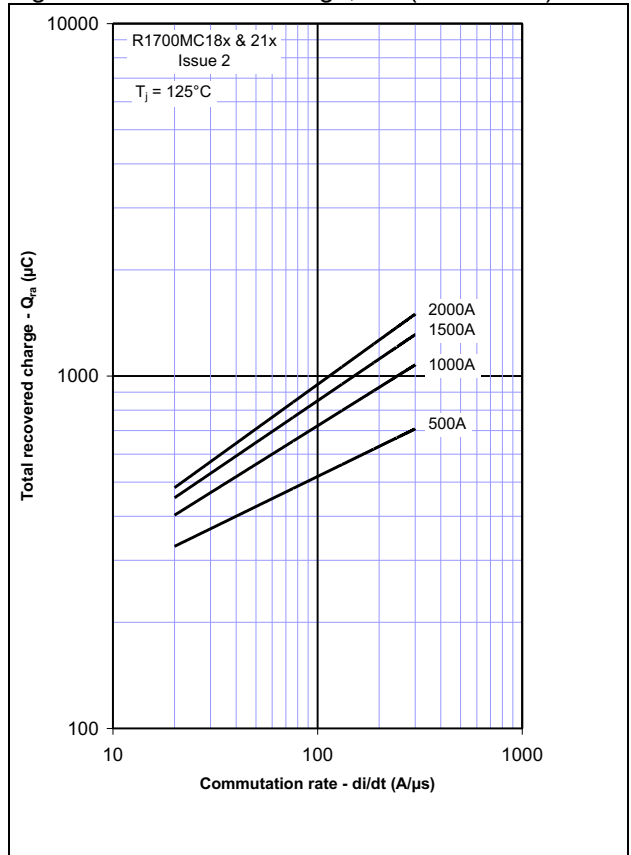

Figure 7 - Peak reverse recovery current,  $I_{rm}$

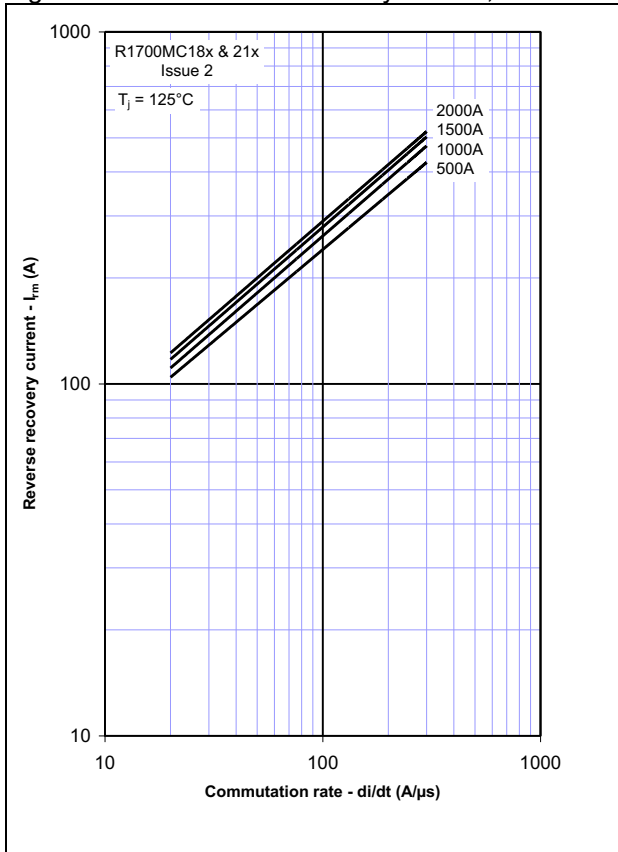

Figure 8 - Maximum recovery time,  $t_{rr}$  (50% chord)

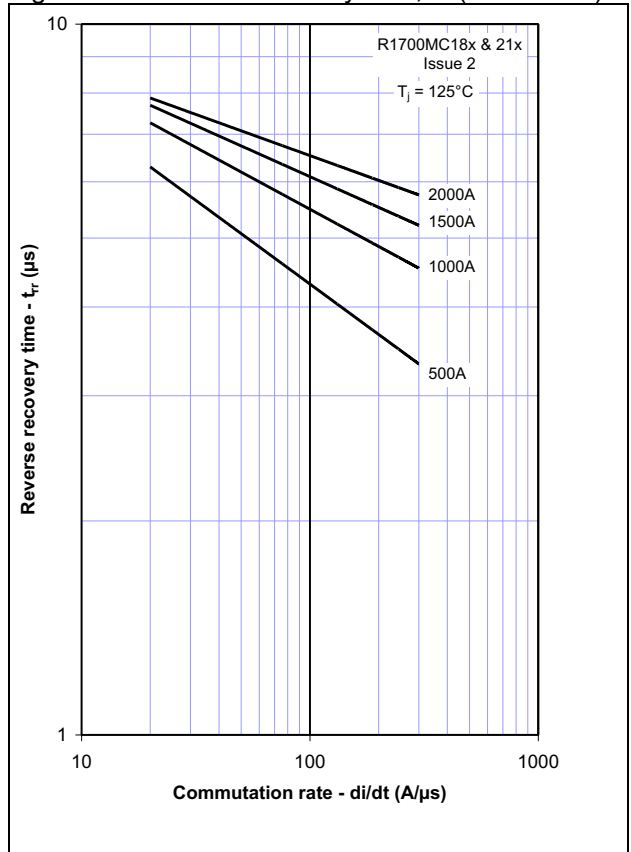

Figure 9 – Reverse recovery energy per pulse

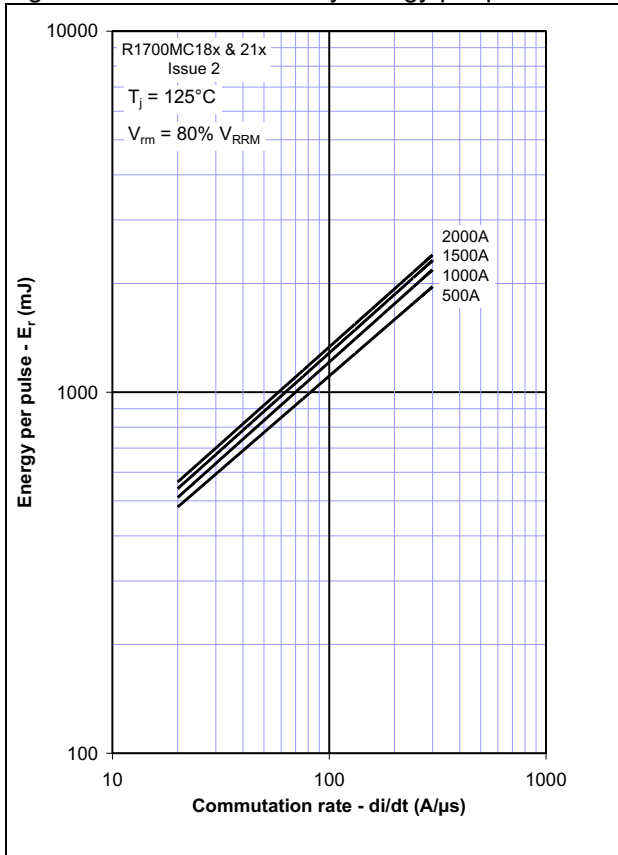

Figure 10 - Sine wave energy per pulse

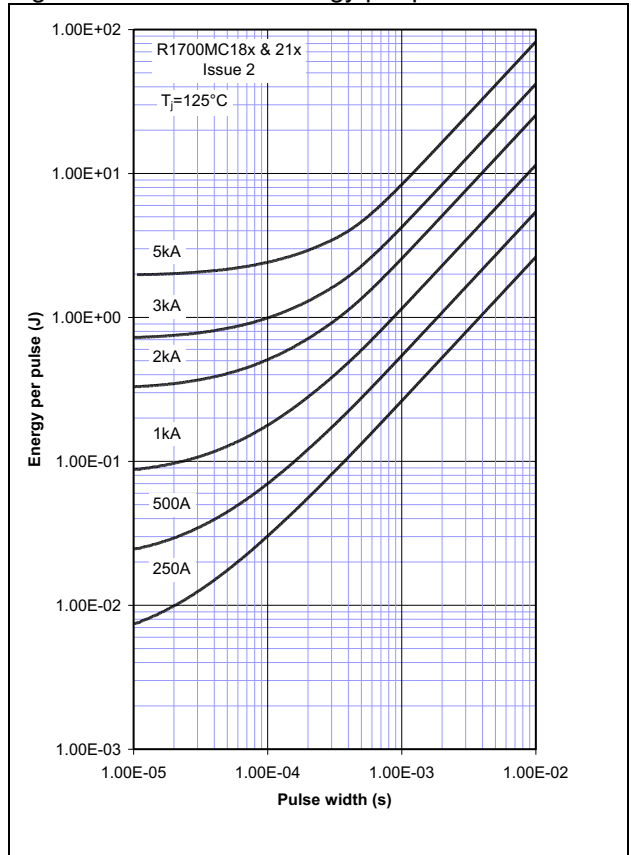

Figure 11 - Sine wave frequency ratings

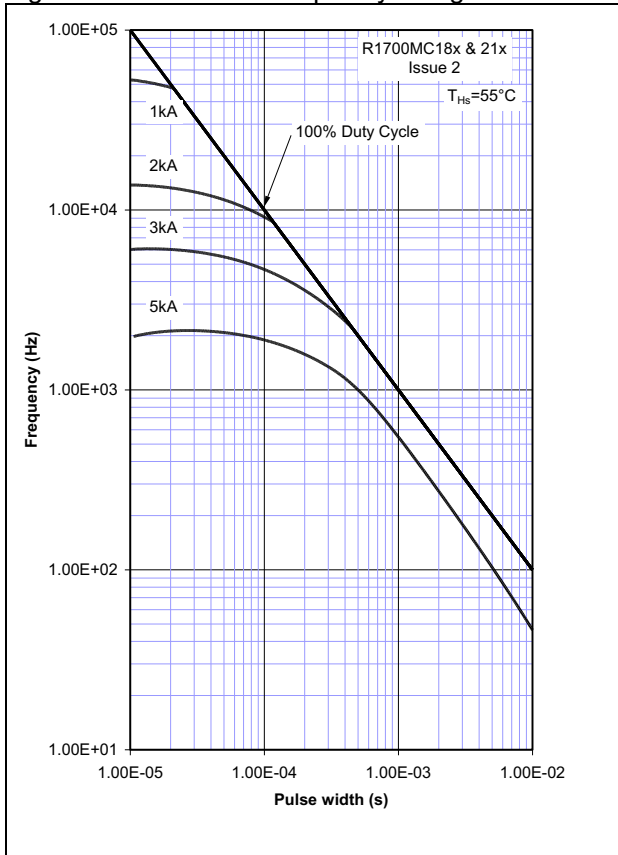

Figure 12 - Sine wave frequency ratings

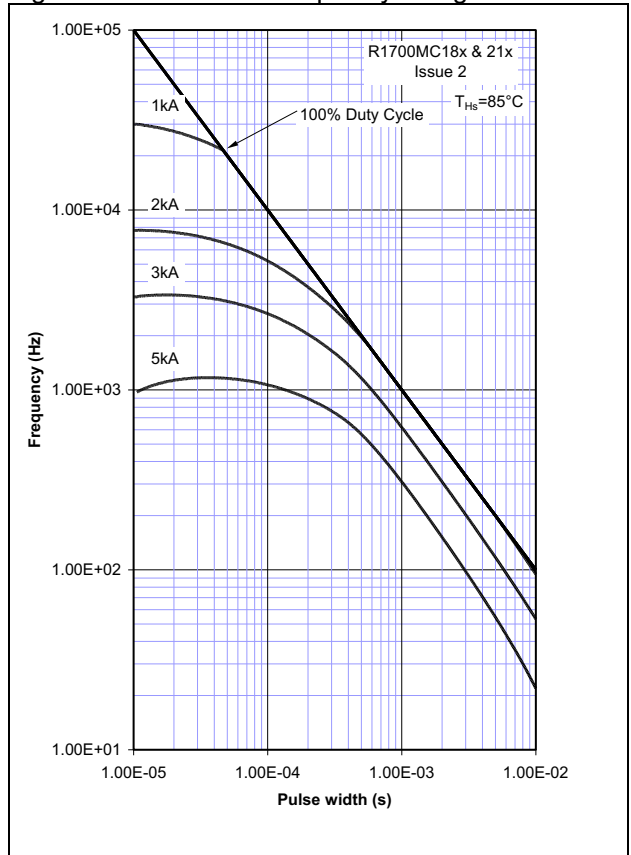

Figure 13 - Square wave frequency ratings

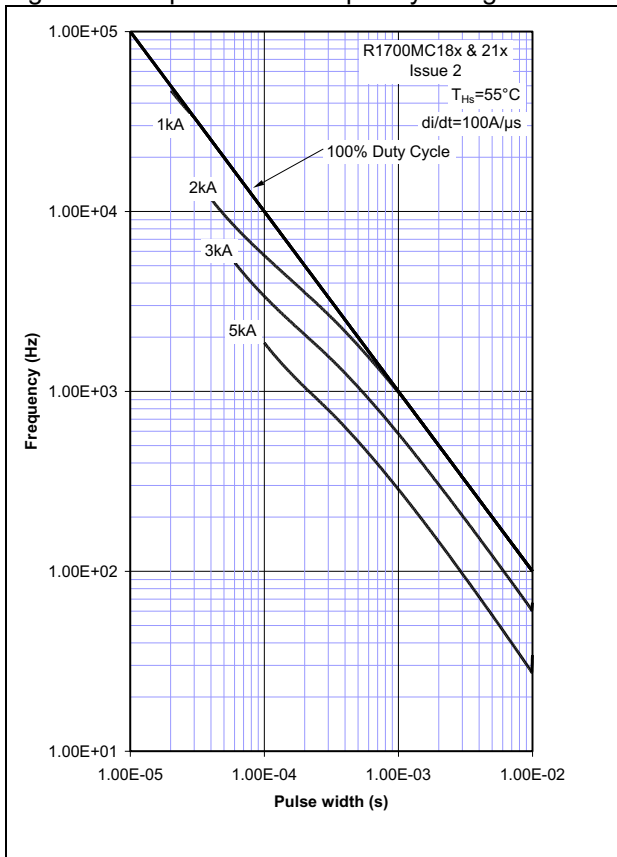

Figure 14 - Square wave frequency ratings

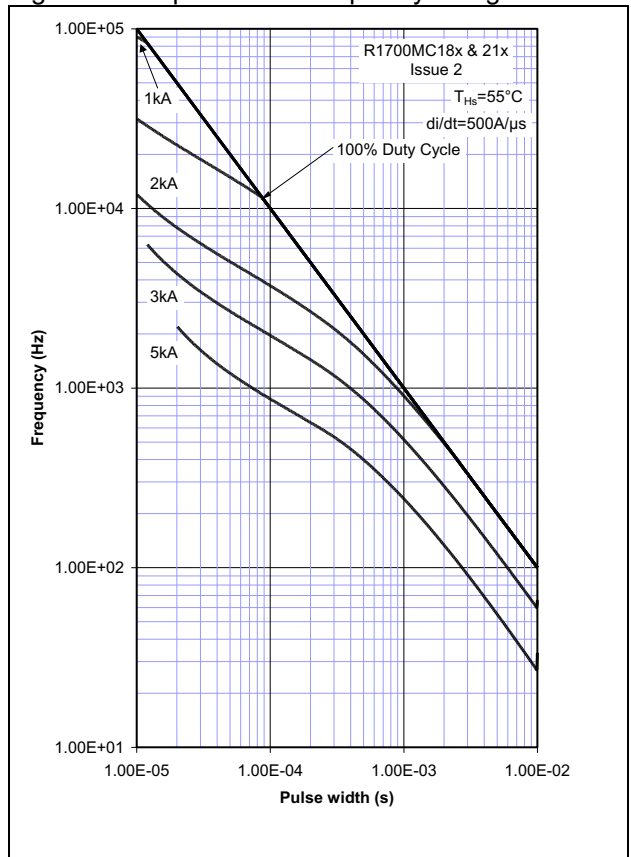

Figure 15 - Square wave frequency ratings

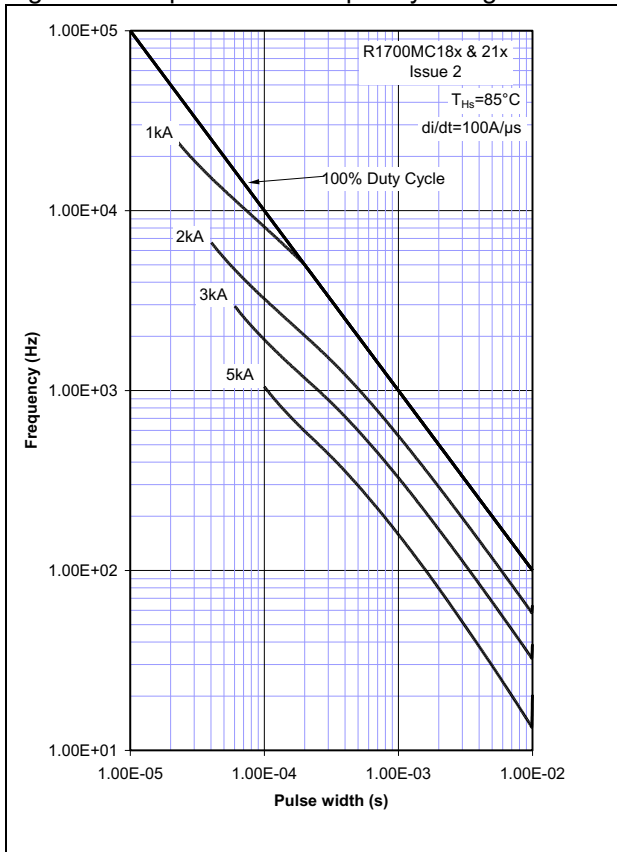

Figure 16 - Square wave frequency ratings

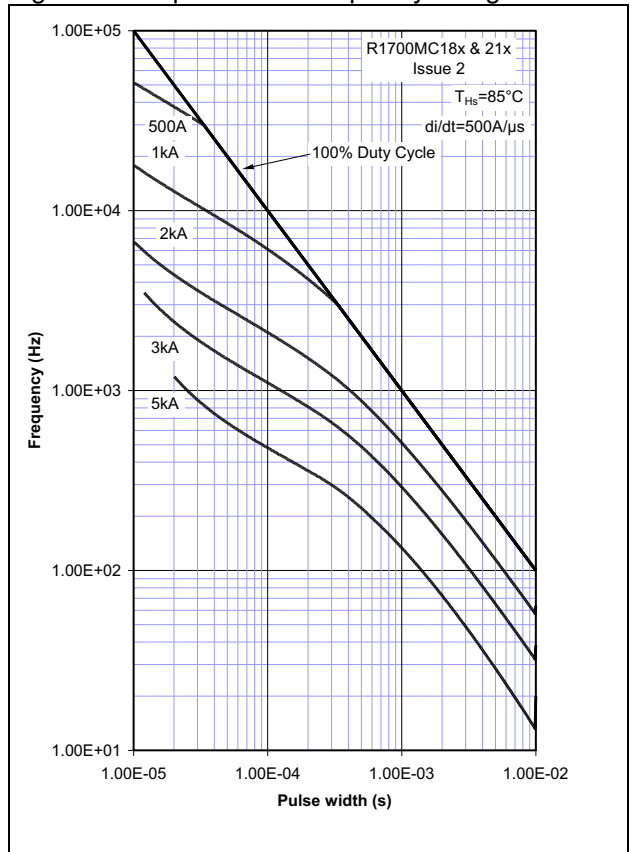

Figure 17 - Square wave energy per pulse

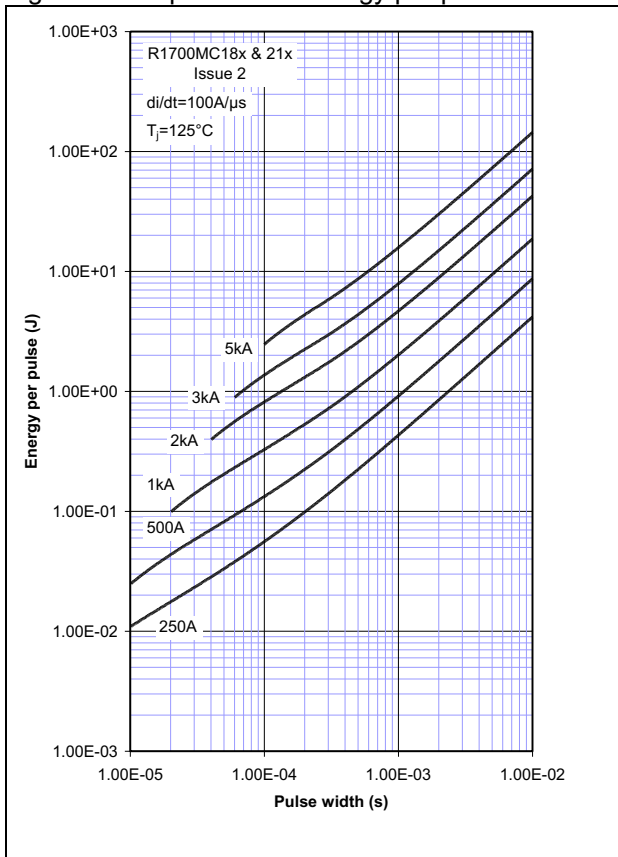

Figure 18 - Square wave energy per pulse

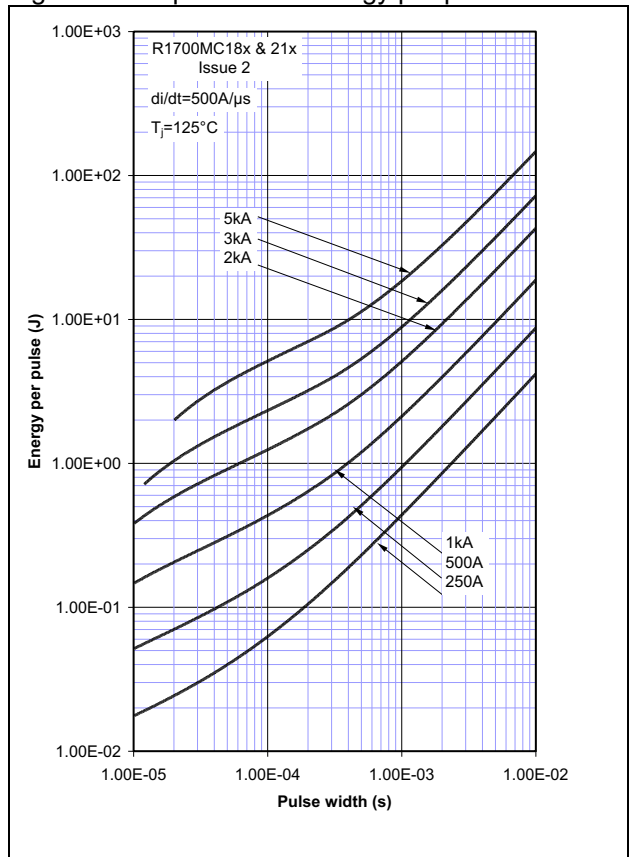
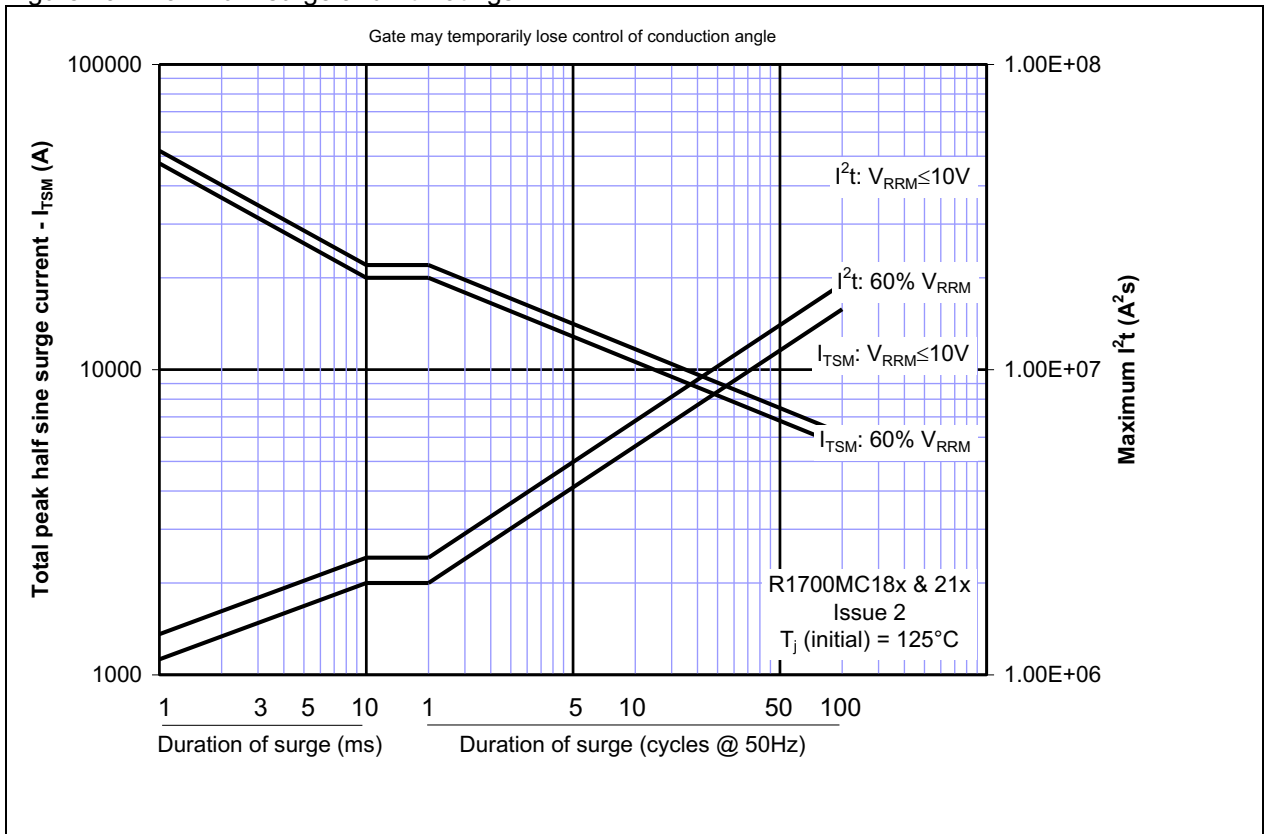
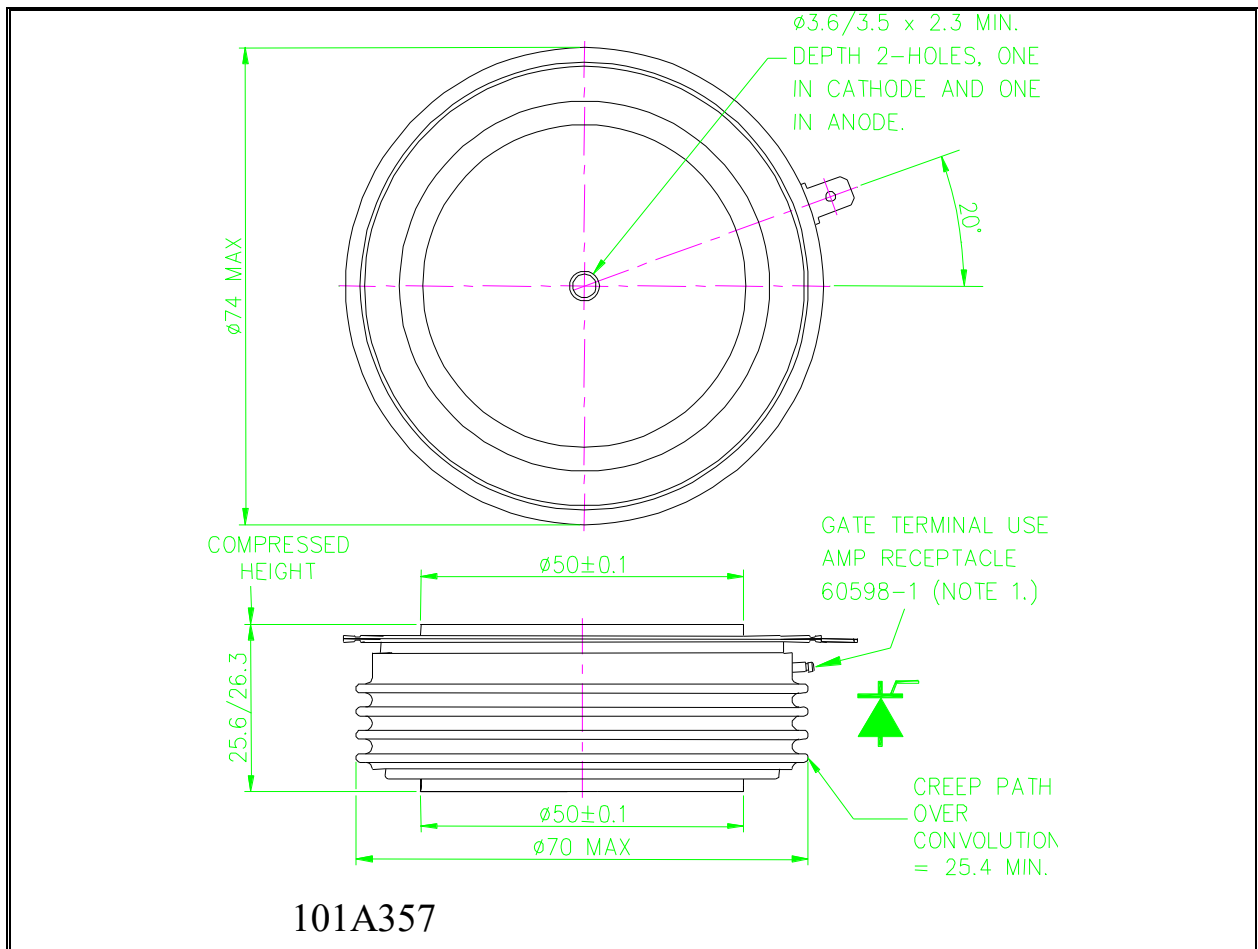

Figure 19 - Maximum surge and  $I^2t$  Ratings



**Outline Drawing & Ordering Information**



**ORDERING INFORMATION**

(Please quote 10 digit code as below)

| R1700           | MC                             | ◆ ◆  | #   |
|-----------------|--------------------------------|--|---|
| Fixed Type Code | Outline Code<br>MC=27mm height | Fixed Voltage Code<br>$V_{DRM}/100$<br>18 & 21 | $t_q$ Code<br>E=25 $\mu$ s, F=30 $\mu$ s, G=35 $\mu$ s,<br>H=40 $\mu$ s, J=50 $\mu$ s |

Typical order code: R1700MC21E – 2100V  $V_{DRM}$ , 1800V  $V_{RRM}$  25 $\mu$ s  $t_q$ , 26.3mm clamp height capsule

**IXYS Semiconductor GmbH**  
Edisonstraße 15  
D-68623 Lampertheim  
Tel: +49 6206 503-0  
Fax: +49 6206 503-627  
E-mail: [marcom@ixys.de](mailto:marcom@ixys.de)



**IXYS UK Westcode Ltd**  
Langley Park Way, Langley Park,  
Chippenham, Wiltshire, SN15 1GE.  
Tel: +44 (0)1249 444524  
Fax: +44 (0)1249 659448  
E-mail: [sales@ixysuk.com](mailto:sales@ixysuk.com)

**IXYS Corporation**  
1590 Buckeye Drive  
Milpitas CA 95035-7418  
Tel: +1 (408) 457 9000  
Fax: +1 (408) 496 0670  
E-mail: [sales@ixys.net](mailto:sales@ixys.net)

[www.ixysuk.com](http://www.ixysuk.com)

[www.ixys.com](http://www.ixys.com)

**IXYS Long Beach**  
IXYS Long Beach, Inc  
2500 Mira Mar Ave, Long Beach  
CA 90815  
Tel: +1 (562) 296 6584  
Fax: +1 (562) 296 6585  
E-mail: [service@ixyslongbeach.com](mailto:service@ixyslongbeach.com)

The information contained herein is confidential and is protected by Copyright. The information may not be used or disclosed except with the written permission of and in the manner permitted by the proprietors IXYS UK Westcode Ltd.

© IXYS UK Westcode Ltd.

In the interest of product improvement, IXYS UK Westcode Ltd reserves the right to change specifications at any time without prior notice.

Devices with a suffix code (2-letter or letter/digit/letter combination) added to their generic code are not necessarily subject to the conditions and limits contained in this report.



---

Disclaimer Notice - Information furnished is believed to be accurate and reliable. However, users should independently evaluate the suitability of and test each product selected for their own applications. Littelfuse products are not designed for, and may not be used in, all applications. Read complete Disclaimer Notice at [www.littelfuse.com/disclaimer-electronics](http://www.littelfuse.com/disclaimer-electronics).