

# TrenchP™ Power MOSFET

**IXTT76P10THV**  
**IXTA76P10T**  
**IXTP76P10T**  
**IXTH76P10T**

$V_{DSS} = -100V$   
 $I_{D25} = -76A$   
 $R_{DS(on)} \leq 25m\Omega$

P-Channel Enhancement Mode  
Avalanche Rated

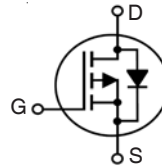

| Symbol        | Test Conditions   | Maximum Ratings |            |
|---------------|---|-----------------|------------|
| $V_{DSS}$     | $T_J = 25^\circ C$ to $150^\circ C$                       | - 100           | V          |
| $V_{DGR}$     | $T_J = 25^\circ C$ to $150^\circ C$ , $R_{GS} = 1M\Omega$ | - 100           | V          |
| $V_{GSS}$     | Continuous  | $\pm 15$        | V          |
| $V_{GSM}$     | Transient   | $\pm 25$        | V          |
| $I_{D25}$     | $T_C = 25^\circ C$  | - 76            | A          |
| $I_{DM}$      | $T_C = 25^\circ C$ , Pulse Width Limited by $T_{JM}$      | - 230           | A          |
| $I_A$         | $T_C = 25^\circ C$  | - 38            | A          |
| $E_{AS}$      | $T_C = 25^\circ C$  | 1               | J          |
| $P_D$         | $T_C = 25^\circ C$  | 298             | W          |
| $T_J$         |   | -55 ... +150    | $^\circ C$ |
| $T_{JM}$      |   | 150             | $^\circ C$ |
| $T_{stg}$     |   | -55 ... +150    | $^\circ C$ |
| $T_L$         | Maximum Lead Temperature for Soldering                    | 300             | $^\circ C$ |
| $T_{SOLD}$    | 1.6 mm (0.062in.) from Case for 10s                       | 260             | $^\circ C$ |
| $M_d$         | Mounting Torque (TO-220 & TO-247)                         | 1.13 / 10       | Nm/lb.in.  |
| <b>Weight</b> | TO-263  | 2.5             | g          |
|               | TO-220  | 3.0             | g          |
|               | TO-268HV  | 4.0             | g          |
|               | TO-247  | 6.0             | g          |

| Symbol       | Test Conditions<br>( $T_J = 25^\circ C$ , Unless Otherwise Specified) | Characteristic Values |      |               |
|--------------|---|-----------------------|------|---------------|
|              |   | Min.                  | Typ. | Max.          |
| $BV_{DSS}$   | $V_{GS} = 0V$ , $I_D = -250\mu A$                                     | -100                  |      | V             |
| $V_{GS(th)}$ | $V_{DS} = V_{GS}$ , $I_D = -250\mu A$                                 | - 2.0                 |      | V             |
| $I_{GSS}$    | $V_{GS} = \pm 15V$ , $V_{DS} = 0V$                                    |                       |      | $\pm 100$ nA  |
| $I_{DSS}$    | $V_{DS} = V_{DSS}$ , $V_{GS} = 0V$<br>$T_J = 125^\circ C$             |                       |      | - 15 $\mu A$  |
|              |   |                       |      | - 750 $\mu A$ |
| $R_{DS(on)}$ | $V_{GS} = -10V$ , $I_D = 0.5 \cdot I_{D25}$ , Note 1                  |                       |      | 25 m $\Omega$ |

TO-268HV  
(IXTT)

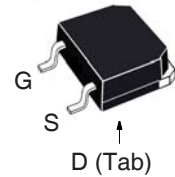

TO-263 AA  
(IXTA)

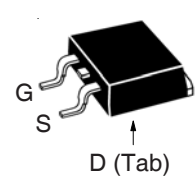

TO-220AB  
(IXTP)

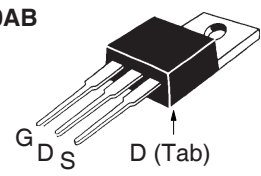

TO-247  
(IXTH)

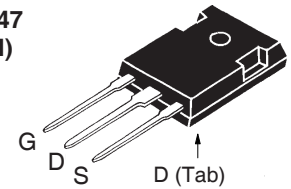

G = Gate      D = Drain  
S = Source    Tab = Drain

### Features

- International Standard Packages
- Avalanche Rated
- Extended FBSOA
- Fast Intrinsic Diode
- Low  $R_{DS(ON)}$  and  $Q_G$

### Advantages

- Easy to Mount
- Space Savings

### Applications

- High-Side Switching
- Push Pull Amplifiers
- DC Choppers
- Automatic Test Equipment
- Current Regulators
- Battery Charger Applications

| Symbol  | Test Conditions<br>( $T_J = 25^\circ\text{C}$ , Unless Otherwise Specified)   | Characteristic Values |              |  |
|---|---|-----------------------|--------------|--|
|   |   | Min.                  | Typ.         | Max.                                     |
| $g_{fs}$                                      | $V_{DS} = -10\text{V}$ , $I_D = 0.5 \cdot I_{D25}$ , Note 1   | 35                    | 58           | S  |
| $C_{iss}$<br>$C_{oss}$<br>$C_{rss}$           | $V_{GS} = 0\text{V}$ , $V_{DS} = -25\text{V}$ , $f = 1\text{MHz}$   |                       | 13.7         | nF                                       |
|   |   |                       | 890          | pF                                       |
|   |   |                       | 275          | pF                                       |
| $t_{d(on)}$<br>$t_r$<br>$t_{d(off)}$<br>$t_f$ | <b>Resistive Switching Times</b><br>$V_{GS} = -10\text{V}$ , $V_{DS} = 0.5 \cdot V_{DSS}$ , $I_D = 0.5 \cdot I_{D25}$<br>$R_G = 1\Omega$ (External) |                       | 25           | ns                                       |
|   |   |                       | 40           | ns                                       |
|   |   |                       | 52           | ns                                       |
|   |   |                       | 20           | ns                                       |
| $Q_{g(on)}$<br>$Q_{gs}$<br>$Q_{gd}$           | $V_{GS} = -10\text{V}$ , $V_{DS} = 0.5 \cdot V_{DSS}$ , $I_D = 0.5 \cdot I_{D25}$   |                       | 197          | nC                                       |
|   |   |                       | 65           | nC                                       |
|   |   |                       | 65           | nC                                       |
| $R_{thJC}$<br>$R_{thCS}$                      | TO-220<br>TO-247  |                       |              | 0.42 $^\circ\text{C/W}$                  |
|   |   |                       | 0.50<br>0.21 | $^\circ\text{C/W}$<br>$^\circ\text{C/W}$ |

#### Source-Drain Diode

| Symbol                           | Test Conditions<br>( $T_J = 25^\circ\text{C}$ , Unless Otherwise Specified)                             | Characteristic Values |      |         |
|----------------------------------|---|-----------------------|------|---------|
|                                  |   | Min.                  | Typ. | Max.    |
| $I_S$                            | $V_{GS} = 0\text{V}$  |                       |      | - 76 A  |
| $I_{SM}$                         | Repetitive, Pulse Width Limited by $T_{JM}$   |                       |      | - 304 A |
| $V_{SD}$                         | $I_F = -38\text{A}$ , $V_{GS} = 0\text{V}$ , Note 1   |                       |      | -1.3 V  |
| $t_{rr}$<br>$Q_{RM}$<br>$I_{RM}$ | $I_F = -38\text{A}$ , $-di/dt = -100\text{A}/\mu\text{s}$<br>$V_R = -50\text{V}$ , $V_{GS} = 0\text{V}$ |                       | 70   | ns      |
|                                  |   |                       | 215  | nC      |
|                                  |   |                       | - 6  | A       |

Note 1: Pulse test,  $t \leq 300\mu\text{s}$ , duty cycle,  $d \leq 2\%$ .

IXYS Reserves The Right to Change Limits, Test Conditions, and Dimensions.

IXYS MOSFETs and IGBTs are covered by one or more of the following U.S. patents:

|           |           |           |           |              |              |              |              |              |             |
|-----------|-----------|-----------|-----------|--------------|--------------|--------------|--------------|--------------|-------------|
| 4,835,592 | 4,931,844 | 5,049,961 | 5,237,481 | 6,162,665    | 6,404,065 B1 | 6,683,344    | 6,727,585    | 7,005,734 B2 | 7,157,338B2 |
| 4,860,072 | 5,017,508 | 5,063,307 | 5,381,025 | 6,259,123 B1 | 6,534,343    | 6,710,405 B2 | 6,759,692    | 7,063,975 B2 |             |
| 4,881,106 | 5,034,796 | 5,187,117 | 5,486,715 | 6,306,728 B1 | 6,583,505    | 6,710,463    | 6,771,478 B2 | 7,071,537    |             |

Fig. 1. Output Characteristics @  $T_J = 25^\circ\text{C}$

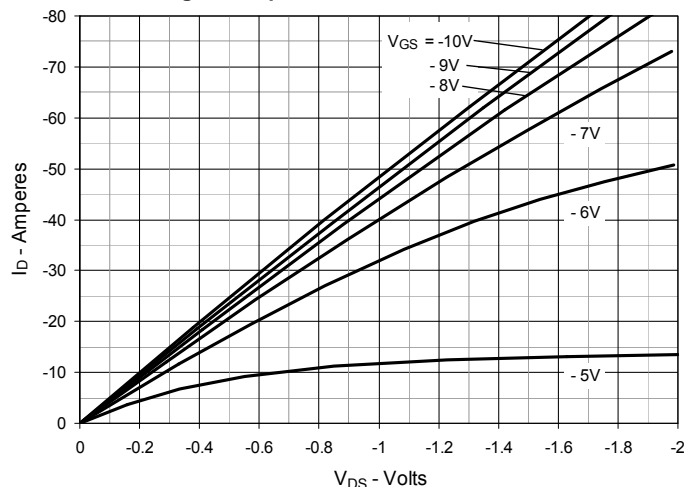

Fig. 2. Extended Output Characteristics @  $T_J = 25^\circ\text{C}$

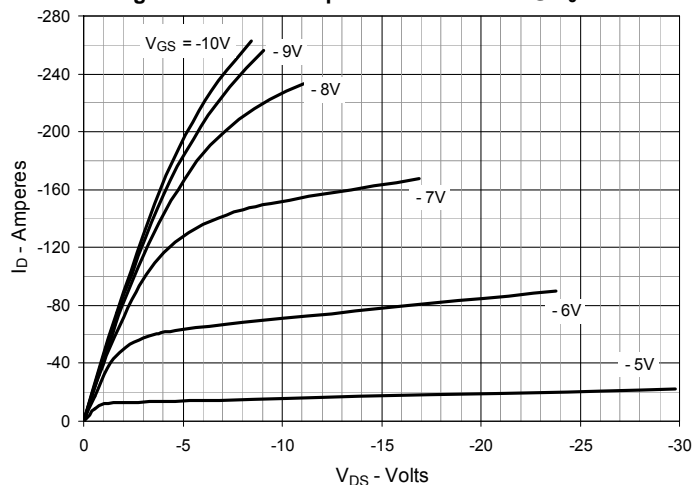

Fig. 3. Output Characteristics @  $T_J = 125^\circ\text{C}$

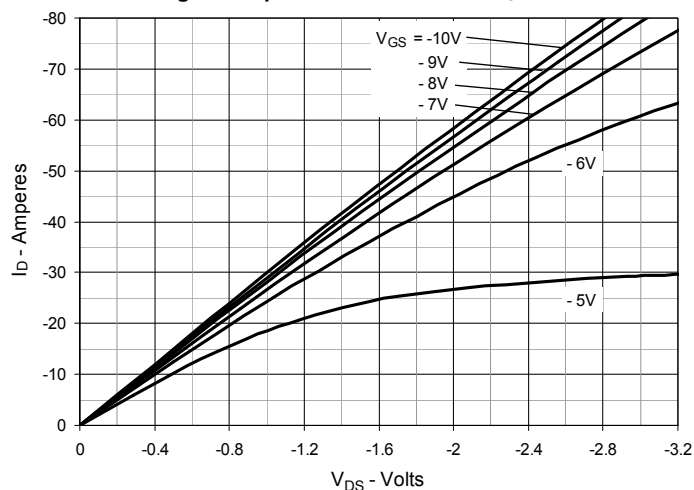

Fig. 4.  $R_{DS(on)}$  Normalized to  $I_D = -38\text{A}$  Value vs. Junction Temperature

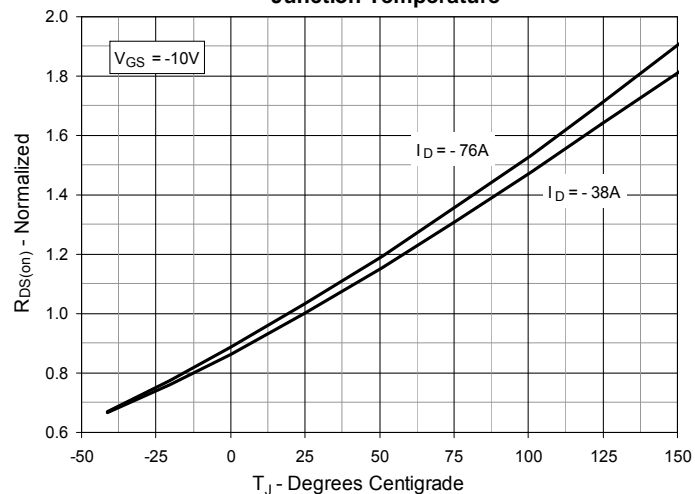

Fig. 5.  $R_{DS(on)}$  Normalized to  $I_D = -38\text{A}$  Value vs. Drain Current

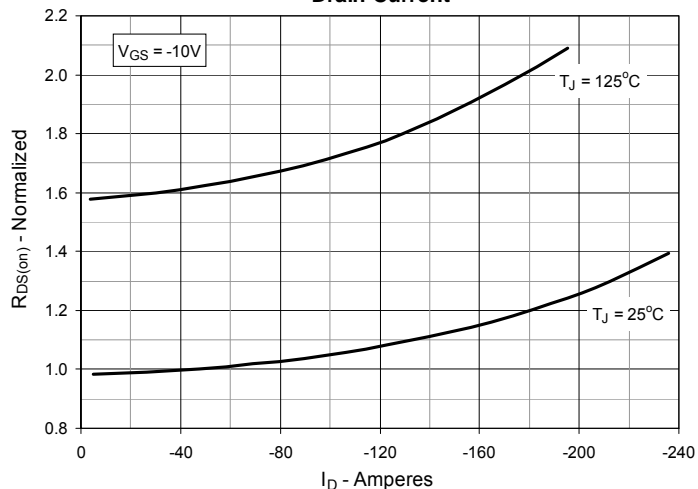

Fig. 6. Maximum Drain Current vs. Case Temperature

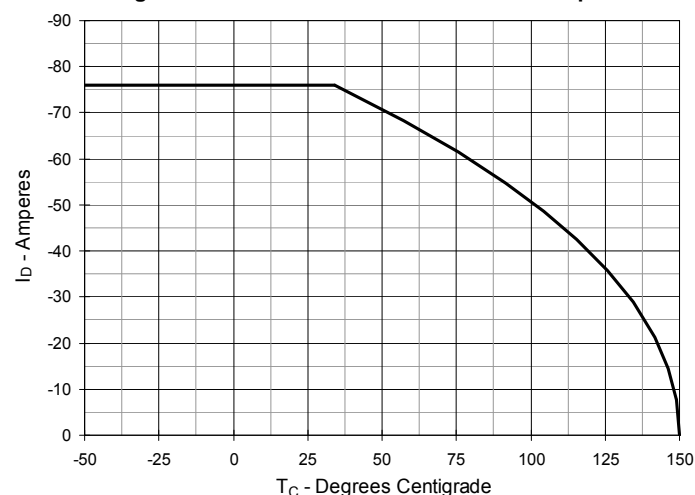

Fig. 7. Input Admittance

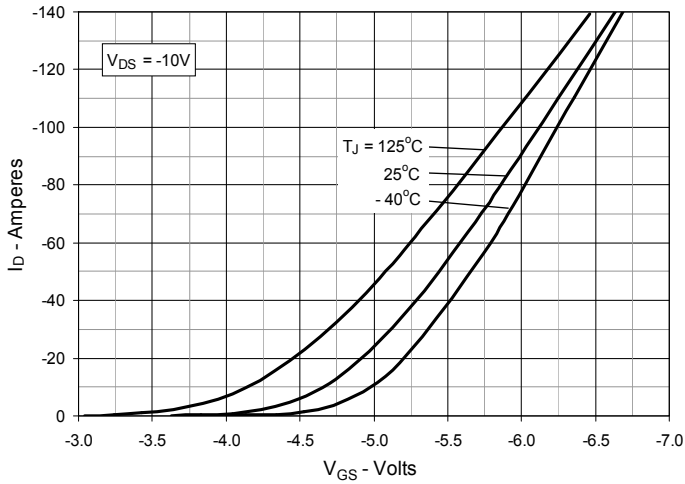

Fig. 8. Transconductance

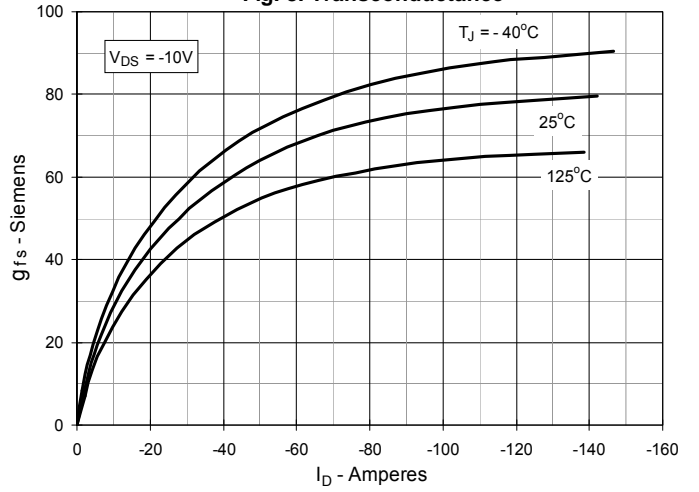

Fig. 9. Forward Voltage Drop of Intrinsic Diode

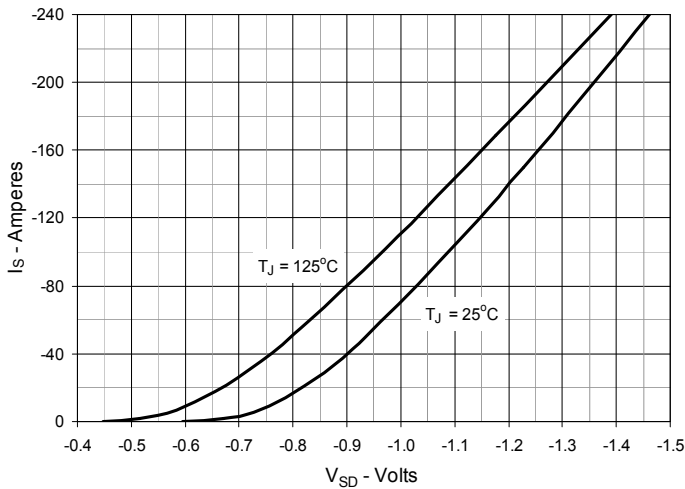

Fig. 10. Gate Charge

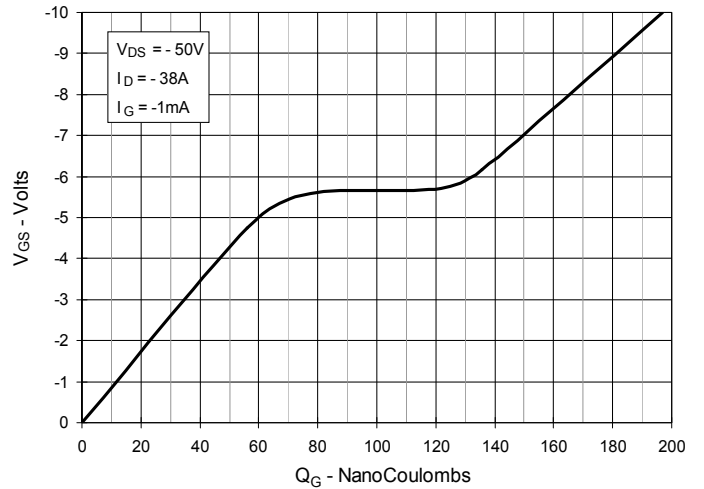

Fig. 11. Capacitance

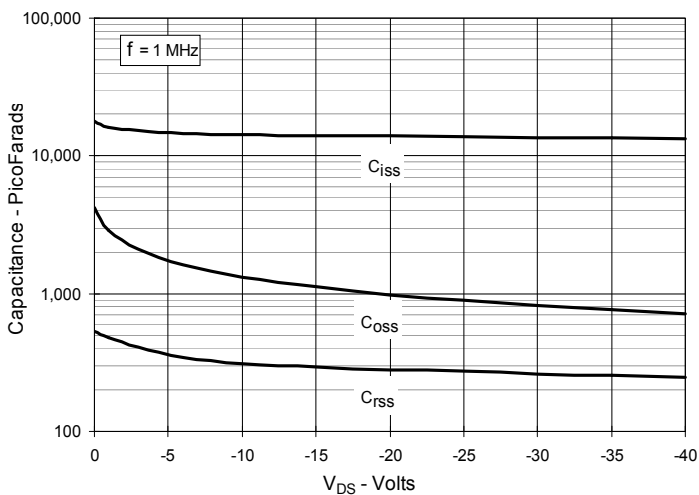
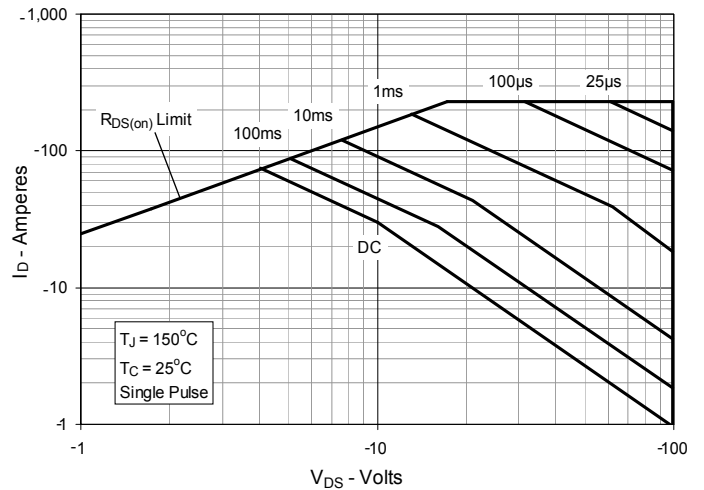
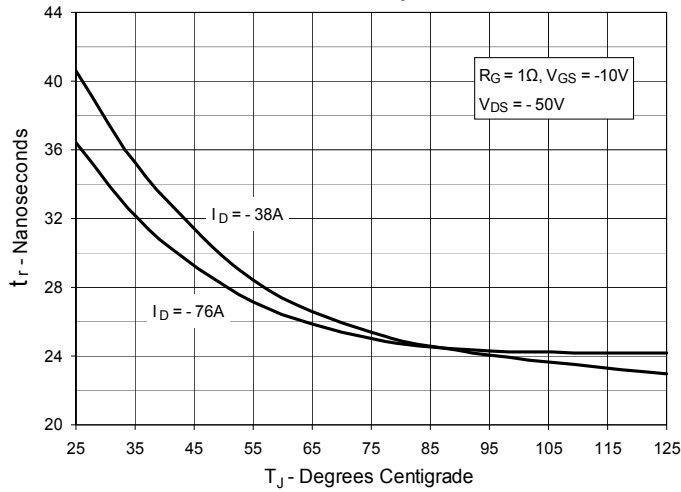

Fig. 12. Forward-Bias Safe Operating Area



**Fig. 13. Resistive Turn-on Rise Time vs. Junction Temperature**



**Fig. 14. Resistive Turn-on Rise Time vs. Drain Current**

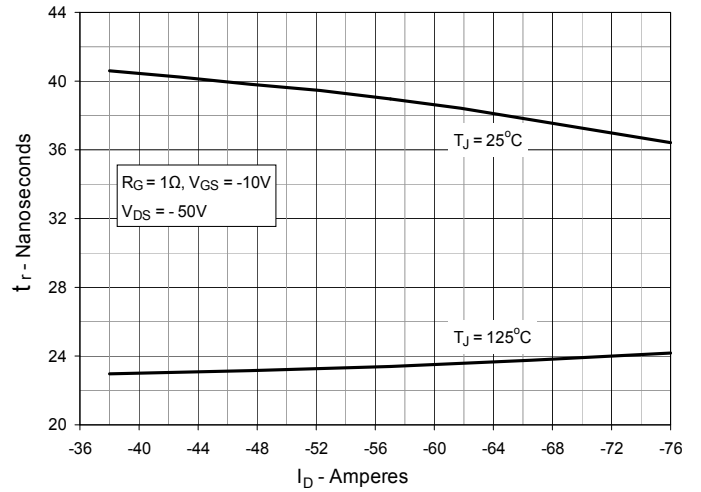

**Fig. 15. Resistive Turn-on Switching Times vs. Gate Resistance**

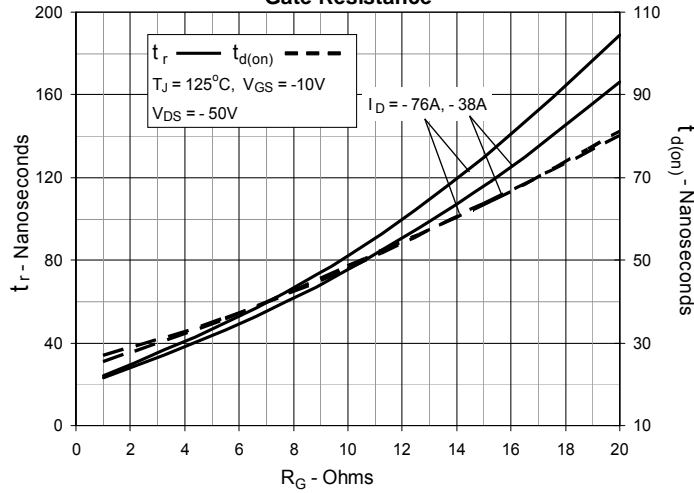

**Fig. 16. Resistive Turn-off Switching Times vs. Junction Temperature**

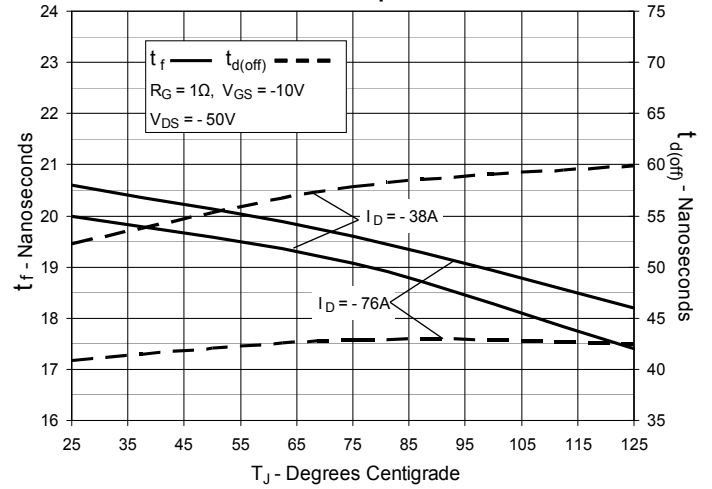

**Fig. 17. Resistive Turn-off Switching Times vs. Drain Current**

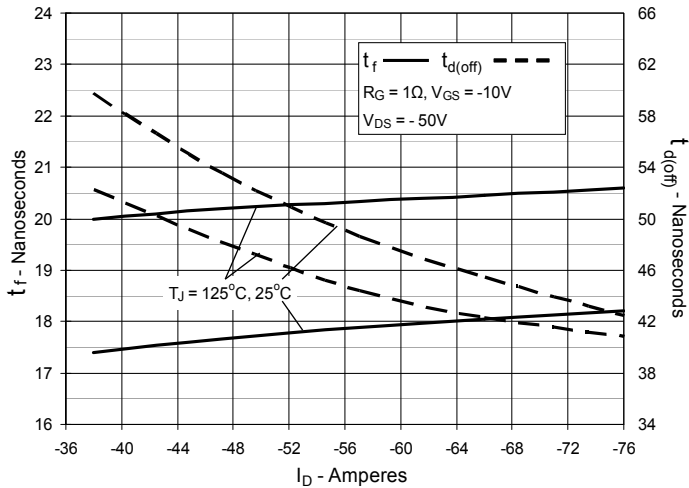

**Fig. 18. Resistive Turn-off Switching Times vs. Gate Resistance**

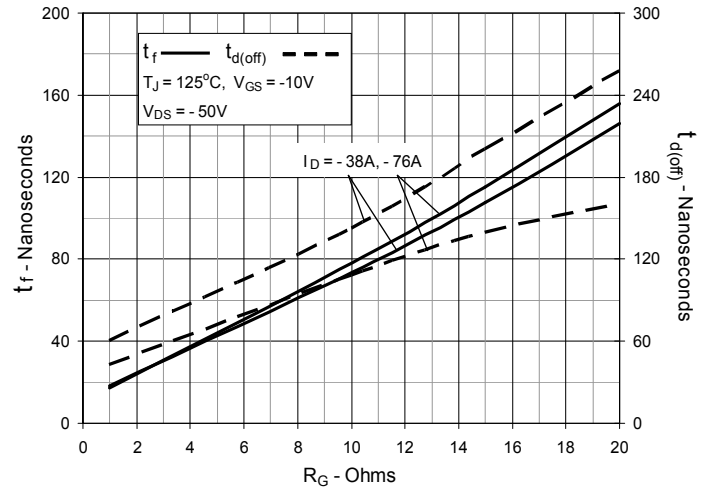

**Fig. 19. Maximum Transient Thermal Impedance**

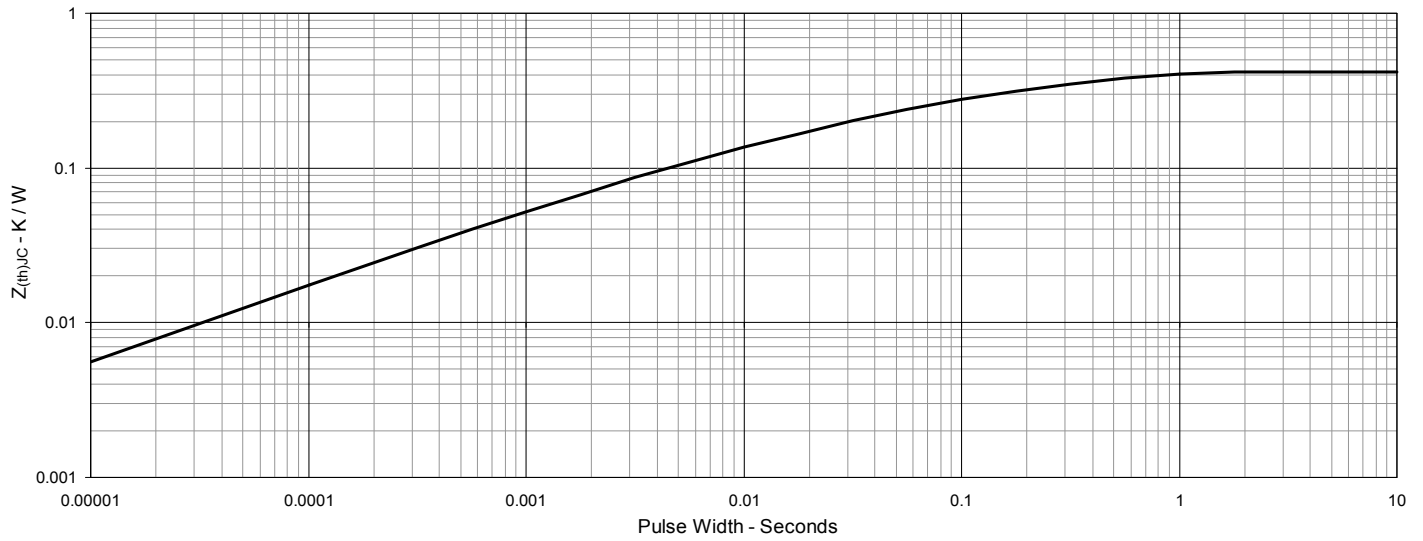

## TO-268HV Outline

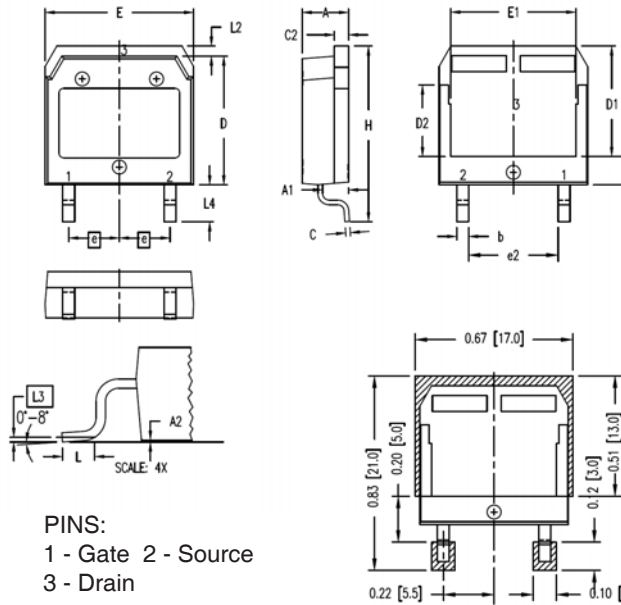

**PINS:**  
 1 - Gate 2 - Source  
 3 - Drain

| SYM  | INCHES   |      | MILLIMETER |       |
|------|----------|------|------------|-------|
|      | MIN      | MAX  | MIN        | MAX   |
| A    | .193     | .201 | 4.90       | 5.10  |
| A1   | .106     | .114 | 2.70       | 2.90  |
| A2   | .001     | .010 | 0.02       | 0.25  |
| b    | .045     | .057 | 1.15       | 1.45  |
| C    | .016     | .026 | 0.40       | 0.65  |
| C2   | .057     | .063 | 1.45       | 1.60  |
| D    | .543     | .551 | 13.80      | 14.00 |
| D1   | .465     | .476 | 11.80      | 12.10 |
| D2   | .295     | .307 | 7.50       | 7.80  |
| D3   | .114     | .126 | 2.90       | 3.20  |
| E    | .624     | .632 | 15.85      | 16.05 |
| E1   | .524     | .535 | 13.30      | 13.60 |
| e    | .215 BSC |      | 5.45 BSC   |       |
| (e2) | .374     | .386 | 9.50       | 9.80  |
| H    | .736     | .752 | 18.70      | 19.10 |
| L    | .067     | .079 | 1.70       | 2.00  |
| L2   | .039     | .045 | 1.00       | 1.15  |
| L3   | .010 BSC |      | 0.25 BSC   |       |
| L4   | .150     | .161 | 3.80       | 4.10  |

## TO-263 Outline

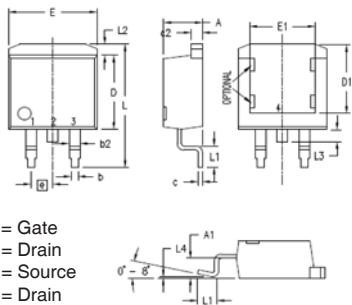

1 = Gate  
 2 = Drain  
 3 = Source  
 4 = Drain

| SYM | INCHES   |      | MILLIMETERS |       |
|-----|----------|------|-------------|-------|
|     | MIN      | MAX  | MIN         | MAX   |
| A   | .160     | .190 | 4.06        | 4.83  |
| A1  | .080     | .110 | 2.03        | 2.79  |
| b   | .020     | .039 | 0.51        | 0.99  |
| b2  | .045     | .055 | 1.14        | 1.40  |
| c   | .016     | .029 | 0.40        | 0.74  |
| c2  | .045     | .055 | 1.14        | 1.40  |
| D   | .340     | .380 | 8.64        | 9.65  |
| D1  | .315     | .350 | 8.00        | 8.89  |
| E   | .380     | .410 | 9.65        | 10.41 |
| E1  | .245     | .320 | 6.22        | 8.13  |
| e   | .100 BSC |      | 2.54 BSC    |       |
| L   | .575     | .625 | 14.61       | 15.88 |
| L1  | .090     | .110 | 2.29        | 2.79  |
| L2  | .040     | .055 | 1.02        | 1.40  |
| L3  | .050     | .070 | 1.27        | 1.78  |
| L4  | 0        | .005 | 0           | 0.13  |

## TO-220 Outline

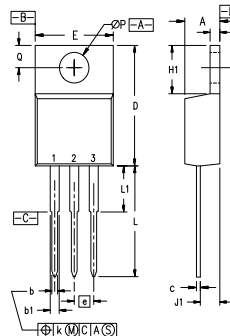

Pins: 1 - Gate 2 - Drain  
 3 - Source

| SYM | INCHES   |      | MILLIMETERS |       |
|-----|----------|------|-------------|-------|
|     | MIN      | MAX  | MIN         | MAX   |
| A   | .170     | .190 | 4.32        | 4.83  |
| b   | .025     | .040 | 0.64        | 1.02  |
| b1  | .045     | .065 | 1.15        | 1.65  |
| c   | .014     | .022 | 0.35        | 0.56  |
| D   | .580     | .630 | 14.73       | 16.00 |
| E   | .390     | .420 | 9.91        | 10.66 |
| e   | .100 BSC |      | 2.54 BSC    |       |
| F   | .045     | .055 | 1.14        | 1.40  |
| H1  | .230     | .270 | 5.85        | 6.85  |
| J1  | .090     | .110 | 2.29        | 2.79  |
| k   | 0        | .015 | 0           | 0.38  |
| L   | .500     | .550 | 12.70       | 13.97 |
| L1  | .110     | .230 | 2.79        | 5.84  |
| ØP  | .139     | .161 | 3.53        | 4.08  |
| Q   | .100     | .125 | 2.54        | 3.18  |

## TO-247 Outline

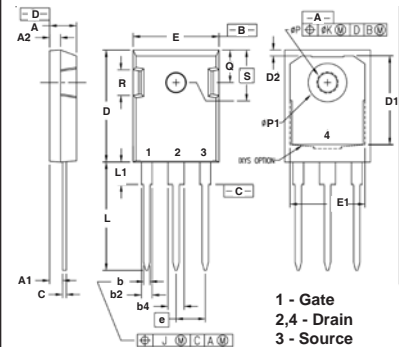

1 - Gate  
 2,4 - Drain  
 3 - Source

| Dim. | Millimeter |       | Inches    |       |
|------|------------|-------|-----------|-------|
|      | min        | max   | min       | max   |
| A    | 4.70       | 5.30  | 0.185     | 0.209 |
| A1   | 2.21       | 2.59  | 0.087     | 0.102 |
| A2   | 1.50       | 2.49  | 0.059     | 0.098 |
| b    | 0.99       | 1.40  | 0.039     | 0.055 |
| b2   | 1.65       | 2.39  | 0.065     | 0.094 |
| b4   | 2.59       | 3.43  | 0.102     | 0.135 |
| c    | 0.38       | 0.89  | 0.015     | 0.035 |
| D    | 20.79      | 21.45 | 0.819     | 0.845 |
| D1   | 13.07      | -     | 0.515     | -     |
| D2   | 0.51       | 1.35  | 0.020     | 0.053 |
| E    | 15.48      | 16.24 | 0.610     | 0.640 |
| E1   | 13.45      | -     | 0.53      | -     |
| E2   | 4.31       | 5.48  | 0.170     | 0.216 |
| e    | 5.45 BSC   |       | 0.215 BSC |       |
| L    | 19.80      | 20.30 | 0.078     | 0.800 |
| L1   | -          | 4.49  | -         | 0.177 |
| Ø P  | 3.55       | 3.65  | 0.140     | 0.144 |
| Ø P1 | -          | 7.39  | -         | 0.290 |
| Q    | 5.38       | 6.19  | 0.212     | 0.244 |
| S    | 6.14 BSC   |       | 0.242 BSC |       |



---

Disclaimer Notice - Information furnished is believed to be accurate and reliable. However, users should independently evaluate the suitability of and test each product selected for their own applications. Littelfuse products are not designed for, and may not be used in, all applications. Read complete Disclaimer Notice at [www.littelfuse.com/disclaimer-electronics](http://www.littelfuse.com/disclaimer-electronics).