

PolarP™ Power MOSFETs

P-Channel Enhancement Mode
Avalanche Rated

IXTA52P10P
IXTP52P10P
IXTQ52P10P
IXTH52P10P

$V_{DSS} = -100V$
 $I_{D25} = -52A$
 $R_{DS(on)} \leq 50m\Omega$

TO-263 AA (IXTA)

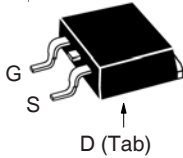

TO-220AB (IXTP)

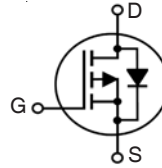
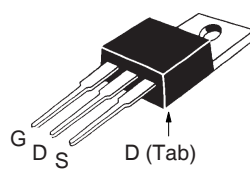

TO-3P (IXTQ)

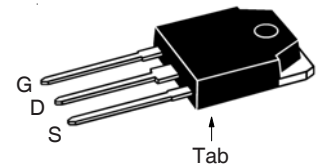

TO-247 (IXTH)

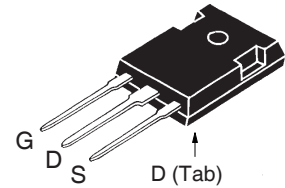

G = Gate D = Drain
S = Source Tab = Drain

Symbol	Test Conditions	Maximum Ratings	
V_{DSS}	$T_J = 25^\circ C$ to $150^\circ C$	-100	V
V_{DGR}	$T_J = 25^\circ C$ to $150^\circ C$, $R_{GS} = 1M\Omega$	-100	V
V_{GSS}	Continuous	± 20	V
V_{GSM}	Transient	± 30	V
I_{D25}	$T_C = 25^\circ C$	- 52	A
I_{DM}	$T_C = 25^\circ C$, Pulse Width Limited by T_{JM}	-130	A
I_A	$T_C = 25^\circ C$	- 52	A
E_{AS}	$T_C = 25^\circ C$	1.5	J
dv/dt	$I_S \leq I_{DM}$, $V_{DD} \leq V_{DSS}$, $T_J \leq 150^\circ C$	10	V/ns
P_D	$T_C = 25^\circ C$	300	W
T_J		-55 ... +150	$^\circ C$
T_{JM}		150	$^\circ C$
T_{stg}		-55 ... +150	$^\circ C$
T_L	1.6mm (0.062 in.) from Case for 10s	300	$^\circ C$
T_{SOLD}	Plastic body for 10s	260	$^\circ C$
M_d	Mounting Torque (TO-3P, TO-220, TO-247)	1.13/10	Nm/lb.in.
Weight	TO-263	2.5	g
	TO-220	3.0	g
	TO-3P	5.5	g
	TO-247	6.0	g

Features

- International Standard Packages
- Fast Intrinsic Diode
- Dynamic dv/dt Rated
- Avalanche Rated
- Rugged PolarP™ Process
- Low Q_G and $R_{ds(on)}$
- Low Drain-to-Tab Capacitance
- Low Package Inductance

Advantages

- Easy to Mount
- Space Savings
- High Power Density

Applications

- High-Side Switching
- Push-Pull Amplifiers
- DC Choppers
- Current Regulators
- Automatic Test Equipment

Symbol	Test Conditions ($T_J = 25^\circ C$, Unless Otherwise Specified)	Characteristic Values		
		Min.	Typ.	Max.
BV_{DSS}	$V_{GS} = 0V$, $I_D = -250\mu A$	-100		V
$V_{GS(th)}$	$V_{DS} = V_{GS}$, $I_D = -250\mu A$	- 2.0		V
I_{GSS}	$V_{GS} = \pm 20V$, $V_{DS} = 0V$			± 100 nA
I_{DSS}	$V_{DS} = V_{DSS}$, $V_{GS} = 0V$ $T_J = 125^\circ C$			-10 μA -150 μA
$R_{DS(on)}$	$V_{GS} = -10V$, $I_D = 0.5 \cdot I_{D25}$, Note 1			50 m Ω

Symbol	Test Conditions ($T_J = 25^\circ\text{C}$, Unless Otherwise Specified)	Characteristic Values		
		Min.	Typ.	Max.
g_{fs}	$V_{DS} = -10\text{V}$, $I_D = 0.5 \cdot I_{D25}$, Note 1	12	20	S
C_{iss}	$V_{GS} = 0\text{V}$, $V_{DS} = -25\text{V}$, $f = 1\text{MHz}$		2845	pF
C_{oss}			1015	pF
C_{rss}			275	pF
$t_{d(on)}$	Resistive Switching Times $V_{GS} = -10\text{V}$, $V_{DS} = 0.5 \cdot V_{DSS}$, $I_D = 0.5 \cdot I_{D25}$ $R_G = 3.3\Omega$ (External)		22	ns
t_r			29	ns
$t_{d(off)}$			38	ns
t_f			22	ns
$Q_{g(on)}$	$V_{GS} = -10\text{V}$, $V_{DS} = 0.5 \cdot V_{DSS}$, $I_D = 0.5 \cdot I_{D25}$		60	nC
Q_{gs}			17	nC
Q_{gd}			23	nC
R_{thJC}			0.42	$^\circ\text{C/W}$
R_{thCS}	(TO-3P)(TO-247)		0.21	$^\circ\text{C/W}$
	(TO-220)		0.50	$^\circ\text{C/W}$

Source-Drain Diode

Symbol	Test Conditions ($T_J = 25^\circ\text{C}$, Unless Otherwise Specified)	Characteristic Values		
		Min.	Typ.	Max.
I_S	$V_{GS} = 0\text{V}$			- 52 A
I_{SM}	Repetitive, Pulse Width Limited by T_{JM}			- 200 A
V_{SD}	$I_F = -26\text{A}$, $V_{GS} = 0\text{V}$, Note 1			- 3.5 V
t_{rr}	$I_F = -26\text{A}$, $-di/dt = -100\text{A}/\mu\text{s}$ $V_R = -50\text{V}$, $V_{GS} = 0\text{V}$		120	ns
Q_{RM}			0.53	μC
I_{RM}			- 8.9	A

Note 1: Pulse test, $t \leq 300\mu\text{s}$, duty cycle, $d \leq 2\%$.

IXYS Reserves the Right to Change Limits, Test Conditions, and Dimensions.

IXYS MOSFETs and IGBTs are covered by one or more of the following U.S. patents:

4,835,592	4,931,844	5,049,961	5,237,481	6,162,665	6,404,065 B1	6,683,344	6,727,585	7,005,734 B2	7,157,338B2
4,860,072	5,017,508	5,063,307	5,381,025	6,259,123 B1	6,534,343	6,710,405 B2	6,759,692	7,063,975 B2	
4,881,106	5,034,796	5,187,117	5,486,715	6,306,728 B1	6,583,505	6,710,463	6,771,478 B2	7,071,537	

TO-247 Outline

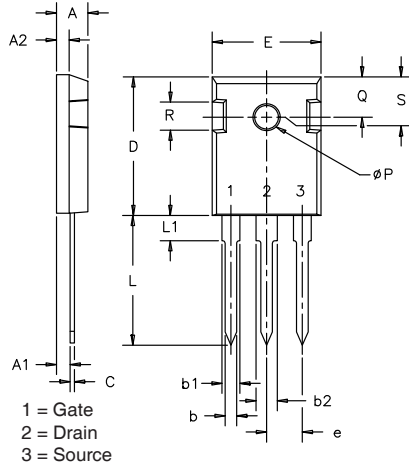

SYM	INCHES		MILLIMETERS	
	MIN	MAX	MIN	MAX
A	.185	.209	4.7	5.3
A1	.087	.102	2.2	2.54
A2	.059	.098	2.2	2.6
b	.040	.055	1.0	1.4
b1	.065	.084	1.65	2.13
b2	.113	.123	2.87	3.12
C	.016	.031	.4	.8
D	.819	.845	20.80	21.46
E	.610	.640	15.75	16.26
e	.215 BSC		5.45 BSC	
L	.780	.800	19.81	20.32
L1	.177		4.50	
∅P	.140	.144	3.55	3.65
Q	.212	.244	5.4	6.2
R	.170	.216	4.32	5.49
S	.242 BSC		6.15 BSC	

TO-220 Outline

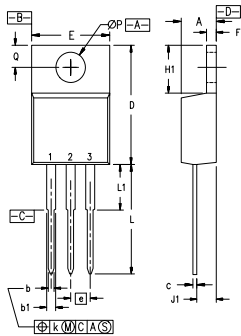

SYM	INCHES		MILLIMETERS	
	MIN	MAX	MIN	MAX
A	.170	.190	4.32	4.83
b	.025	.040	0.64	1.02
b1	.045	.065	1.15	1.65
c	.014	.022	0.35	0.56
D	.580	.630	14.73	16.00
E	.390	.420	9.91	10.66
e	.100 BSC		2.54 BSC	
F	.045	.055	1.14	1.40
H1	.230	.270	5.85	6.85
J1	.090	.110	2.29	2.79
k	0	.015	0	0.38
L	.500	.550	12.70	13.97
L1	.110	.230	2.79	5.84
∅P	.139	.161	3.53	4.08
Q	.100	.125	2.54	3.18

TO-3P Outline

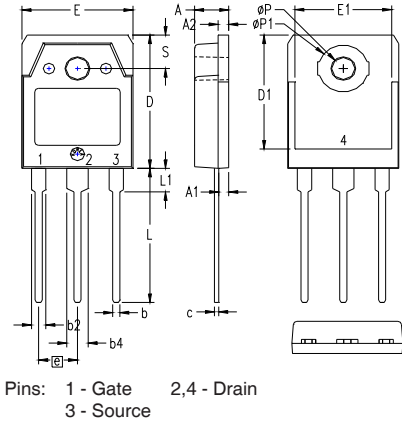

SYM	INCHES		MILLIMETERS	
	MIN	MAX	MIN	MAX
A	.185	.193	4.70	4.90
A1	.051	.059	1.30	1.50
A2	.057	.065	1.45	1.65
b	.035	.045	0.90	1.15
b2	.075	.087	1.90	2.20
b4	.114	.126	2.90	3.20
c	.022	.031	0.55	0.80
D	.780	.791	19.80	20.10
D1	.665	.677	16.90	17.20
E	.610	.622	15.50	15.80
E1	.531	.539	13.50	13.70
e	.215 BSC		5.45 BSC	
L	.779	.795	19.80	20.20
L1	.134	.142	3.40	3.60
∅P	.126	.134	3.20	3.40
∅P1	.272	.280	6.90	7.10
S	.193	.201	4.90	5.10

All metal area are tin plated.

TO-263 Outline

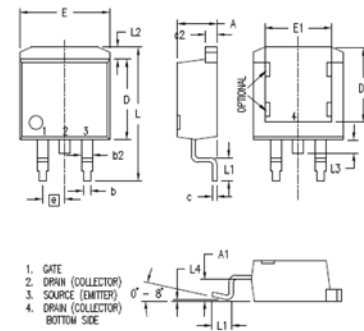

SYM	INCHES		MILLIMETERS	
	MIN	MAX	MIN	MAX
A	.160	.190	4.06	4.83
A1	.080	.110	2.03	2.79
b	.020	.039	0.51	0.99
b2	.045	.055	1.14	1.40
c	.016	.029	0.40	0.74
c2	.045	.055	1.14	1.40
D	.340	.380	8.64	9.65
D1	.315	.350	8.00	8.89
E	.380	.410	9.65	10.41
E1	.245	.320	6.22	8.13
e	.100 BSC		2.54 BSC	
L	.575	.625	14.61	15.88
L1	.090	.110	2.29	2.79
L2	.040	.055	1.02	1.40
L3	.050	.070	1.27	1.78
L4	0	.005	0	0.13

Fig. 1. Output Characteristics @ $T_J = 25^\circ\text{C}$

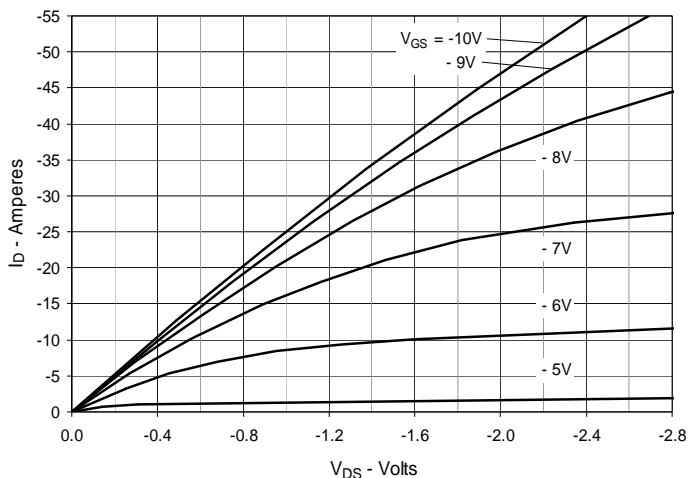

Fig. 2. Extended Output Characteristics @ $T_J = 25^\circ\text{C}$

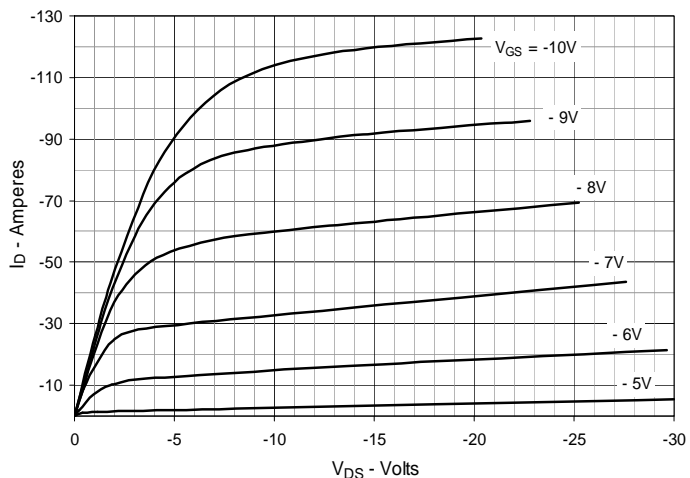

Fig. 3. Output Characteristics @ $T_J = 125^\circ\text{C}$

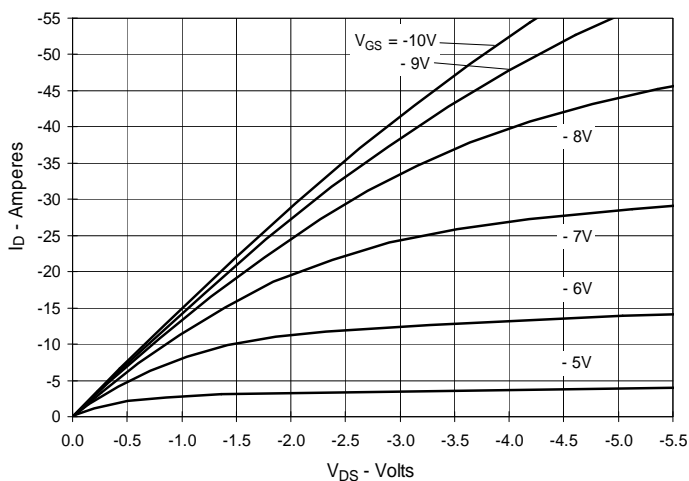

Fig. 4. $R_{DS(on)}$ Normalized to $I_D = -26\text{A}$ Value vs. Junction Temperature

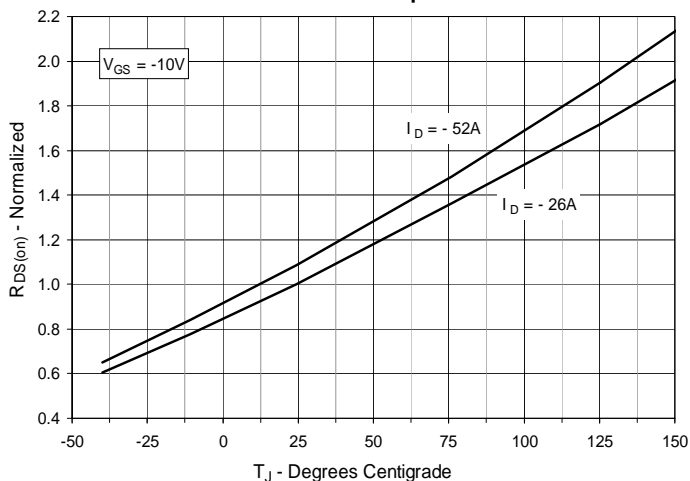

Fig. 5. $R_{DS(on)}$ Normalized to $I_D = -26\text{A}$ Value vs. Drain Current

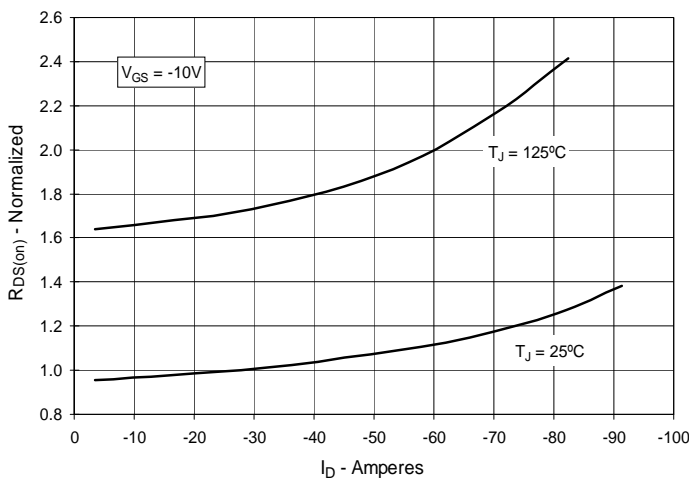

Fig. 6. Maximum Drain Current vs. Case Temperature

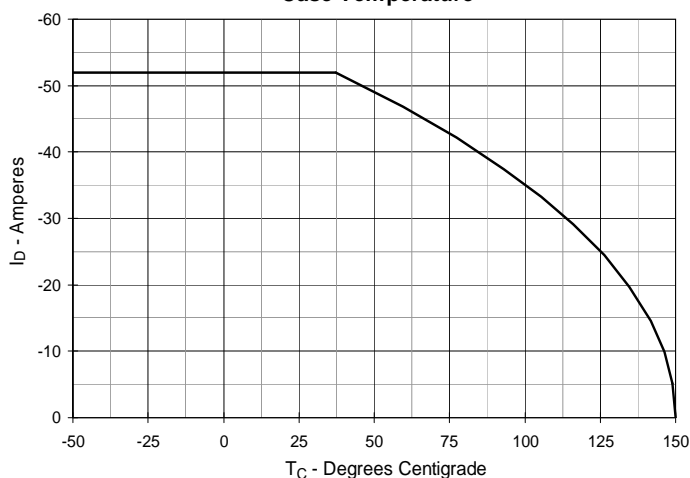

Fig. 7. Input Admittance

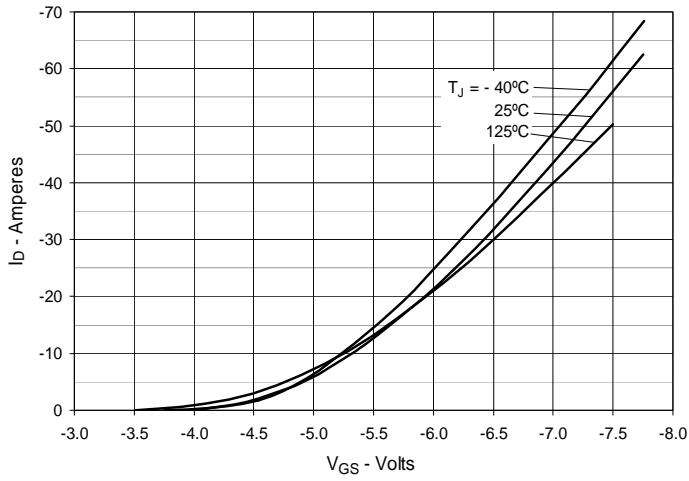

Fig. 8. Transconductance

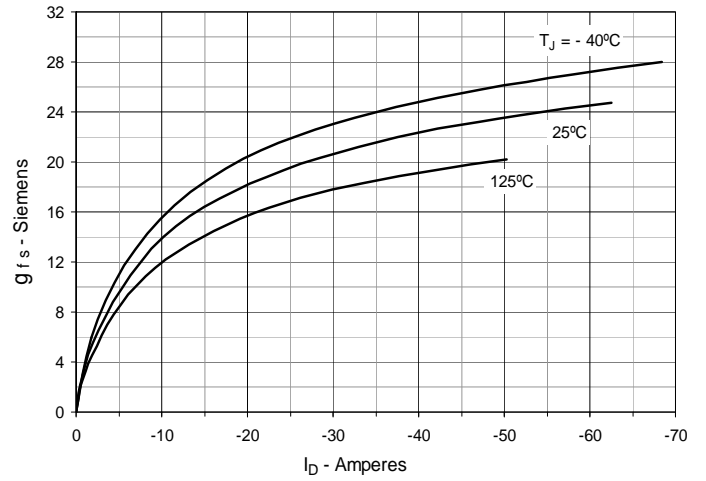

Fig. 9. Forward Voltage Drop of Intrinsic Diode

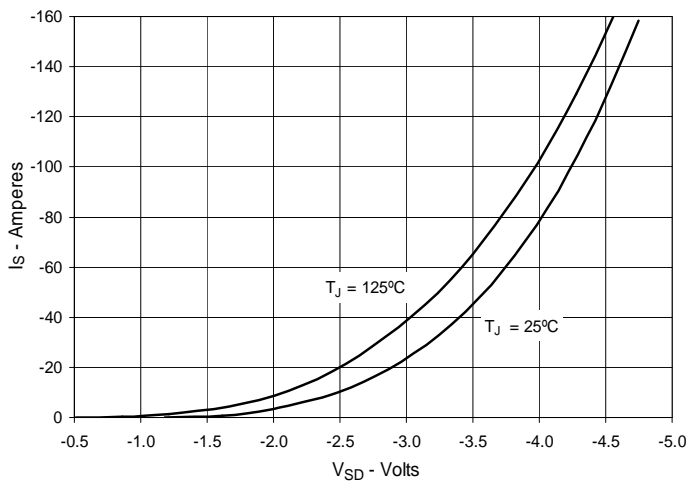

Fig. 10. Gate Charge

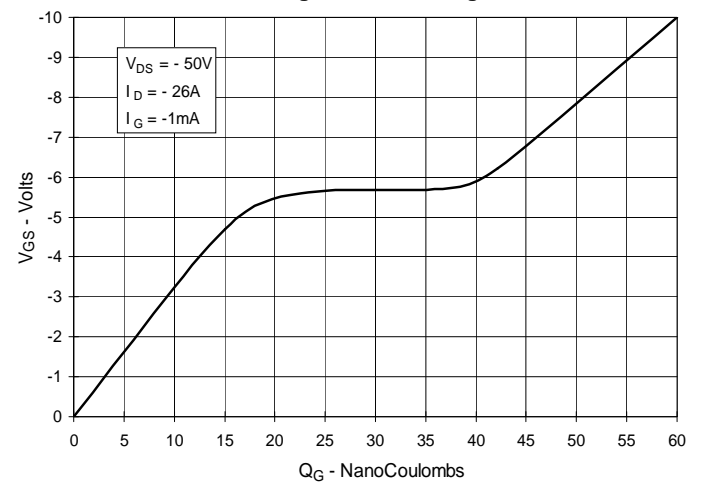

Fig. 11. Capacitance

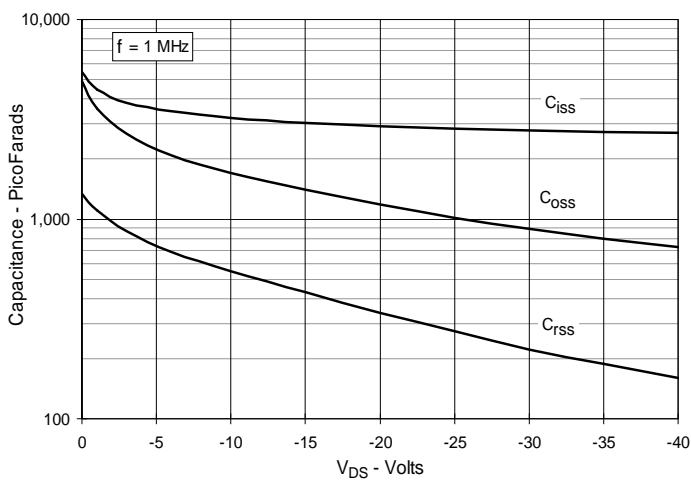

Fig. 12. Forward-Bias Safe Operating Area

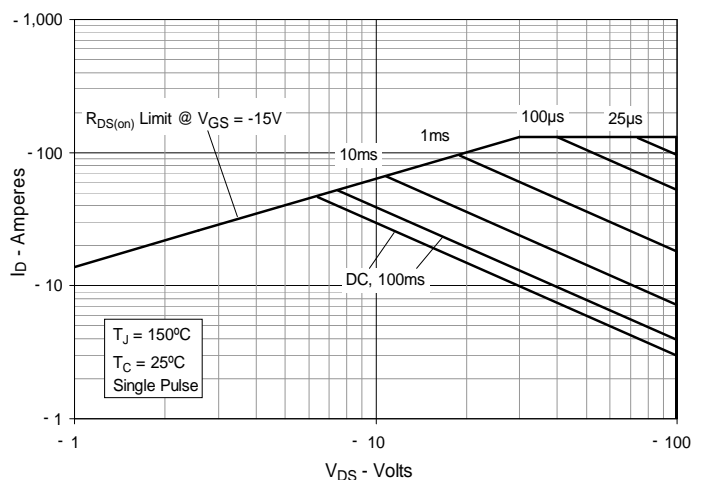
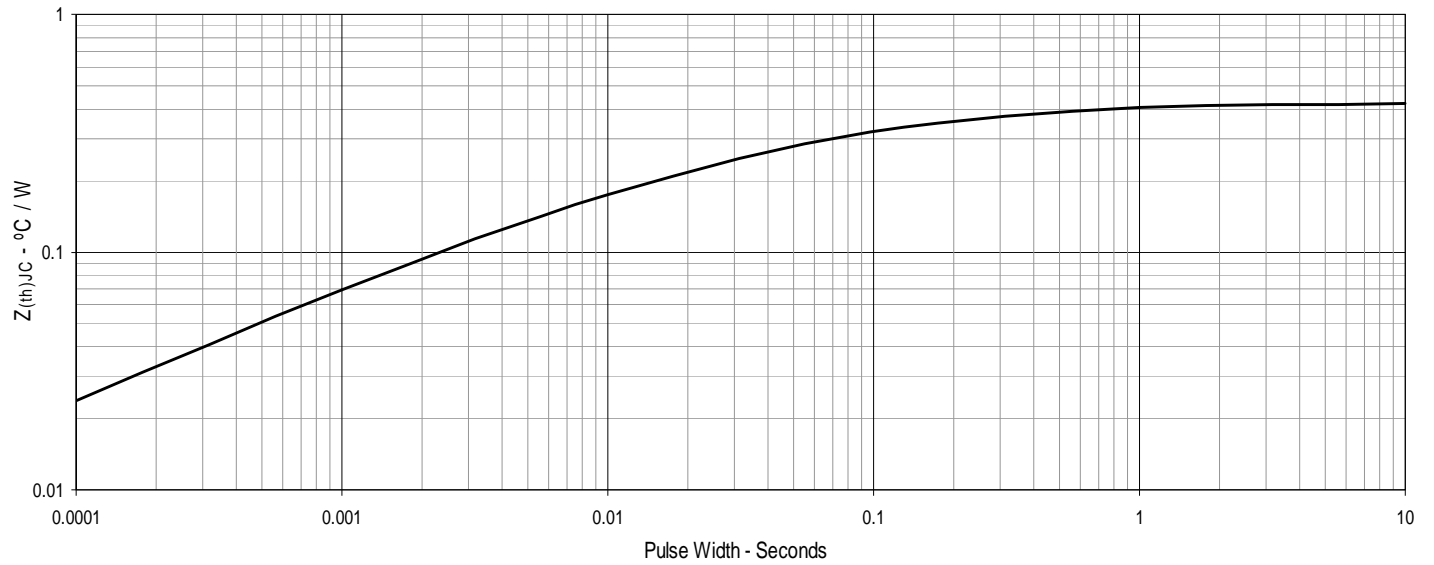

Fig. 13. Maximum Transient Thermal Impedance





Disclaimer Notice - Information furnished is believed to be accurate and reliable. However, users should independently evaluate the suitability of and test each product selected for their own applications. Littelfuse products are not designed for, and may not be used in, all applications. Read complete Disclaimer Notice at www.littelfuse.com/disclaimer-electronics.