

**TrenchP™  
Power MOSFETs**

**IXTT140P10T  
IXTH140P10T**

$V_{DSS} = -100V$   
 $I_{D25} = -140A$   
 $R_{DS(on)} \leq 10m\Omega$

P-Channel Enhancement Mode  
Avalanche Rated

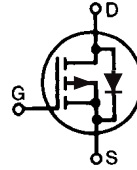

TO-268 (IXTT)

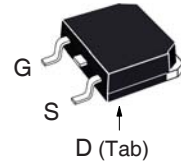

TO-247 (IXTH)

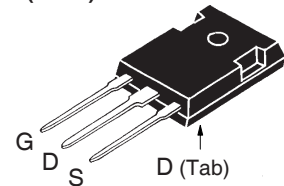

G = Gate      D = Drain  
S = Source    Tab = Drain

Symbol	Test Conditions	Maximum Ratings	
$V_{DSS}$	$T_J = 25^\circ C$ to $150^\circ C$	-100	V
$V_{DGR}$	$T_J = 25^\circ C$ to $150^\circ C$ , $R_{GS} = 1M\Omega$	-100	V
$V_{GSS}$	Continuous	$\pm 15$	V
$V_{GSM}$	Transient	$\pm 25$	V
$I_{D25}$	$T_C = 25^\circ C$	-140	A
$I_{DM}$	$T_C = 25^\circ C$ , Pulse Width Limited by $T_{JM}$	- 400	A
$I_A$	$T_C = 25^\circ C$	-140	A
$E_{AS}$	$T_C = 25^\circ C$	2.5	J
dv/dt	$I_S \leq I_{DM}$ , $V_{DD} \leq V_{DSS}$ , $T_J \leq 150^\circ C$	10	V/ns
$P_D$	$T_C = 25^\circ C$	568	W
$T_J$		- 55 ... +150	$^\circ C$
$T_{JM}$		150	$^\circ C$
$T_{stg}$		- 55 ... +150	$^\circ C$
$T_L$	1.6mm (0.062 in.) from Case for 10s	300	$^\circ C$
$T_{SOLD}$	Plastic Body for 10s	260	$^\circ C$
$M_d$	Mounting Torque (TO-247)	1.13 / 10	Nm/lb.in.
Weight	TO-268	4	g
	TO-247	6	g

**Features**

- International Standard Packages
- Avalanche Rated
- Extended FBSOA
- Fast Intrinsic Diode
- Low  $R_{DS(ON)}$  and  $Q_G$

**Advantages**

- Easy to Mount
- Space Savings
- High Power Density

**Applications**

- High-Side Switching
- Push Pull Amplifiers
- DC Choppers
- Automatic Test Equipment
- Current Regulators
- Battery Charger Applications

Symbol	Test Conditions ( $T_J = 25^\circ C$ , Unless Otherwise Specified)	Characteristic Values		
		Min.	Typ.	Max.
$BV_{DSS}$	$V_{GS} = 0V$ , $I_D = - 250\mu A$	-100		V
$V_{GS(th)}$	$V_{DS} = V_{GS}$ , $I_D = - 250\mu A$	- 2.0		V
$I_{GSS}$	$V_{GS} = \pm 15V$ , $V_{DS} = 0V$			$\pm 100$ nA
$I_{DSS}$	$V_{DS} = V_{DSS}$ , $V_{GS} = 0V$ $T_J = 125^\circ C$			- 10 $\mu A$ -150 $\mu A$
$R_{DS(on)}$	$V_{GS} = -10V$ , $I_D = 0.5 \cdot I_{D25}$ , Note 1			10 m $\Omega$

Symbol	Test Conditions ( $T_J = 25^\circ\text{C}$ , Unless Otherwise Specified)	Characteristic Values		
		Min.	Typ.	Max.
$g_{fs}$	$V_{DS} = -10\text{V}$ , $I_D = 0.5 \cdot I_{D25}$ , Note 1	70	115	S
$C_{iss}$	$V_{GS} = 0\text{V}$ , $V_{DS} = -25\text{V}$ , $f = 1\text{MHz}$		32.8	nF
$C_{oss}$			2290	pF
$C_{rss}$			700	pF
$t_{d(on)}$	<b>Resistive Switching Times</b> $V_{GS} = -10\text{V}$ , $V_{DS} = 0.5 \cdot V_{DSS}$ , $I_D = 0.5 \cdot I_{D25}$ $R_G = 1\Omega$ (External)		58	ns
$t_r$			26	ns
$t_{d(off)}$			86	ns
$t_f$			26	ns
$Q_{g(on)}$	$V_{GS} = -10\text{V}$ , $V_{DS} = 0.5 \cdot V_{DSS}$ , $I_D = 0.5 \cdot I_{D25}$		400	nC
$Q_{gs}$			125	nC
$Q_{gd}$			100	nC
$R_{thJC}$	TO-247			0.22 $^\circ\text{C/W}$
$R_{thCS}$			0.21	$^\circ\text{C/W}$

### Source-Drain Diode

Symbol	Test Conditions ( $T_J = 25^\circ\text{C}$ , Unless Otherwise Specified)	Characteristic Values		
		Min.	Typ.	Max.
$I_S$	$V_{GS} = 0\text{V}$			-140 A
$I_{SM}$	Repetitive, Pulse Width Limited by $T_{JM}$			-560 A
$V_{SD}$	$I_F = -100\text{A}$ , $V_{GS} = 0\text{V}$ , Note 1			-1.4 V
$t_{rr}$	$I_F = -70\text{A}$ , $-di/dt = -100\text{A}/\mu\text{s}$ $V_R = -100\text{V}$ , $V_{GS} = 0\text{V}$		130	ns
$Q_{RM}$			650	nC
$I_{RM}$			-10	A

Note 1. Pulse test,  $t \leq 300\mu\text{s}$ , duty cycle,  $d \leq 2\%$ .

### TO-268 Outline

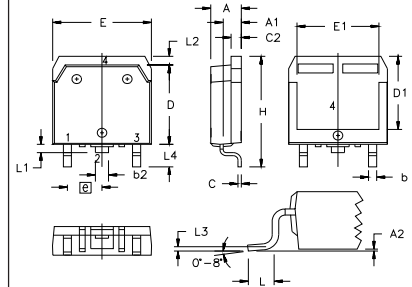

Terminals: 1 - Gate, 2,4 - Drain, 3 - Source

SYM	INCHES		MILLIMETERS	
	MIN	MAX	MIN	MAX
A	.193	.201	4.90	5.10
A1	.106	.114	2.70	2.90
A2	.001	.010	0.02	0.25
b	.045	.057	1.15	1.45
b2	.075	.083	1.90	2.10
C	.016	.026	0.40	0.65
C2	.057	.063	1.45	1.60
D	.543	.551	13.80	14.00
D1	.488	.500	12.40	12.70
E	.624	.632	15.85	16.05
E1	.524	.535	13.30	13.60
e	.215 BSC		5.45 BSC	
H	.736	.752	18.70	19.10
L	.094	.106	2.40	2.70
L1	.047	.055	1.20	1.40
L2	.039	.045	1.00	1.15
L3	.010 BSC		0.25 BSC	
L4	.150	.161	3.80	4.10

### TO-247 Outline

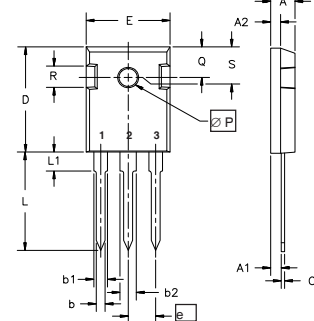

Terminals: 1 - Gate, 2 - Drain, 3 - Source

Dim.	Millimeter		Inches	
	Min.	Max.	Min.	Max.
A	4.7	5.3	.185	.209
A <sub>1</sub>	2.2	2.54	.087	.102
A <sub>2</sub>	2.2	2.6	.059	.098
b	1.0	1.4	.040	.055
b <sub>1</sub>	1.65	2.13	.065	.084
b <sub>2</sub>	2.87	3.12	.113	.123
C	.4	.8	.016	.031
D	20.80	21.46	.819	.845
E	15.75	16.26	.610	.640
e	5.20	5.72	0.205	0.225
L	19.81	20.32	.780	.800
L1		4.50		.177
∅P	3.55	3.65	.140	.144
Q	5.89	6.40	0.232	0.252
R	4.32	5.49	.170	.216
S	6.15 BSC		242 BSC	

IXYS Reserves the Right to Change Limits, Test Conditions, and Dimensions.

IXYS MOSFETs and IGBTs are covered by one or more of the following U.S. patents:

4,835,592	4,931,844	5,049,961	5,237,481	6,162,665	6,404,065 B1	6,683,344	6,727,585	7,005,734 B2	7,157,338B2
4,860,072	5,017,508	5,063,307	5,381,025	6,259,123 B1	6,534,343	6,710,405 B2	6,759,692	7,063,975 B2	
4,881,106	5,034,796	5,187,117	5,486,715	6,306,728 B1	6,583,505	6,710,463	6,771,478 B2	7,071,537	

Fig. 1. Output Characteristics @  $T_J = 25^\circ\text{C}$

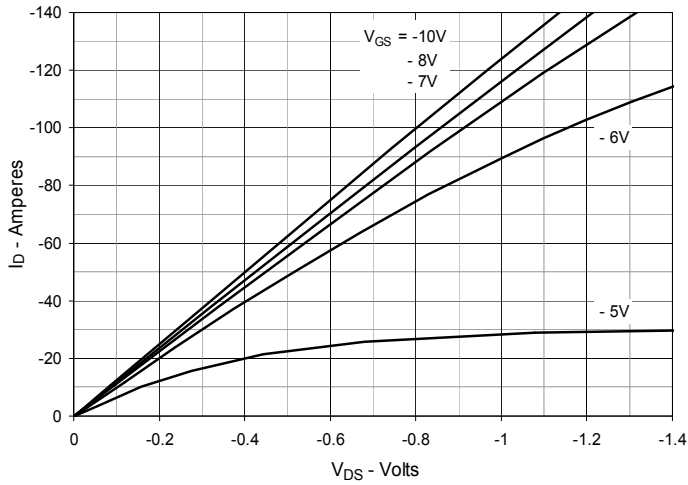

Fig. 2. Extended Output Characteristics @  $T_J = 25^\circ\text{C}$

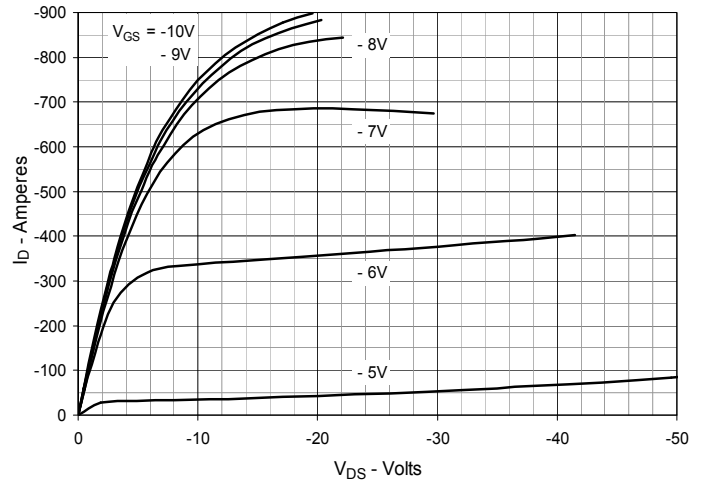

Fig. 3. Output Characteristics @  $T_J = 125^\circ\text{C}$

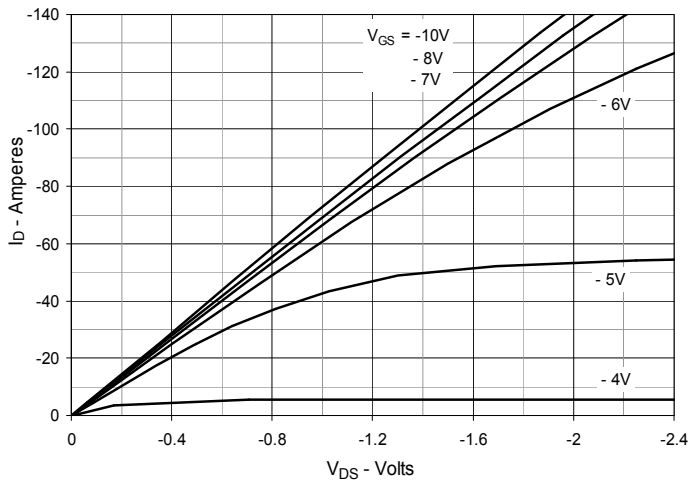

Fig. 4.  $R_{DS(on)}$  Normalized to  $I_D = -70\text{A}$  Value vs. Junction Temperature

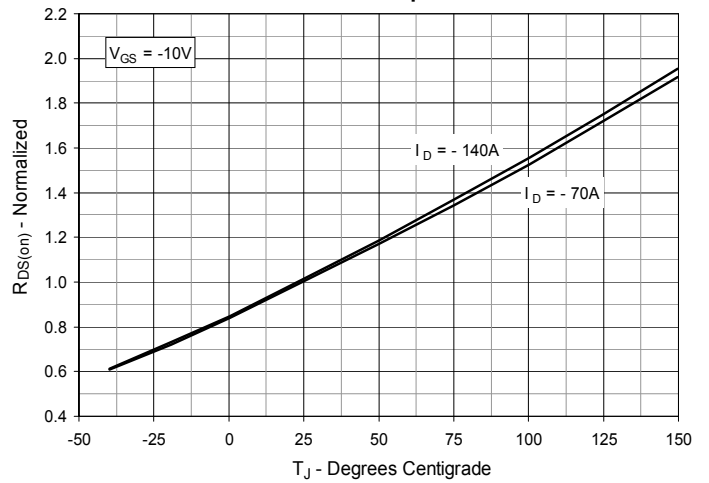

Fig. 5.  $R_{DS(on)}$  Normalized to  $I_D = -70\text{A}$  Value vs. Drain Current

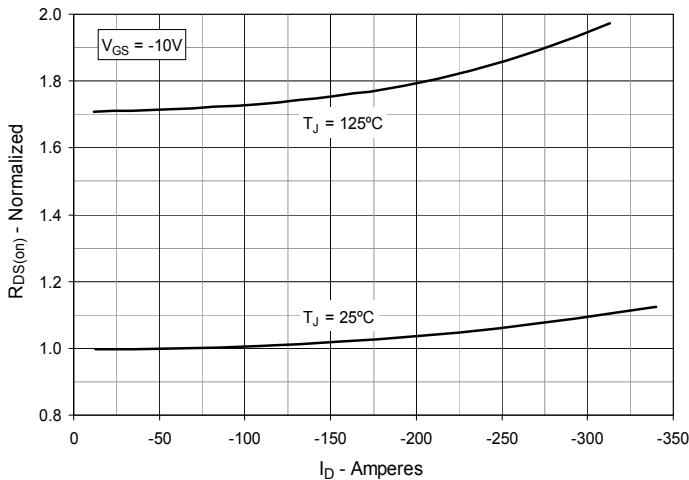
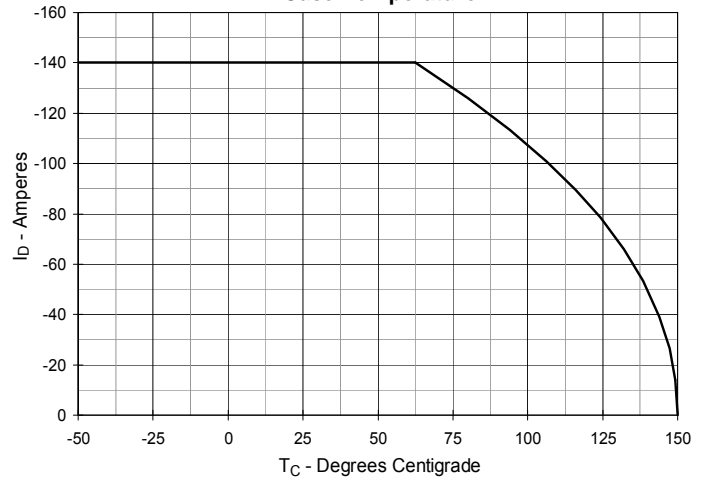
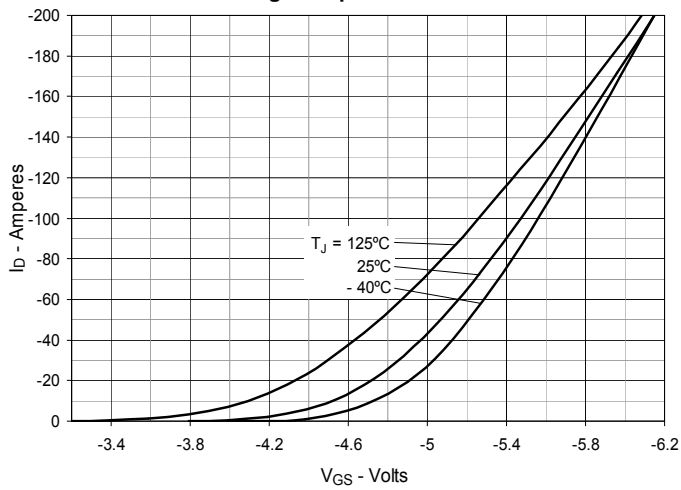

Fig. 6. Maximum Drain Current vs. Case Temperature



**Fig. 7. Input Admittance**



**Fig. 8. Transconductance**

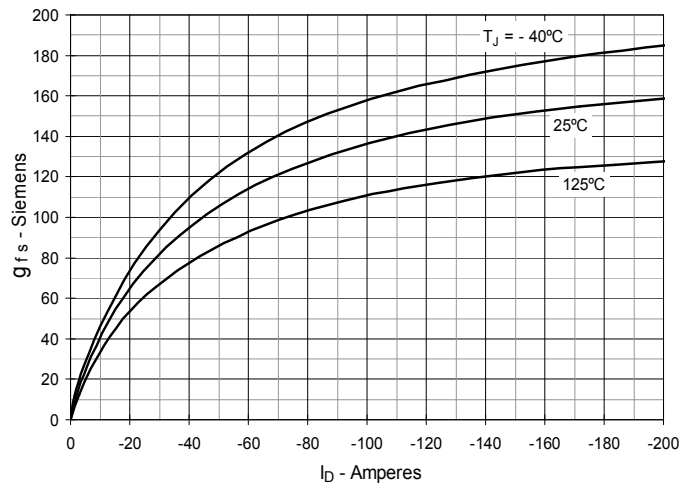

**Fig. 9. Forward Voltage Drop of Intrinsic Diode**

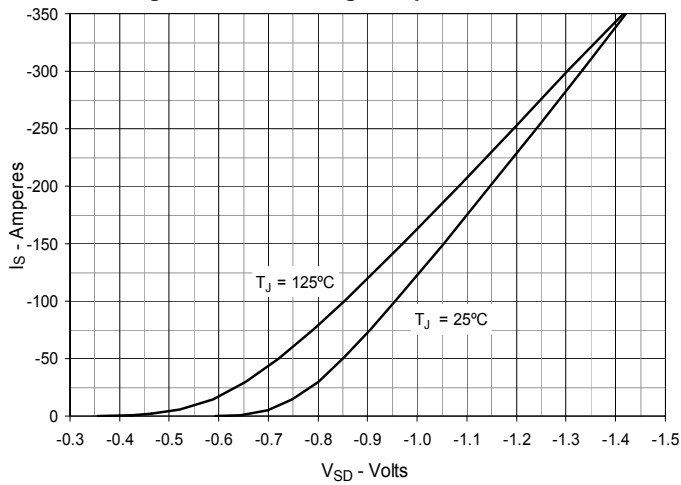

**Fig. 10. Gate Charge**

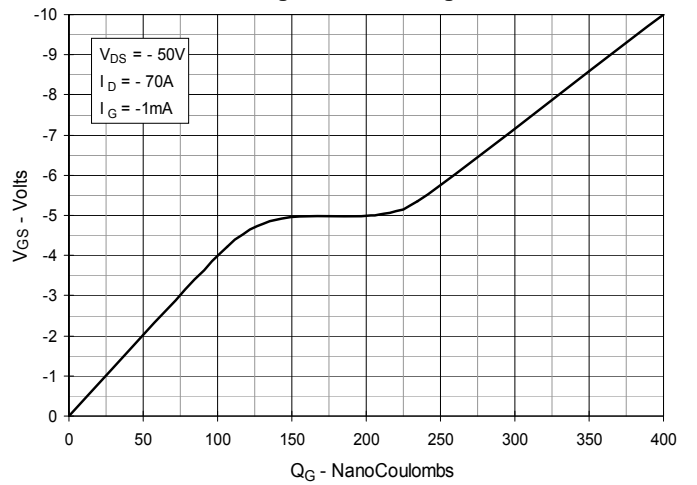

**Fig. 11. Capacitance**

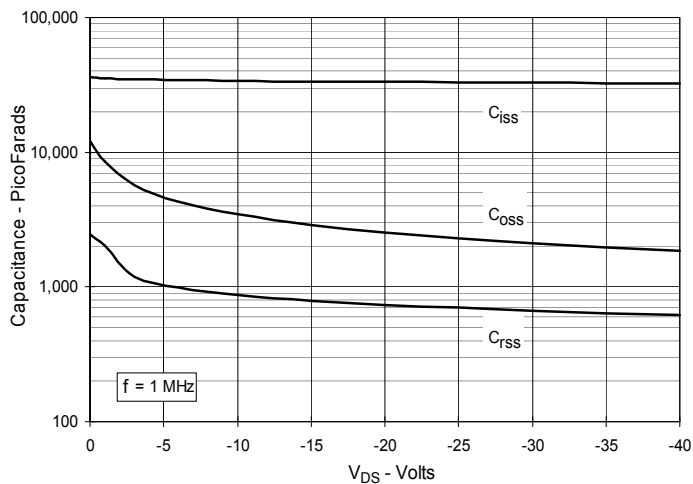

**Fig. 12. Forward-Bias Safe Operating Area**

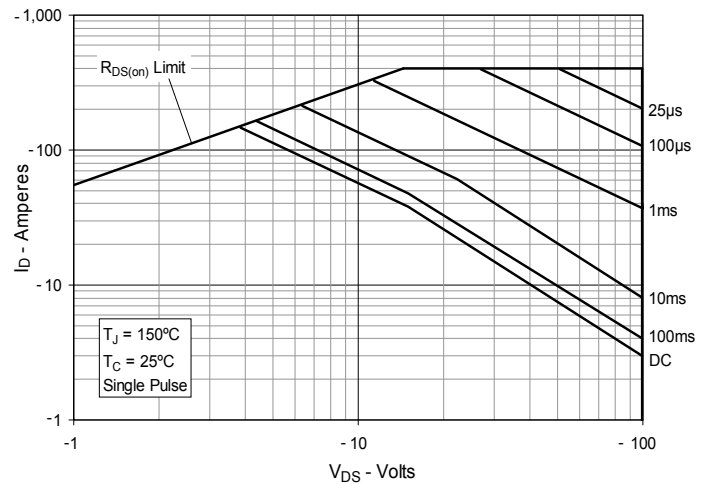

**Fig. 13. Resistive Turn-on Rise Time vs. Junction Temperature**

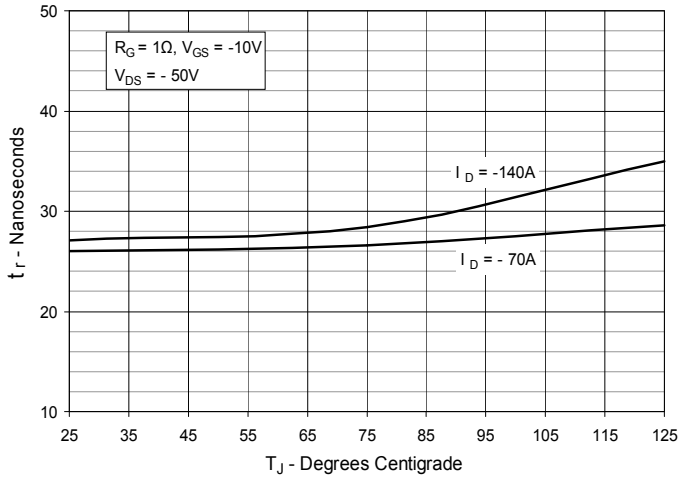

**Fig. 14. Resistive Turn-on Rise Time vs. Drain Current**

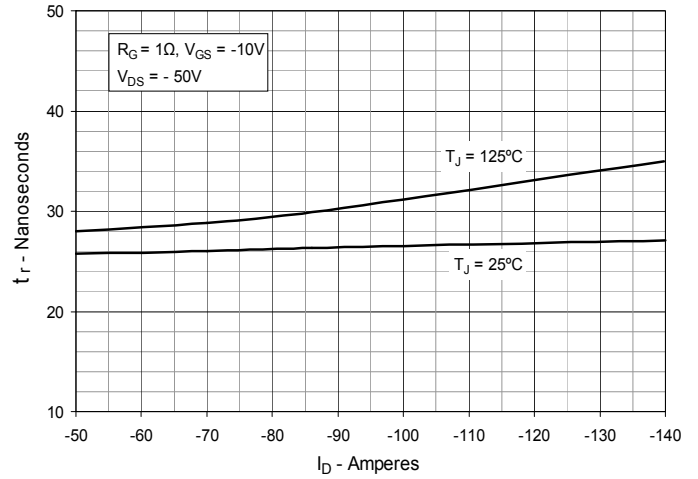

**Fig. 15. Resistive Turn-on Switching Times vs. Gate Resistance**

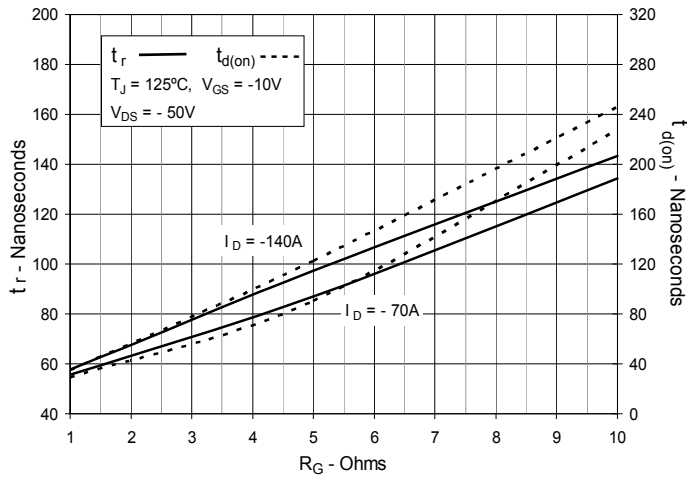

**Fig. 16. Resistive Turn-off Switching Times vs. Junction Temperature**

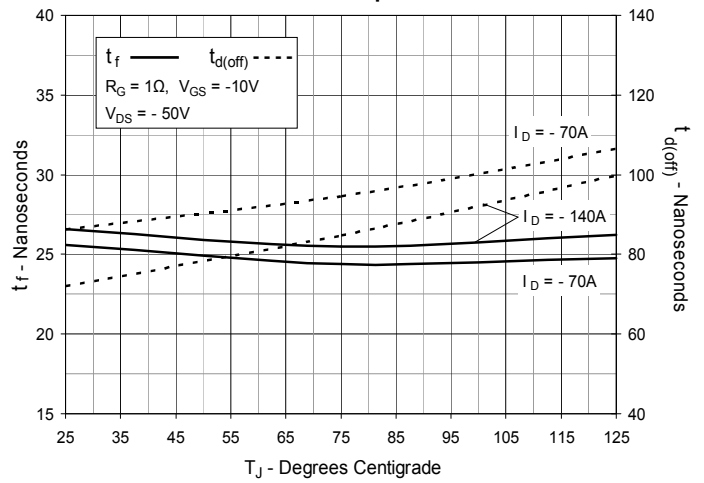

**Fig. 17. Resistive Turn-off Switching Times vs. Drain Current**

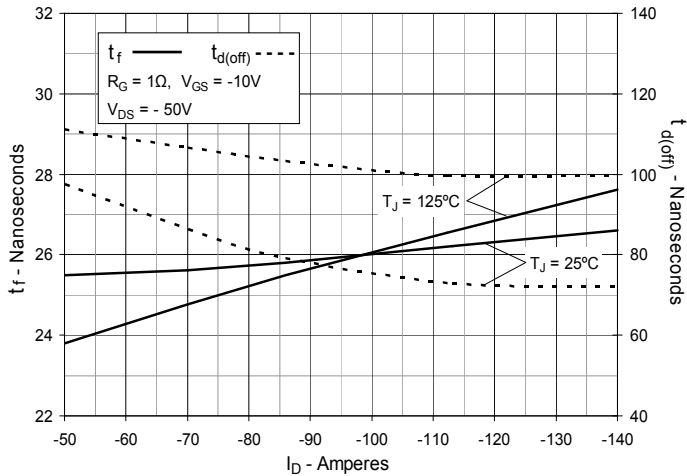

**Fig. 18. Resistive Turn-off Switching Times vs. Gate Resistance**

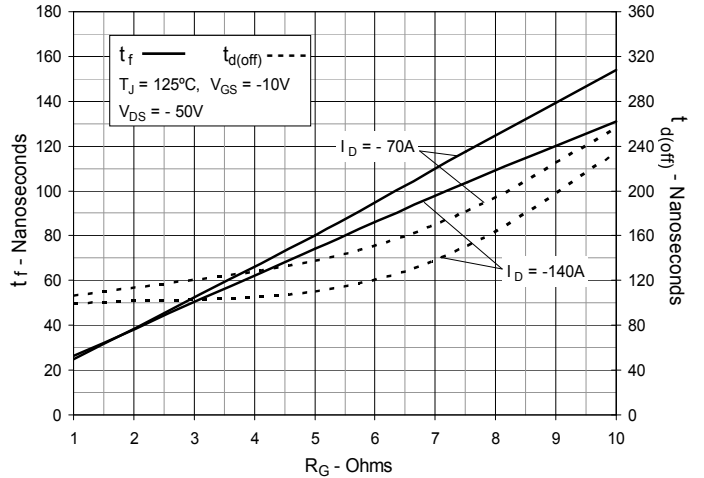
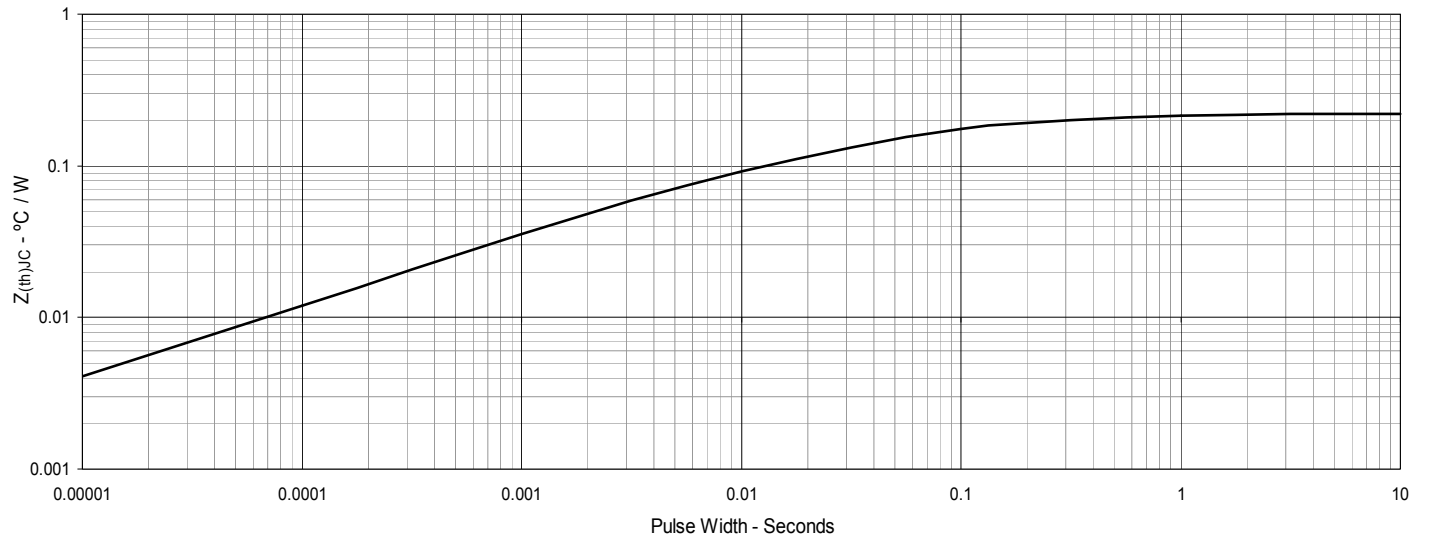

Fig. 19. Maximum Transient Thermal Impedance





---

Disclaimer Notice - Information furnished is believed to be accurate and reliable. However, users should independently evaluate the suitability of and test each product selected for their own applications. Littelfuse products are not designed for, and may not be used in, all applications. Read complete Disclaimer Notice at [www.littelfuse.com/disclaimer-electronics](http://www.littelfuse.com/disclaimer-electronics).