

X4-Class Power MOSFET™

IXTN400N15X4

$V_{DSS} = 150V$
 $I_{D25} = 400A$
 $R_{DS(on)} \leq 2.35m\Omega$

N-Channel Enhancement Mode
Avalanche Rated

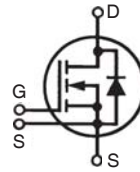

miniBLOC, SOT-227
 E153432

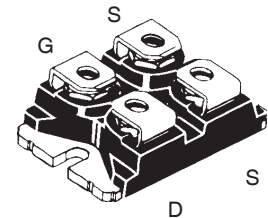

G = Gate D = Drain
S = Source

| Symbol | Test Conditions | Maximum Ratings | |
|--------------|--|-----------------|------------|
| V_{DSS} | $T_J = 25^\circ C$ to $175^\circ C$ | 150 | V |
| V_{DGR} | $T_J = 25^\circ C$ to $175^\circ C$, $R_{GS} = 1M\Omega$ | 150 | V |
| V_{GSS} | Continuous | ± 20 | V |
| V_{GSM} | Transient | ± 30 | V |
| I_{D25} | $T_C = 25^\circ C$ (Chip Capability) | 400 | A |
| $I_{L(RMS)}$ | External Lead Current Limit | 200 | A |
| I_{DM} | $T_C = 25^\circ C$, Pulse Width Limited by T_{JM} | 900 | A |
| I_A | $T_C = 25^\circ C$ | 200 | A |
| E_{AS} | $T_C = 25^\circ C$ | 3 | J |
| P_D | $T_C = 25^\circ C$ | 830 | W |
| dv/dt | $I_S \leq I_{DM}$, $V_{DD} \leq V_{DSS}$, $T_J \leq 150^\circ C$ | 50 | V/ns |
| T_J | | -55 ... +175 | $^\circ C$ |
| T_{JM} | | 175 | $^\circ C$ |
| T_{stg} | | -55 ... +175 | $^\circ C$ |
| V_{ISOL} | 50/60 Hz, RMS $t = 1$ minute | 2500 | V~ |
| | $I_{ISOL} \leq 1mA$ $t = 1$ second | 3000 | V~ |
| M_d | Mounting Torque | 1.5/13 | Nm/lb.in |
| | Terminal Connection Torque | 1.3/11.5 | Nm/lb.in |
| Weight | | 30 | g |

Features

- International Standard Package
- miniBLOC, with Aluminium Nitride Isolation
- Isolation Voltage 2500 V~
- High Current Handling Capability
- Low Q_G
- Avalanche Rated
- Low Package Inductance

Advantages

- High Power Density
- Easy to Mount
- Space Savings

Applications

- Switch-Mode and Resonant-Mode Power Supplies
- DC-DC Converters
- PFC Circuits
- AC and DC Motor Drives
- Robotics and Servo Controls

| Symbol | Test Conditions ($T_J = 25^\circ C$ Unless Otherwise Specified) | Characteristic Values | | |
|--------------|---|-----------------------|------|--------------------|
| | | Min. | Typ. | Max. |
| BV_{DSS} | $V_{GS} = 0V$, $I_D = 1mA$ | 150 | | V |
| $V_{GS(th)}$ | $V_{DS} = V_{GS}$, $I_D = 1mA$ | 2.5 | | 4.5 V |
| I_{GSS} | $V_{GS} = \pm 20V$, $V_{DS} = 0V$ | | | ± 200 nA |
| I_{DSS} | $V_{DS} = V_{DSS}$, $V_{GS} = 0V$ $T_J = 150^\circ C$ | | | 25 μA 2 mA |
| $R_{DS(on)}$ | $V_{GS} = 10V$, $I_D = 100A$, Note 1 | | | 2.35 m Ω |

| Symbol | Test Conditions ($T_J = 25^\circ\text{C}$, Unless Otherwise Specified) | Characteristic Values | | |
|-------------------------------------|--|--|------|-------------------------|
| | | Min. | Typ. | Max |
| g_{fs} | $V_{DS} = 10\text{V}$, $I_D = 60\text{A}$, Note 1 | 100 | 170 | S |
| R_{Gi} | Gate Input Resistance | | 1.2 | Ω |
| C_{iss} | $V_{GS} = 0\text{V}$, $V_{DS} = 25\text{V}$, $f = 1\text{MHz}$ | | 14.5 | nF |
| C_{oss} | | | 3.1 | nF |
| C_{rss} | | | 8.0 | pF |
| Effective Output Capacitance | | | | |
| $C_{o(er)}$ | Energy related | $V_{GS} = 0\text{V}$ $V_{DS} = 0.8 \cdot V_{DSS}$ | 2500 | pF |
| $C_{o(tr)}$ | Time related | | 9400 | pF |
| $t_{d(on)}$ | Resistive Switching Times $V_{GS} = 10\text{V}$, $V_{DS} = 0.5 \cdot V_{DSS}$, $I_D = 0.5 \cdot I_{D25}$ $R_G = 1\Omega$ (External) | | 40 | ns |
| t_r | | | 22 | ns |
| $t_{d(off)}$ | | | 180 | ns |
| t_f | | | 8 | ns |
| $Q_{g(on)}$ | $V_{GS} = 10\text{V}$, $V_{DS} = 0.5 \cdot V_{DSS}$, $I_D = 0.5 \cdot I_{D25}$ | | 430 | nC |
| Q_{gs} | | | 100 | nC |
| Q_{gd} | | | 100 | nC |
| R_{thJC} | | | | 0.18 $^\circ\text{C/W}$ |
| R_{thCS} | | 0.05 | | $^\circ\text{C/W}$ |

Source-Drain Diode

| Symbol | Test Conditions ($T_J = 25^\circ\text{C}$, Unless Otherwise Specified) | Characteristic Values | | |
|----------|--|-----------------------|------|---------------|
| | | Min. | Typ. | Max. |
| I_S | $V_{GS} = 0\text{V}$ | | | 400 A |
| I_{SM} | Repetitive, Pulse Width Limited by T_{JM} | | | 1600 A |
| V_{SD} | $I_F = 100\text{A}$, $V_{GS} = 0\text{V}$, Note 1 | | | 1.4 V |
| t_{rr} | $I_F = 150\text{A}$, $-di/dt = 100\text{A}/\mu\text{s}$ $V_R = 100\text{V}$, $V_{GS} = 0\text{V}$ | | 175 | ns |
| Q_{RM} | | | 1.1 | μC |
| I_{RM} | | | 12.3 | A |

Note 1. Pulse test, $t \leq 300\mu\text{s}$, duty cycle, $d \leq 2\%$.

IXYS Reserves the Right to Change Limits, Test Conditions, and Dimensions.

IXYS MOSFETs and IGBTs are covered by one or more of the following U.S. patents:

| | | | | | | | | | |
|-----------|-----------|-----------|-----------|--------------|--------------|--------------|--------------|--------------|-------------|
| 4,835,592 | 4,931,844 | 5,049,961 | 5,237,481 | 6,162,665 | 6,404,065 B1 | 6,683,344 | 6,727,585 | 7,005,734 B2 | 7,157,338B2 |
| 4,860,072 | 5,017,508 | 5,063,307 | 5,381,025 | 6,259,123 B1 | 6,534,343 | 6,710,405 B2 | 6,759,692 | 7,063,975 B2 | |
| 4,881,106 | 5,034,796 | 5,187,117 | 5,486,715 | 6,306,728 B1 | 6,583,505 | 6,710,463 | 6,771,478 B2 | 7,071,537 | |

Fig. 1. Output Characteristics @ $T_J = 25^\circ\text{C}$

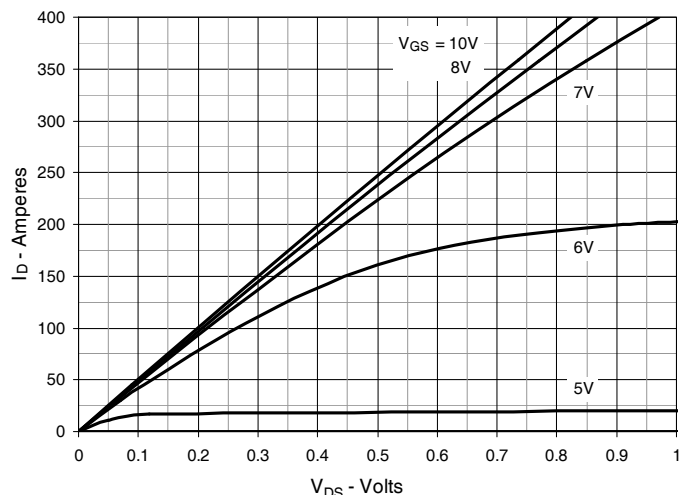

Fig. 2. Extended Output Characteristics @ $T_J = 25^\circ\text{C}$

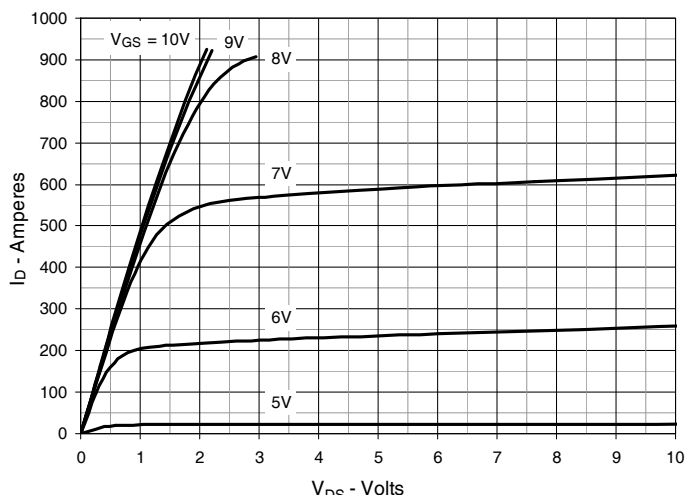

Fig. 3. Output Characteristics @ $T_J = 150^\circ\text{C}$

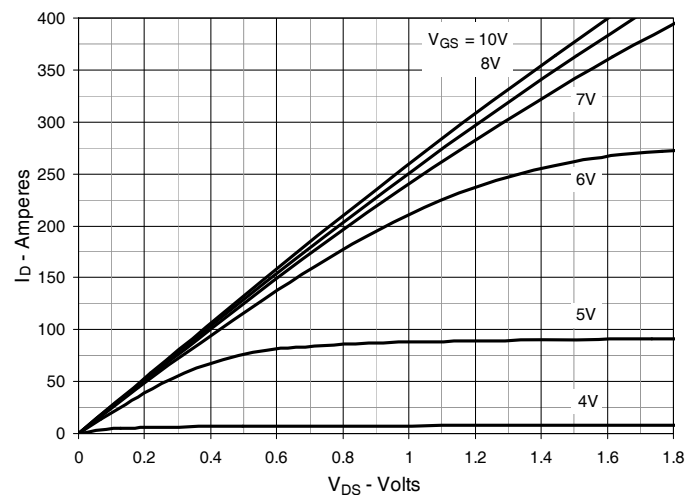

Fig. 4. $R_{DS(on)}$ Normalized to $I_D = 200\text{A}$ Value vs. Junction Temperature

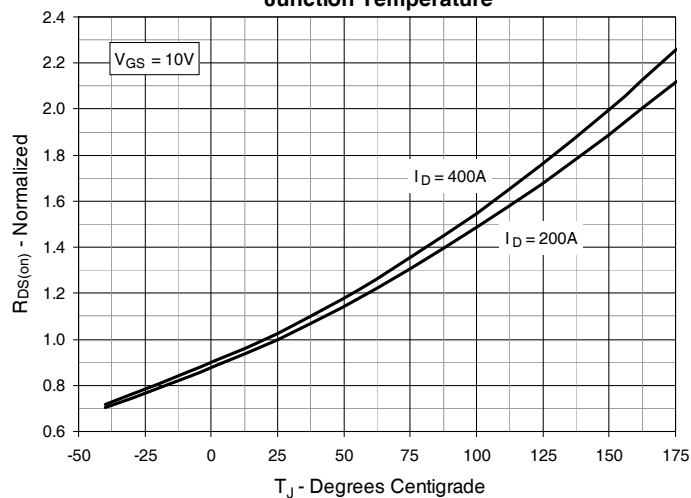

Fig. 5. $R_{DS(on)}$ Normalized to $I_D = 200\text{A}$ Value vs. Drain Current

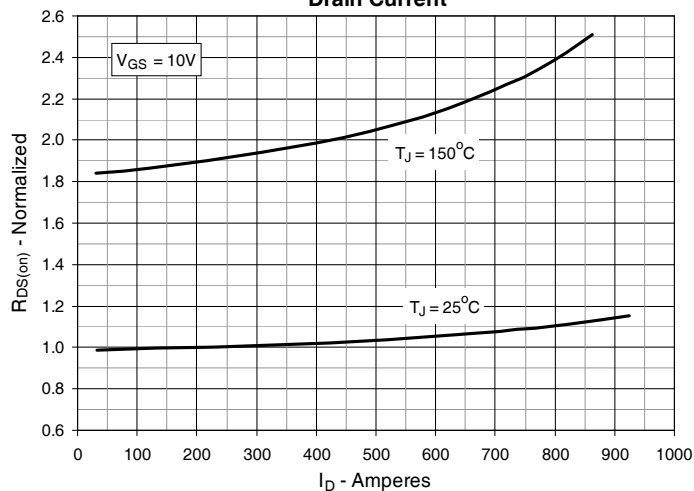

Fig. 6. Normalized Breakdown & Threshold Voltages vs. Junction Temperature

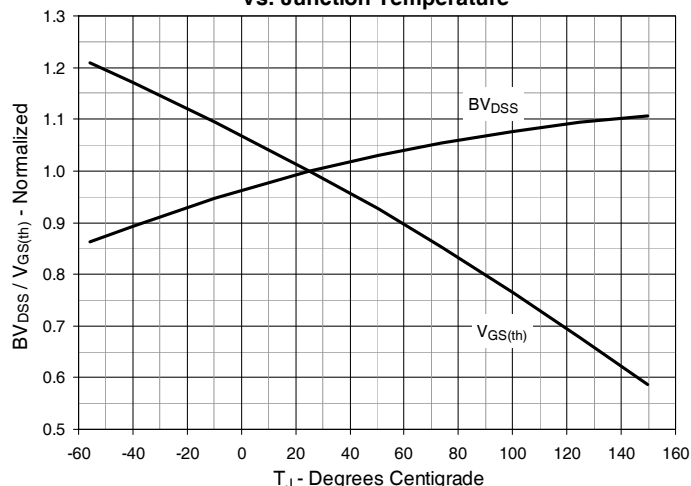

Fig. 7. Maximum Drain Current vs. Case Temperature

Fig. 8. Input Admittance

Fig. 9. Transconductance

Fig. 10. Forward Voltage Drop of Intrinsic Diode

Fig. 11. Gate Charge

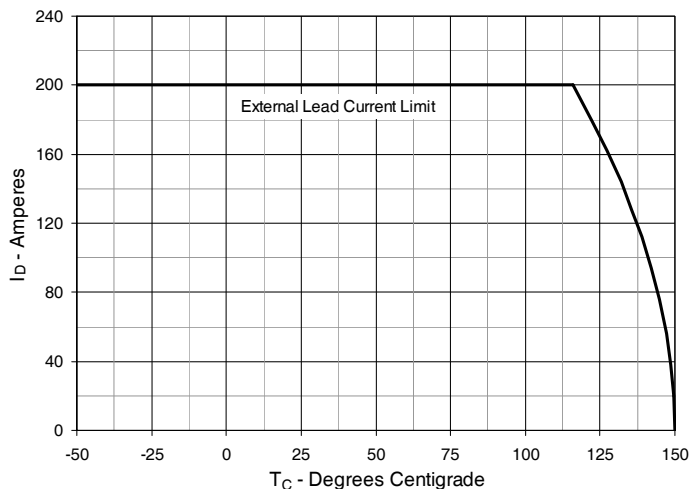
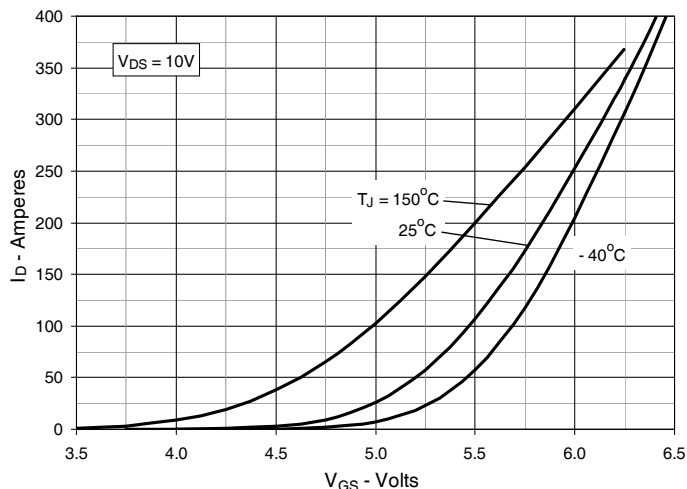
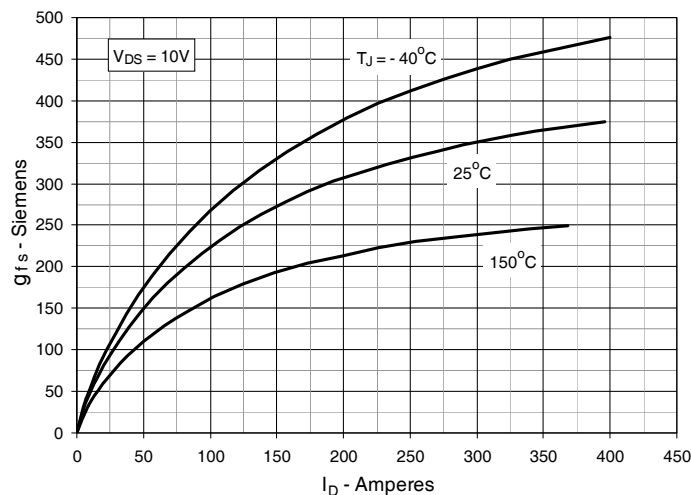
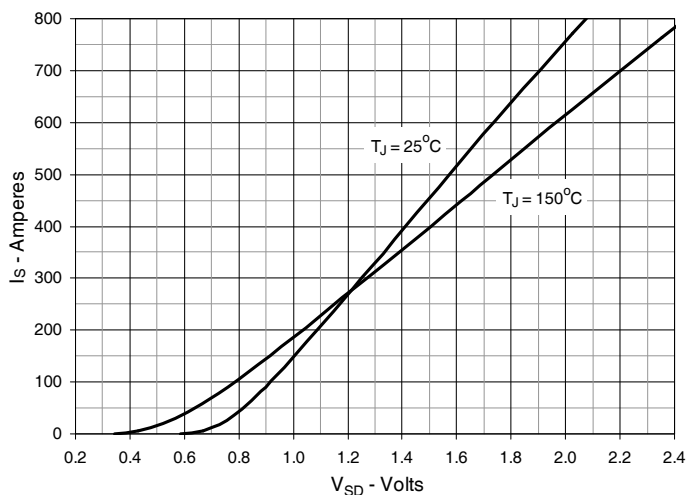
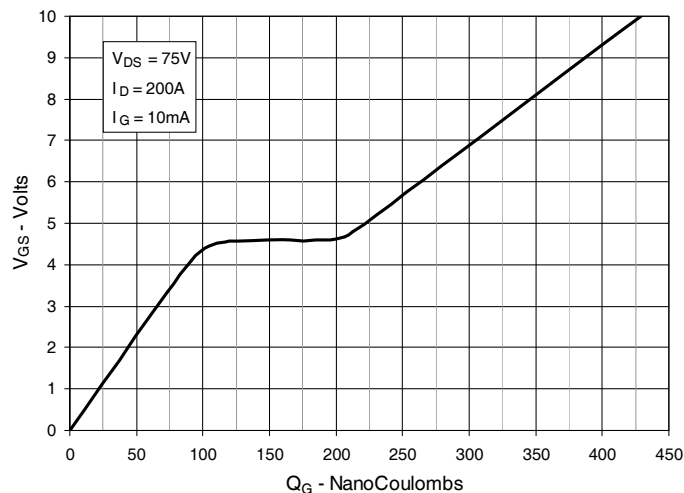
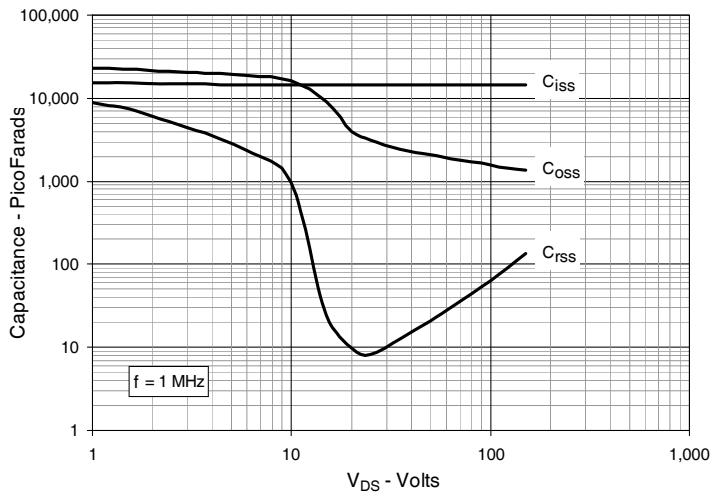
Fig. 12. Capacitance

Fig. 13. Output Capacitance Stored Energy

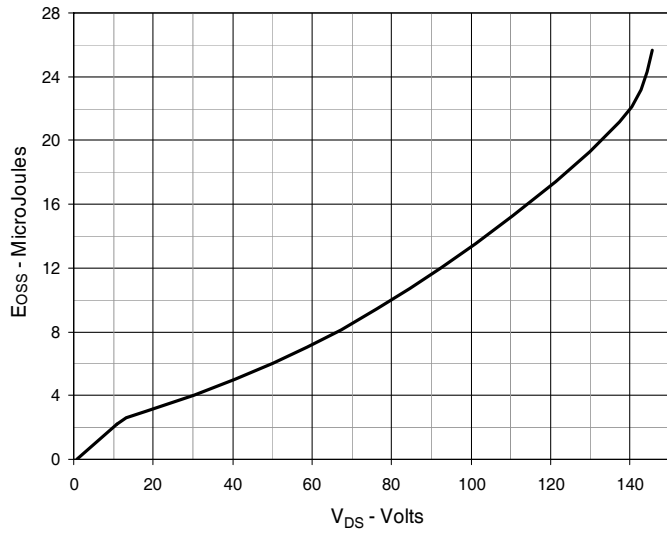

Fig. 14. Forward-Bias Safe Operating Area

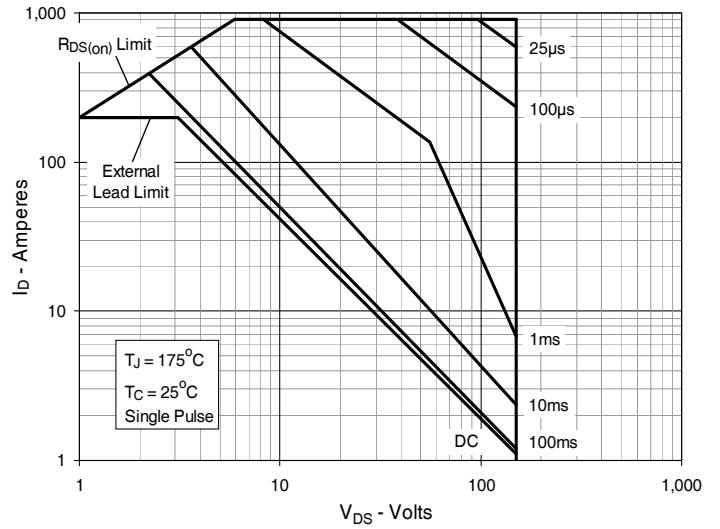
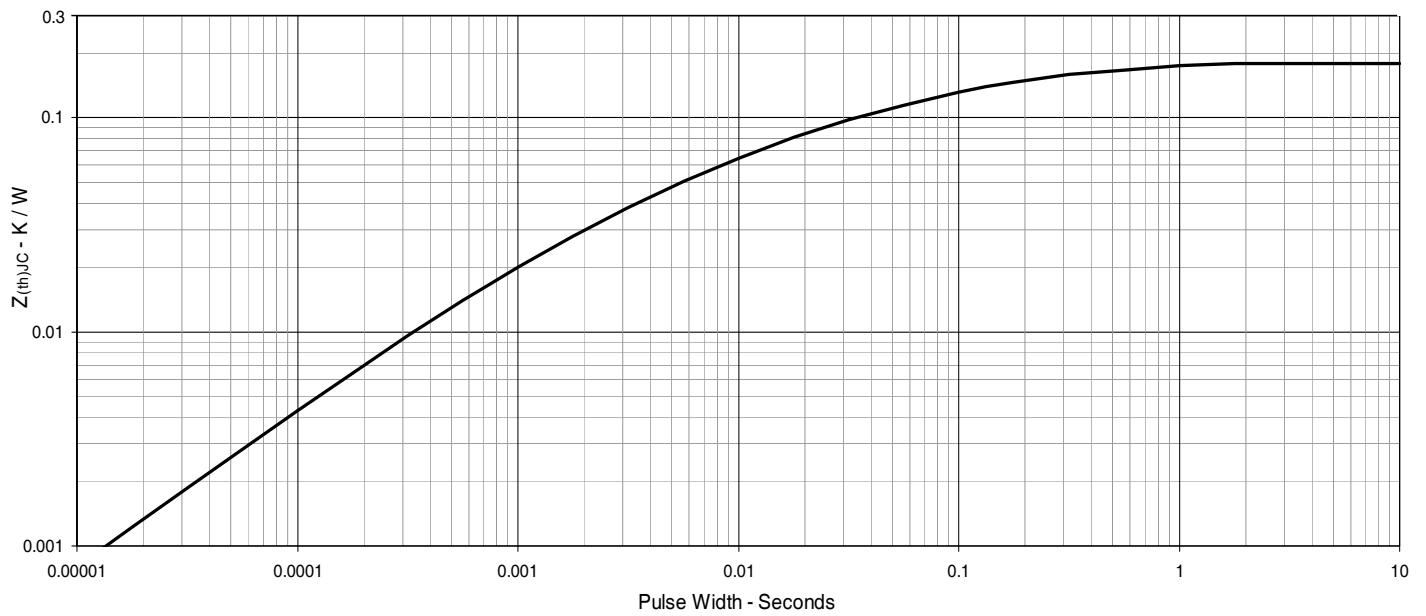
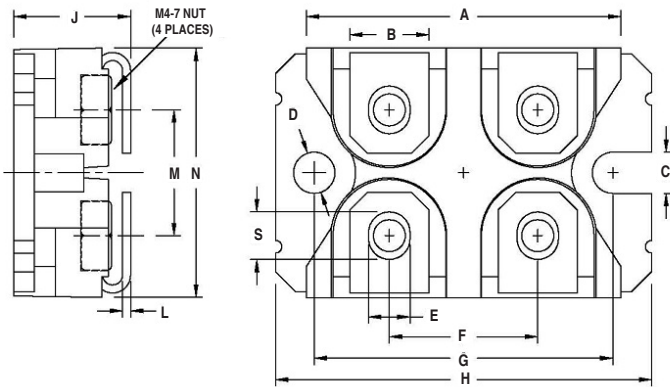
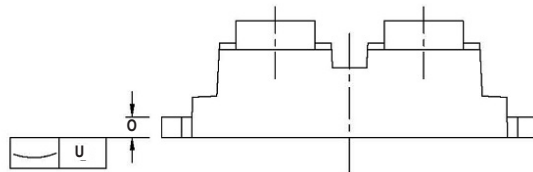

Fig. 15. Maximum Transient Thermal Impedance



SOT-227 Outline

| SYM | INCHES | | MILLIMETERS | |
|-----|--------|-------|-------------|-------|
| | MIN | MAX | MIN | MAX |
| A | 1.224 | 1.260 | 31.10 | 32.00 |
| B | .303 | .327 | 7.70 | 8.30 |
| C | .161 | .173 | 4.10 | 4.40 |
| D | .161 | .173 | 4.10 | 4.40 |
| E | .161 | .173 | 4.10 | 4.40 |
| F | .587 | .598 | 14.90 | 15.20 |
| G | 1.181 | 1.201 | 30.00 | 30.50 |
| H | 1.488 | 1.508 | 37.80 | 38.30 |
| J | .461 | .484 | 11.70 | 12.30 |
| L | .030 | .033 | 0.75 | 0.85 |
| M | .492 | .512 | 12.50 | 13.00 |
| N | .984 | 1.004 | 25.00 | 25.50 |
| O | .075 | .087 | 1.90 | 2.20 |
| S | .181 | .193 | 4.60 | 4.90 |
| U | .000 | .005 | 0.00 | 0.13 |



- NUT MATERIAL:
 STANDARD - Low carbon steel with Ni plating.
 OPTIONAL: - Brass Nut is available.
 PART NUMBER-BN
- ALL METAL SURFACE ARE PRE NI PLATED EXCEPT TRIM AREA.



Disclaimer Notice - Information furnished is believed to be accurate and reliable. However, users should independently evaluate the suitability of and test each product selected for their own applications. Littelfuse products are not designed for, and may not be used in, all applications. Read complete Disclaimer Notice at www.littelfuse.com/disclaimer-electronics.
