

**X2-Class  
Power MOSFET**

N-Channel Enhancement Mode

**IXTU4N70X2  
IXTY4N70X2  
IXTA4N70X2  
IXTP4N70X2**

Symbol	Test Conditions	Maximum Ratings	
$V_{DSS}$	$T_J = 25^\circ\text{C}$ to $150^\circ\text{C}$	700	V
$V_{DGR}$	$T_J = 25^\circ\text{C}$ to $150^\circ\text{C}$ , $R_{GS} = 1\text{M}\Omega$	700	V
$V_{GSS}$	Continuous	$\pm 30$	V
$V_{GSM}$	Transient	$\pm 40$	V
$I_{D25}$	$T_C = 25^\circ\text{C}$	4	A
$I_{DM}$	$T_C = 25^\circ\text{C}$ , Pulse Width Limited by $T_{JM}$	8	A
$I_A$	$T_C = 25^\circ\text{C}$	2	A
$E_{AS}$	$T_C = 25^\circ\text{C}$	150	mJ
$dv/dt$	$I_S \leq I_{DM}$ , $V_{DD} \leq V_{DSS}$ , $T_J \leq 150^\circ\text{C}$	50	V/ns
$P_D$	$T_C = 25^\circ\text{C}$	80	W
$T_J$		-55 ... +150	$^\circ\text{C}$
$T_{JM}$		150	$^\circ\text{C}$
$T_{stg}$		-55 ... +150	$^\circ\text{C}$
$T_L$	Maximum Lead Temperature for Soldering	300	$^\circ\text{C}$
$T_{SOLD}$	1.6 mm (0.062in.) from Case for 10s	260	$^\circ\text{C}$
$F_C$	Mounting Force (TO-263 & TO-251)	10..65 / 2.2..14.6	N/lb
$M_d$	Mounting Torque (TO-220)	1.13 / 10	Nm/lb.in
<b>Weight</b>	TO-251	0.40	g
	TO-252	0.35	g
	TO-263	2.50	g
	TO-220	3.00	g

Symbol	Test Conditions ( $T_J = 25^\circ\text{C}$ , Unless Otherwise Specified)	Characteristic Values		
		Min.	Typ.	Max.
$BV_{DSS}$	$V_{GS} = 0\text{V}$ , $I_D = 250\mu\text{A}$	700		V
$V_{GS(th)}$	$V_{DS} = V_{GS}$ , $I_D = 250\mu\text{A}$	2.5		V
$I_{GSS}$	$V_{GS} = \pm 30\text{V}$ , $V_{DS} = 0\text{V}$			$\pm 100$ nA
$I_{DSS}$	$V_{DS} = V_{DSS}$ , $V_{GS} = 0\text{V}$ $T_J = 125^\circ\text{C}$			5 $\mu\text{A}$ 50 $\mu\text{A}$
$R_{DS(on)}$	$V_{GS} = 10\text{V}$ , $I_D = 0.5 \cdot I_{D25}$ , Note 1			850 m $\Omega$

$$V_{DSS} = 700\text{V}$$

$$I_{D25} = 4\text{A}$$

$$R_{DS(on)} \leq 850\text{m}\Omega$$

TO-251 (IXTU)

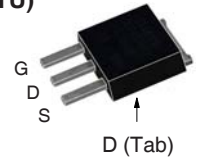

TO-252 (IXTY)

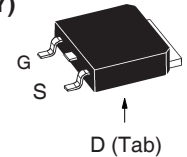

TO-263 (IXTA)

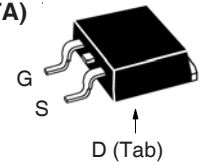

TO-220 (IXTP)

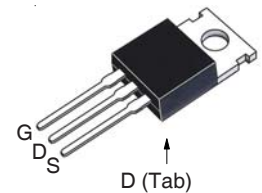
 G = Gate      D = Drain  
 S = Source    Tab = Drain

**Features**

- International Standard Packages
- Low  $R_{DS(ON)}$  and  $Q_G$
- Avalanche Rated
- Low Package Inductance

**Advantages**

- High Power Density
- Easy to Mount
- Space Savings

**Applications**

- Switch-Mode and Resonant-Mode Power Supplies
- DC-DC Converters
- PFC Circuits
- AC and DC Motor Drives
- Robotics and Servo Controls

Symbol	Test Conditions ( $T_J = 25^\circ\text{C}$ , Unless Otherwise Specified)	Characteristic Values		
		Min.	Typ.	Max
$g_{fs}$	$V_{DS} = 10\text{V}$ , $I_D = 0.5 \cdot I_{D25}$ , Note 1	2.6	4.0	S
$R_{Gi}$	Gate Input Resistance		13	$\Omega$
$C_{iss}$	$V_{GS} = 0\text{V}$ , $V_{DS} = 25\text{V}$ , $f = 1\text{MHz}$		386	pF
$C_{oss}$			280	pF
$C_{rss}$			1	pF
<b>Effective Output Capacitance</b>				
$C_{o(er)}$	Energy related	$V_{GS} = 0\text{V}$ $V_{DS} = 0.8 \cdot V_{DSS}$	29	pF
$C_{o(tr)}$	Time related		80	pF
<b>Resistive Switching Times</b>				
$t_{d(on)}$	$V_{GS} = 10\text{V}$ , $V_{DS} = 0.5 \cdot V_{DSS}$ , $I_D = 0.5 \cdot I_{D25}$ $R_G = 50\Omega$ (External)		20	ns
$t_r$			27	ns
$t_{d(off)}$			66	ns
$t_f$			28	ns
$Q_{g(on)}$	$V_{GS} = 10\text{V}$ , $V_{DS} = 0.5 \cdot V_{DSS}$ , $I_D = 0.5 \cdot I_{D25}$		11.8	nC
$Q_{gs}$			3.8	nC
$Q_{gd}$			3.5	nC
$R_{thJC}$	TO-220			1.56 $^\circ\text{C/W}$
$R_{thCS}$			0.50	$^\circ\text{C/W}$

### Source-Drain Diode

Symbol	Test Conditions ( $T_J = 25^\circ\text{C}$ , Unless Otherwise Specified)	Characteristic Values		
		Min.	Typ.	Max
$I_S$	$V_{GS} = 0\text{V}$			4 A
$I_{SM}$	Repetitive, pulse Width Limited by $T_{JM}$			16 A
$V_{SD}$	$I_F = I_S$ , $V_{GS} = 0\text{V}$ , Note 1			1.4 V
$t_{rr}$	$I_F = 2\text{A}$ , $-di/dt = 100\text{A}/\mu\text{s}$ $V_R = 100\text{V}$		186	ns
$Q_{RM}$			1.3	$\mu\text{C}$
$I_{RM}$			14.0	A

Note 1. Pulse test,  $t \leq 300\mu\text{s}$ , duty cycle,  $d \leq 2\%$ .

### PRELIMINARY TECHNICAL INFORMATION

The product presented herein is under development. The Technical Specifications offered are derived from a subjective evaluation of the design, based upon prior knowledge and experience, and constitute a "considered reflection" of the anticipated result. IXYS reserves the right to change limits, test conditions, and dimensions without notice.

IXYS Reserves the Right to Change Limits, Test Conditions, and Dimensions.

IXYS MOSFETs and IGBTs are covered by one or more of the following U.S. patents:	4,835,592	4,931,844	5,049,961	5,237,481	6,162,665	6,404,065B1	6,683,344	6,727,585	7,005,734B2	7,157,338B2
	4,860,072	5,017,508	5,063,307	5,381,025	6,259,123B1	6,534,343	6,710,405B2	6,759,692	7,063,975B2	
	4,881,106	5,034,796	5,187,117	5,486,715	6,306,728B1	6,583,505	6,710,463	6,771,478B2	7,071,537	

Fig. 1. Output Characteristics @  $T_J = 25^\circ\text{C}$

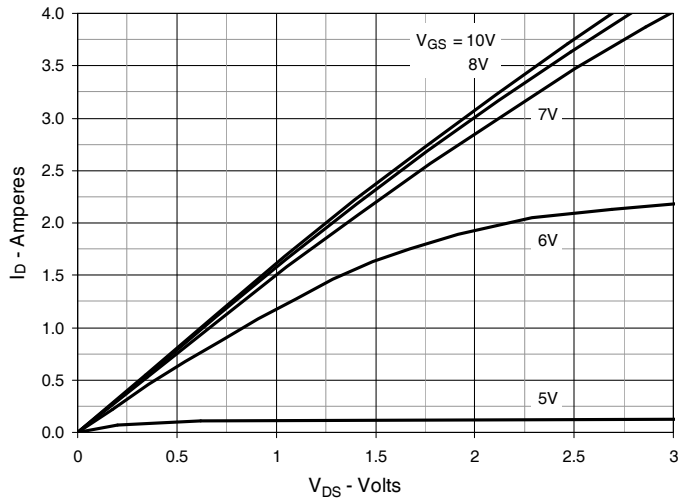

Fig. 2. Extended Output Characteristics @  $T_J = 25^\circ\text{C}$

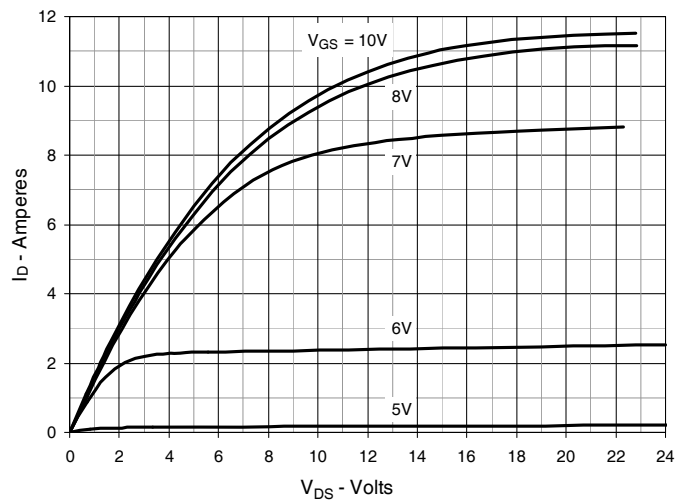

Fig. 3. Output Characteristics @  $T_J = 125^\circ\text{C}$

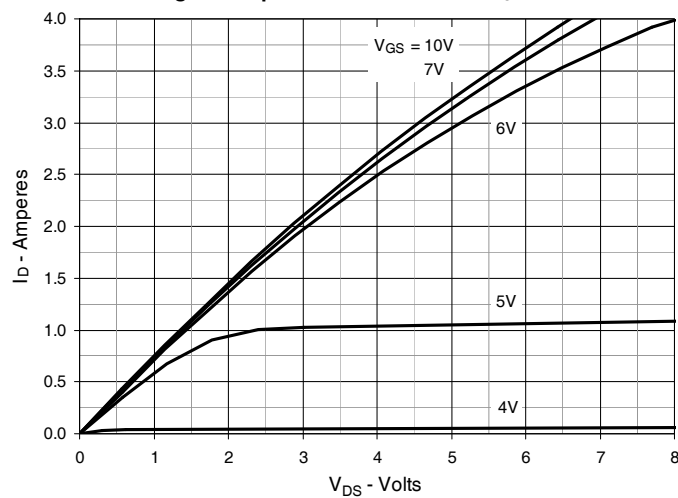

Fig. 4.  $R_{DS(on)}$  Normalized to  $I_D = 2\text{A}$  Value vs. Junction Temperature

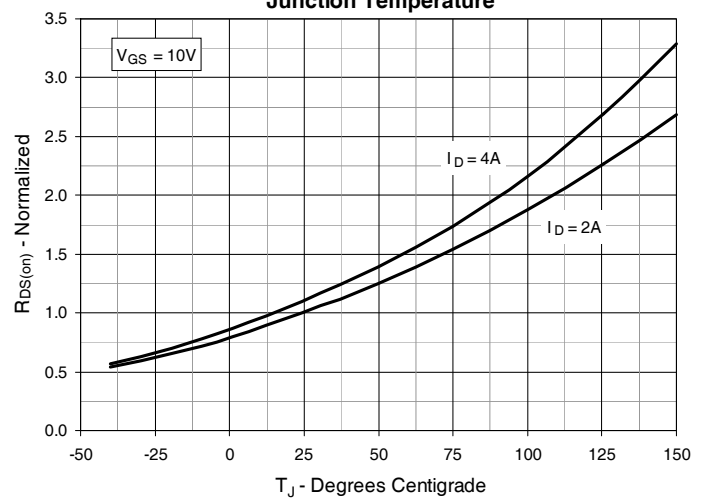

Fig. 5.  $R_{DS(on)}$  Normalized to  $I_D = 2\text{A}$  Value vs. Drain Current

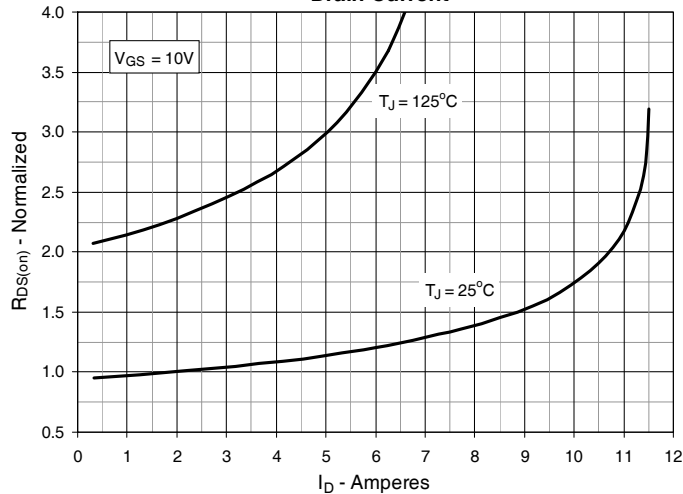

Fig. 6. Normalized Breakdown & Threshold Voltages vs. Junction Temperature

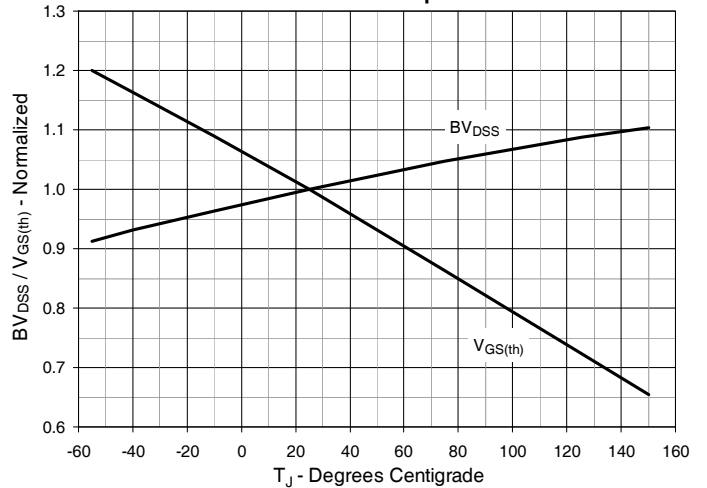

Fig. 7. Maximum Drain Current vs. Case Temperature

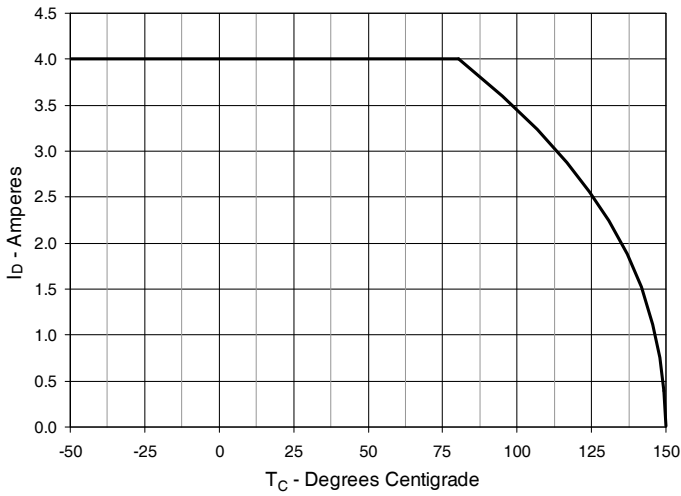

Fig. 8. Input Admittance

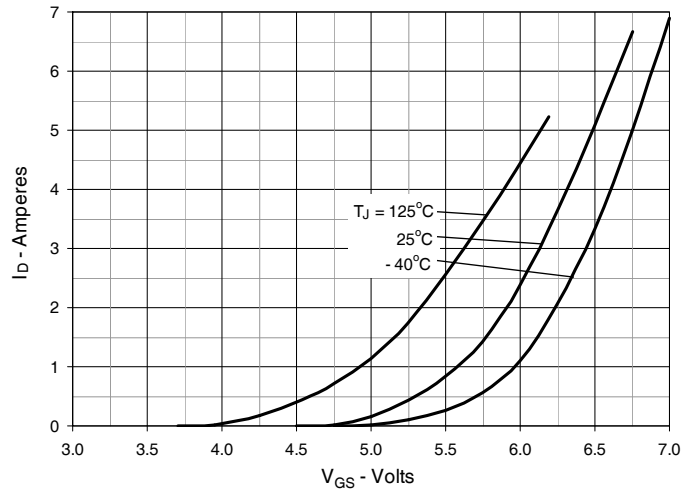

Fig. 9. Transconductance

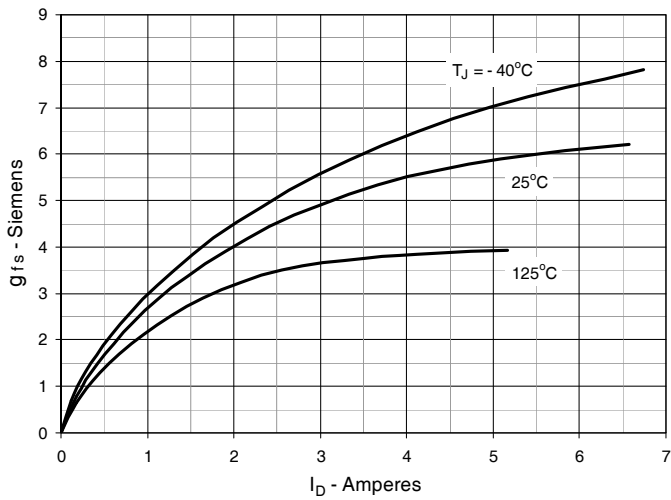

Fig. 10. Forward Voltage Drop of Intrinsic Diode

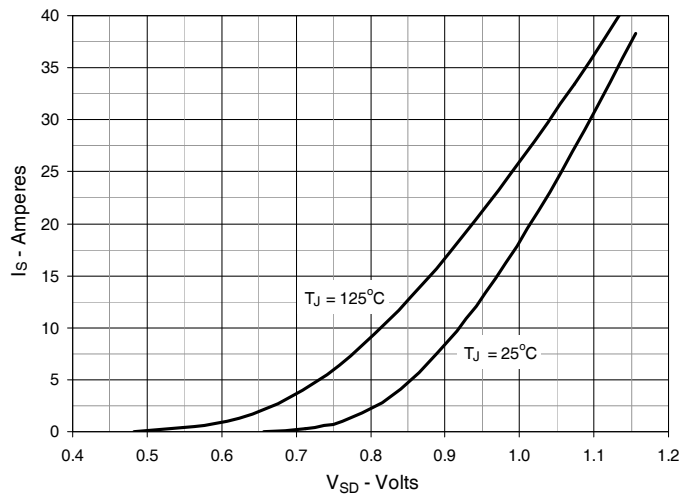

Fig. 11. Gate Charge

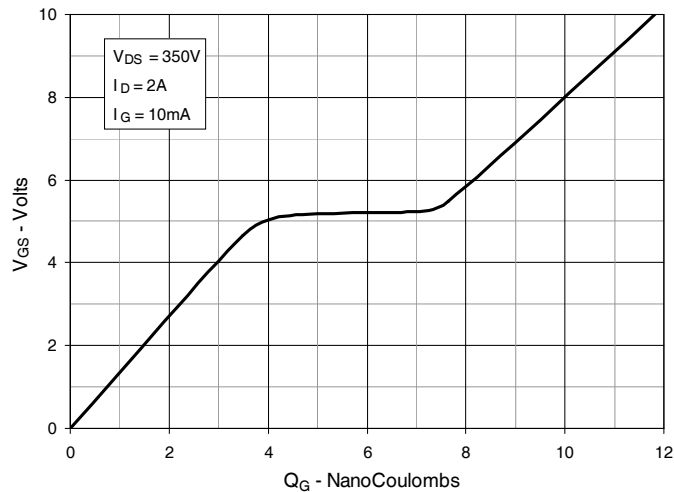

Fig. 12. Capacitance

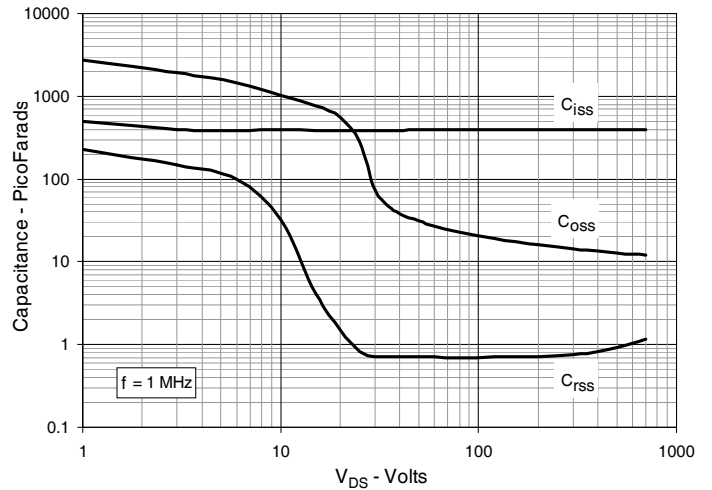

Fig. 13. Output Capacitance Stored Energy

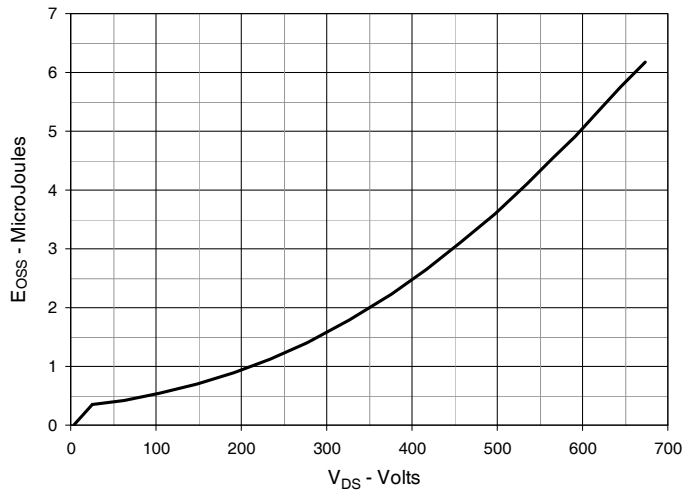

Fig. 14. Forward-Bias Safe Operating Area

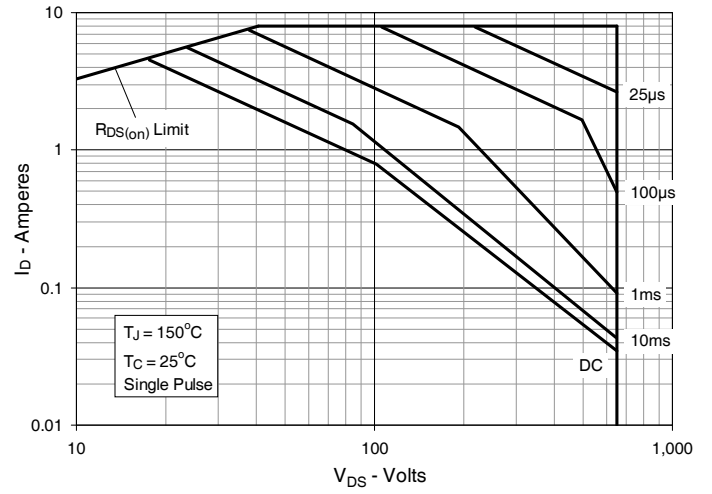
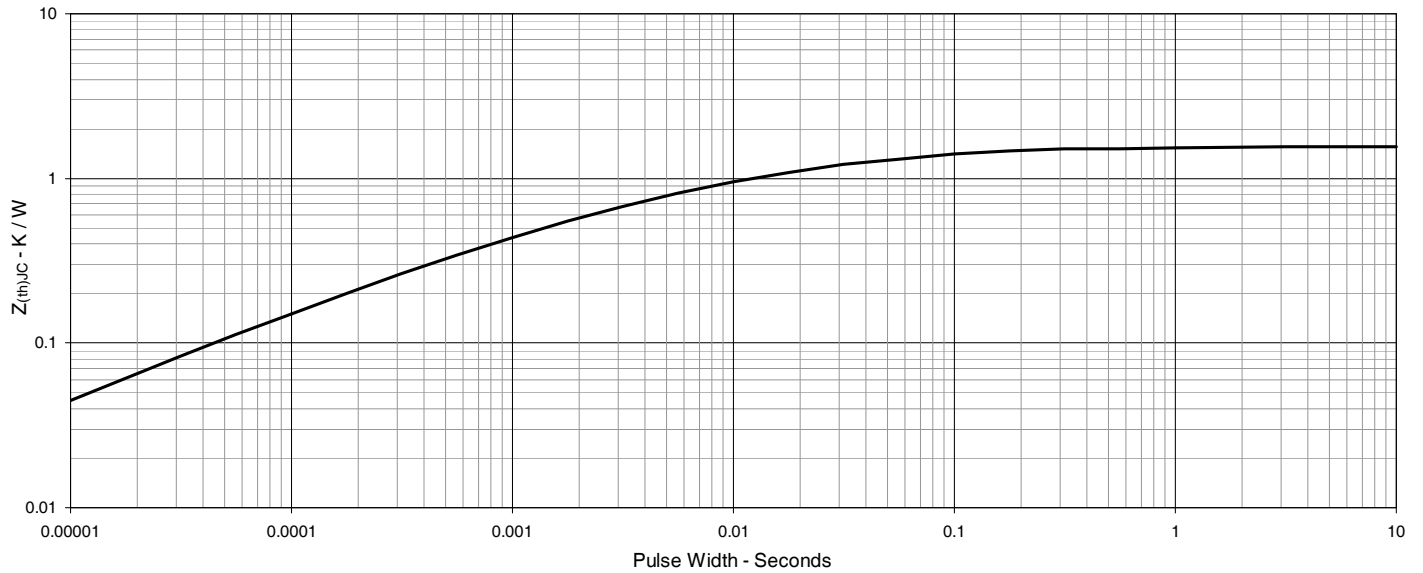
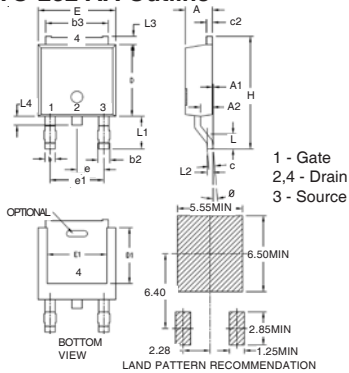

Fig. 15. Maximum Transient Thermal Impedance



### TO-252 AA Outline



SYM	INCHES		MILLIMETERS	
	MIN	MAX	MIN	MAX
A	.086	.094	2.19	2.38
A1	0	.005	0	0.12
A2	.038	.046	0.97	1.17
b	.025	.035	0.64	0.89
b2	.030	.045	0.76	1.14
b3	.200	.215	5.08	5.46
c	.018	.024	0.46	0.61
c2	.018	.023	0.46	0.58
D	.235	.245	5.97	6.22
D1	.180	.205	4.57	5.21
E	.250	.265	6.35	6.73
E1	.170	.205	4.32	5.21
e	.090 BSC		2.28 BSC	
e1	.180 BSC		4.57 BSC	
H	.370	.410	9.40	10.42
L	.055	.070	1.40	1.78
L1	.100	.115	2.54	2.92
L2	.020 BSC		0.50 BSC	
L3	.025	.040	0.64	1.02
L4	.025	.040	0.64	1.02
θ	0°	10°	0°	10°

### TO-263 Outline

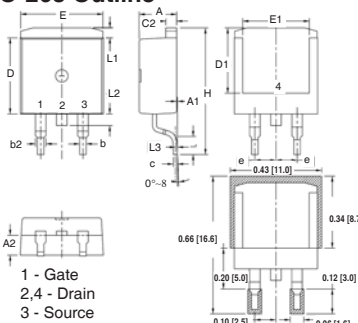

SYM	INCHES		MILLIMETER	
	MIN	MAX	MIN	MAX
A	.170	.185	4.30	4.70
A1	.000	.008	0.00	0.20
A2	.091	.098	2.30	2.50
b	.028	.035	0.70	0.90
b2	.046	.060	1.18	1.52
C	.018	.024	0.45	0.60
C2	.049	.060	1.25	1.52
D	.340	.370	8.63	9.40
D1	.300	.327	7.62	8.30
E	.380	.410	9.65	10.41
E1	.270	.330	6.86	8.38
e	.100 BSC		2.54 BSC	
H	.580	.620	14.73	15.75
L	.075	.105	1.91	2.67
L1	.039	.060	1.00	1.52
L2	—	.070	—	1.77
L3	.010 BSC		0.254 BSC	

### TO-220 Outline

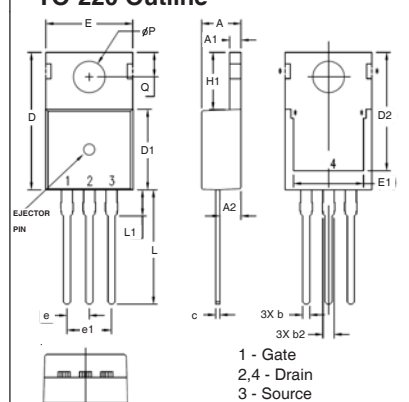

SYM	INCHES		MILLIMETERS	
	MIN	MAX	MIN	MAX
A	.169	.185	4.30	4.70
A1	.047	.055	1.20	1.40
A2	.079	.106	2.00	2.70
b	.024	.039	0.60	1.00
b2	.045	.057	1.15	1.45
c	.014	.026	0.35	0.65
D	.587	.626	14.90	15.90
D1	.335	.370	8.50	9.40
(D2)	.500	.531	12.70	13.50
E	.382	.406	9.70	10.30
(E1)	.283	.323	7.20	8.20
e	.100 BSC		2.54 BSC	
e1	.200 BSC		5.08 BSC	
H1	.244	.268	6.20	6.80
L	.492	.547	12.50	13.90
L1	.110	.154	2.80	3.90
∅P	.134	.150	3.40	3.80
Q	.106	.126	2.70	3.20

### TO-251 OUTLINE

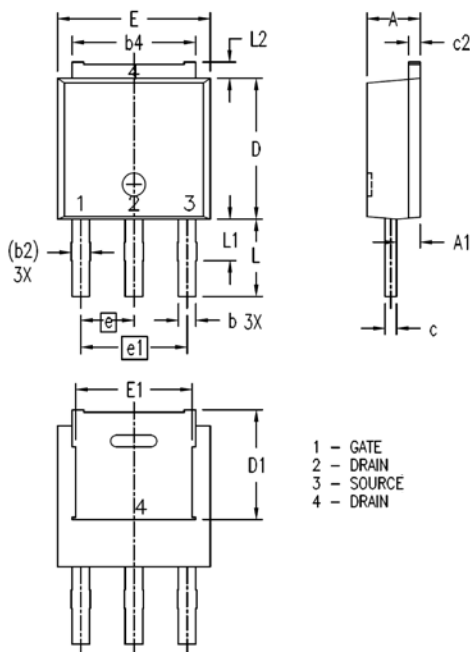

SYM	INCHES		MILLIMETERS	
	MIN	MAX	MIN	MAX
A	.087	.094	2.20	2.40
A1	.032	.048	0.82	1.22
b	.026	.034	0.66	0.86
(b2)	.030	.035	0.76	0.88
b4	.198	.222	5.04	5.64
c	.018	.024	0.45	0.60
c2	.016	.024	0.40	0.60
D	.232	.248	5.90	6.30
(D1)	.179	.195	4.55	4.95
E	.252	.268	6.40	6.80
(E1)	.191	.207	4.85	5.25
e	.090 BSC		2.28 BSC	
e1	.180 BSC		4.57 BSC	
L	.126	.138	3.20	3.50
L1	.063	.079	1.60	2.00
L2	.020	.035	0.50	0.90



---

Disclaimer Notice - Information furnished is believed to be accurate and reliable. However, users should independently evaluate the suitability of and test each product selected for their own applications. Littelfuse products are not designed for, and may not be used in, all applications. Read complete Disclaimer Notice at [www.littelfuse.com/disclaimer-electronics](http://www.littelfuse.com/disclaimer-electronics).