

**X-Class HiPerFET™  
Power MOSFET**

**IXFA24N60X  
IXFP24N60X  
IXFQ24N60X  
IXFH24N60X**

$V_{DSS} = 600V$   
 $I_{D25} = 24A$   
 $R_{DS(on)} \leq 175m\Omega$

N-Channel Enhancement Mode  
 Avalanche Rated  
 Fast Intrinsic Diode

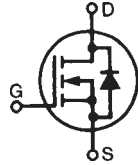

TO-263 AA (IXFA)

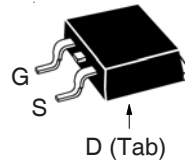

TO-220AB (IXFP)

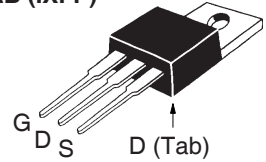

TO-3P (IXFQ)

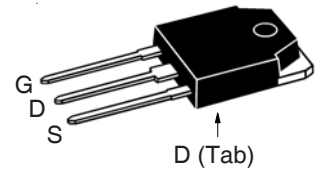

TO-247 (IXFH)

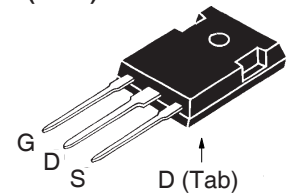

G = Gate      D = Drain  
 S = Source    Tab = Drain

Symbol	Test Conditions	Maximum Ratings	
$V_{DSS}$	$T_J = 25^\circ C$ to $150^\circ C$	600	V
$V_{DGR}$	$T_J = 25^\circ C$ to $150^\circ C$ , $R_{GS} = 1M\Omega$	600	V
$V_{GSS}$	Continuous	$\pm 30$	V
$V_{GSM}$	Transient	$\pm 40$	V
$I_{D25}$	$T_C = 25^\circ C$	24	A
$I_{DM}$	$T_C = 25^\circ C$ , Pulse Width Limited by $T_{JM}$	48	A
$I_A$	$T_C = 25^\circ C$	8	A
$E_{AS}$	$T_C = 25^\circ C$	500	mJ
$dv/dt$	$I_S \leq I_{DM}$ , $V_{DD} \leq V_{DSS}$ , $T_J \leq 150^\circ C$	50	V/ns
$P_D$	$T_C = 25^\circ C$	400	W
$T_J$		-55 ... +150	$^\circ C$
$T_{JM}$		150	$^\circ C$
$T_{stg}$		-55 ... +150	$^\circ C$
$T_L$	Maximum Lead Temperature for Soldering	300	$^\circ C$
$T_{SOLD}$	1.6 mm (0.062in.) from Case for 10s	260	$^\circ C$
$F_C$	Mounting Force (TO-263)	10..65 / 2.2..14.6	N/lb
$M_d$	Mounting Torque (TO-220, TO-3P & TO-247)	1.13 / 10	Nm/lb.in
<b>Weight</b>	TO-263	2.5	g
	TO-220	3.0	g
	TO-3P	5.5	g
	TO-247	6.0	g

Symbol	Test Conditions ( $T_J = 25^\circ C$ , Unless Otherwise Specified)	Characteristic Values		
		Min.	Typ.	Max.
$BV_{DSS}$	$V_{GS} = 0V$ , $I_D = 250\mu A$	600		V
$V_{GS(th)}$	$V_{DS} = V_{GS}$ , $I_D = 2.5mA$	2.5		V
$I_{GSS}$	$V_{GS} = \pm 30V$ , $V_{DS} = 0V$			$\pm 100$ nA
$I_{DSS}$	$V_{DS} = V_{DSS}$ , $V_{GS} = 0V$ $T_J = 125^\circ C$			20 $\mu A$
				750 $\mu A$
$R_{DS(on)}$	$V_{GS} = 10V$ , $I_D = 0.5 \cdot I_{D25}$ , Note 1			175 m $\Omega$

**Features**

- International Standard Packages
- Low  $R_{DS(ON)}$  and  $Q_G$
- Avalanche Rated
- Low Package Inductance

**Advantages**

- High Power Density
- Easy to Mount
- Space Savings

**Applications**

- Switch-Mode and Resonant-Mode Power Supplies
- DC-DC Converters
- PFC Circuits
- AC and DC Motor Drives
- Robotics and Servo Controls

Symbol	Test Conditions ( $T_J = 25^\circ\text{C}$ , Unless Otherwise Specified)	Characteristic Values		
		Min.	Typ.	Max
$g_{fs}$	$V_{DS} = 10\text{V}$ , $I_D = 0.5 \cdot I_{D25}$ , Note 1	7	12	S
$R_{Gi}$	Gate Input Resistance		2.1	$\Omega$
$C_{iss}$	$V_{GS} = 0\text{V}$ , $V_{DS} = 25\text{V}$ , $f = 1\text{MHz}$		1910	pF
$C_{oss}$			1400	pF
$C_{rss}$			18	pF
<b>Effective Output Capacitance</b>				
$C_{o(er)}$	Energy related	$V_{GS} = 0\text{V}$ $V_{DS} = 0.8 \cdot V_{DSS}$	100	pF
$C_{o(tr)}$	Time related		330	pF
<b>Resistive Switching Times</b>				
$t_{d(on)}$	$V_{GS} = 10\text{V}$ , $V_{DS} = 0.5 \cdot V_{DSS}$ , $I_D = 0.5 \cdot I_{D25}$ $R_G = 5\Omega$ (External)		18	ns
$t_r$			29	ns
$t_{d(off)}$			45	ns
$t_f$			15	ns
$Q_{g(on)}$	$V_{GS} = 10\text{V}$ , $V_{DS} = 0.5 \cdot V_{DSS}$ , $I_D = 0.5 \cdot I_{D25}$		47	nC
$Q_{gs}$			11	nC
$Q_{gd}$			23	nC
$R_{thJC}$				0.31 $^\circ\text{C/W}$
$R_{thCS}$	TO-220		0.50	$^\circ\text{C/W}$
	TO-247 & TO-3P		0.25	$^\circ\text{C/W}$

### Source-Drain Diode

Symbol	Test Conditions ( $T_J = 25^\circ\text{C}$ , Unless Otherwise Specified)	Characteristic Values		
		Min.	Typ.	Max
$I_S$	$V_{GS} = 0\text{V}$			24 A
$I_{SM}$	Repetitive, pulse Width Limited by $T_{JM}$			96 A
$V_{SD}$	$I_F = I_S$ , $V_{GS} = 0\text{V}$ , Note 1			1.4 V
$t_{rr}$	$I_F = 12\text{A}$ , $-di/dt = 100\text{A}/\mu\text{s}$ $V_R = 100\text{V}$		140	ns
$Q_{RM}$			840	nC
$I_{RM}$			12	A

Note 1. Pulse test,  $t \leq 300\mu\text{s}$ , duty cycle,  $d \leq 2\%$ .

### PRELIMINARY TECHNICAL INFORMATION

The product presented herein is under development. The Technical Specifications offered are derived from a subjective evaluation of the design, based upon prior knowledge and experience, and constitute a "considered reflection" of the anticipated result. IXYS reserves the right to change limits, test conditions, and dimensions without notice.

IXYS Reserves the Right to Change Limits, Test Conditions, and Dimensions.

IXYS MOSFETs and IGBTs are covered by one or more of the following U.S. patents:	4,835,592	4,931,844	5,049,961	5,237,481	6,162,665	6,404,065B1	6,683,344	6,727,585	7,005,734B2	7,157,338B2
	4,860,072	5,017,508	5,063,307	5,381,025	6,259,123B1	6,534,343	6,710,405B2	6,759,692	7,063,975B2	
	4,881,106	5,034,796	5,187,117	5,486,715	6,306,728B1	6,583,505	6,710,463	6,771,478B2	7,071,537	

Fig. 1. Output Characteristics @  $T_J = 25^\circ\text{C}$

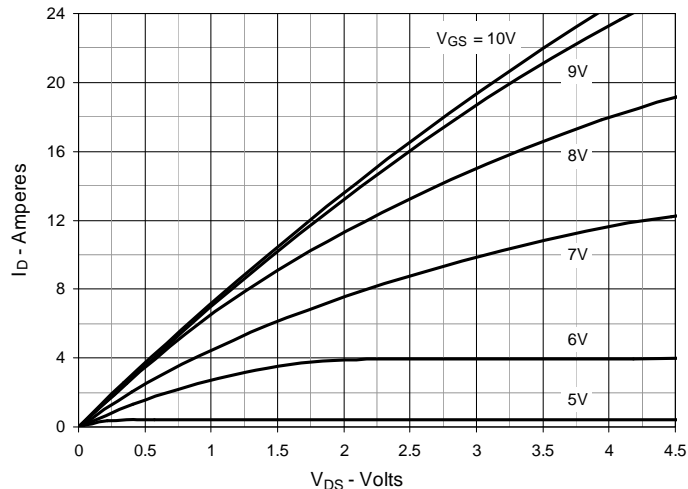

Fig. 2. Extended Output Characteristics @  $T_J = 25^\circ\text{C}$

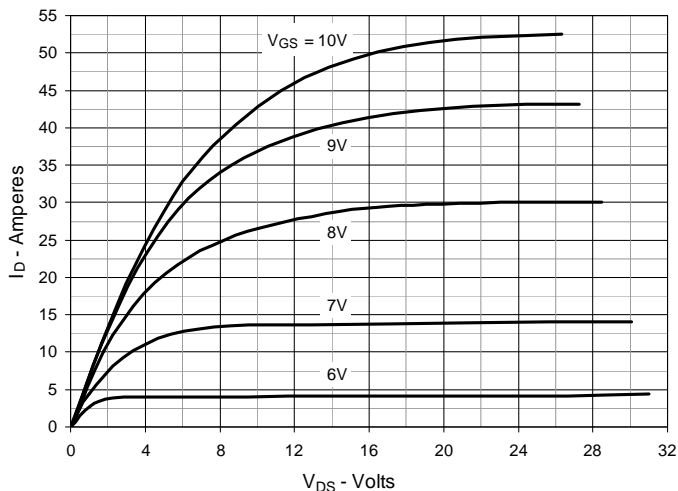

Fig. 3. Output Characteristics @  $T_J = 125^\circ\text{C}$

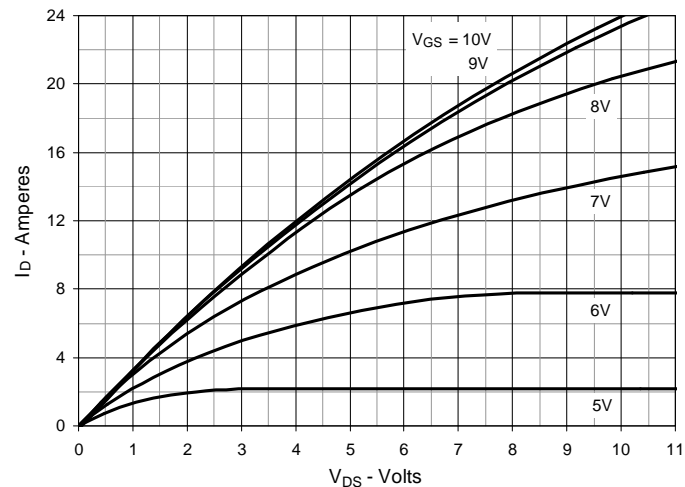

Fig. 4.  $R_{DS(on)}$  Normalized to  $I_D = 12\text{A}$  Value vs. Junction Temperature

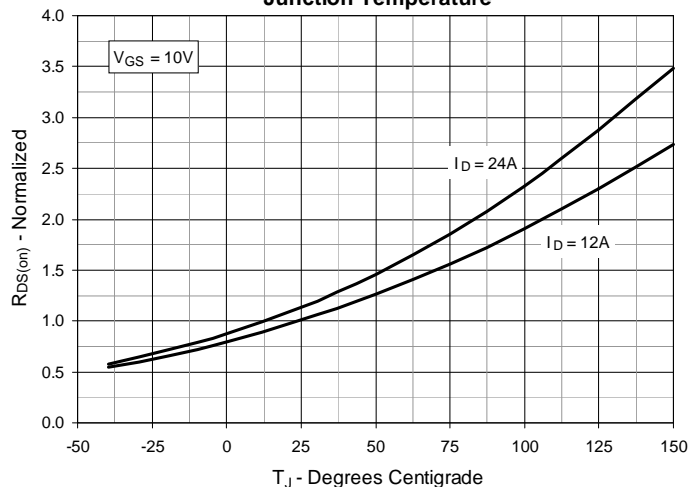

Fig. 5.  $R_{DS(on)}$  Normalized to  $I_D = 12\text{A}$  Value vs. Drain Current

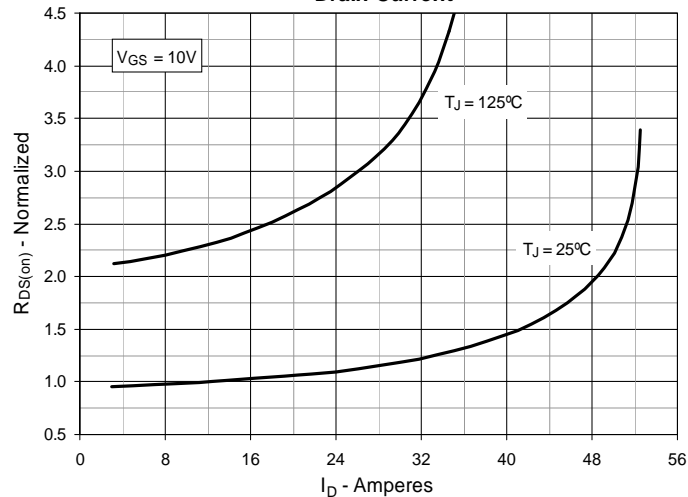

Fig. 6. Maximum Drain Current vs. Case Temperature

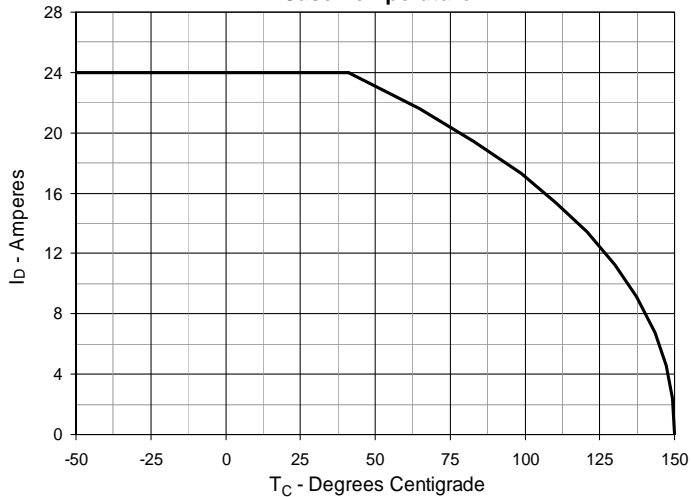

Fig. 7. Input Admittance

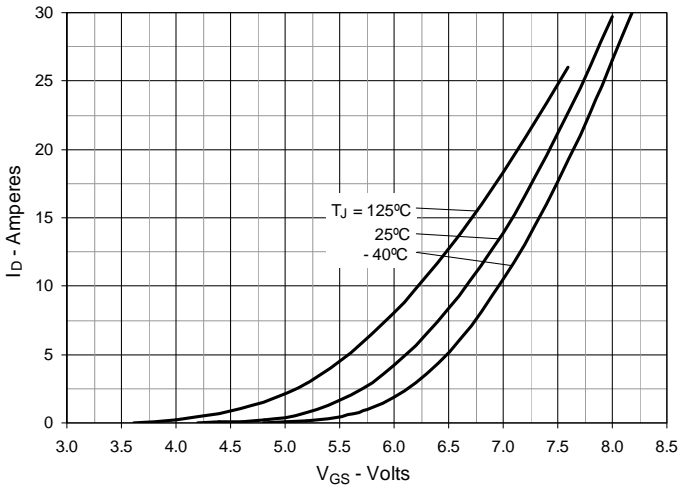

Fig. 8. Transconductance

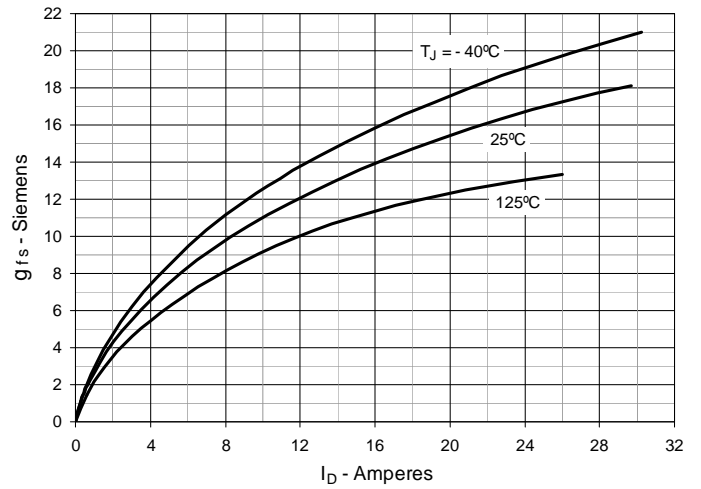

Fig. 9. Forward Voltage Drop of Intrinsic Diode

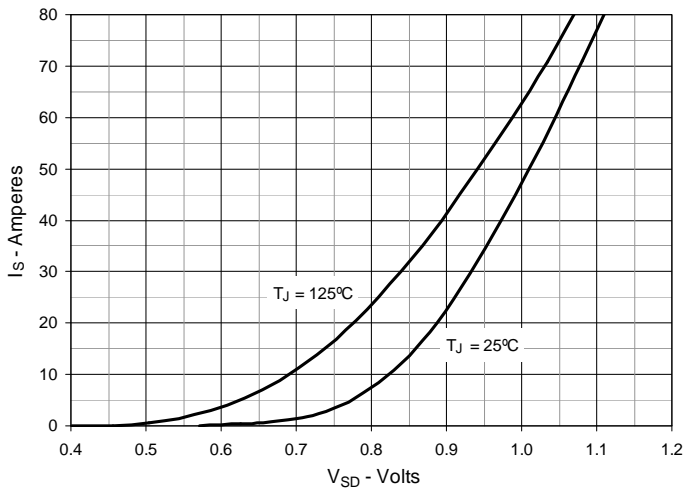

Fig. 10. Gate Charge

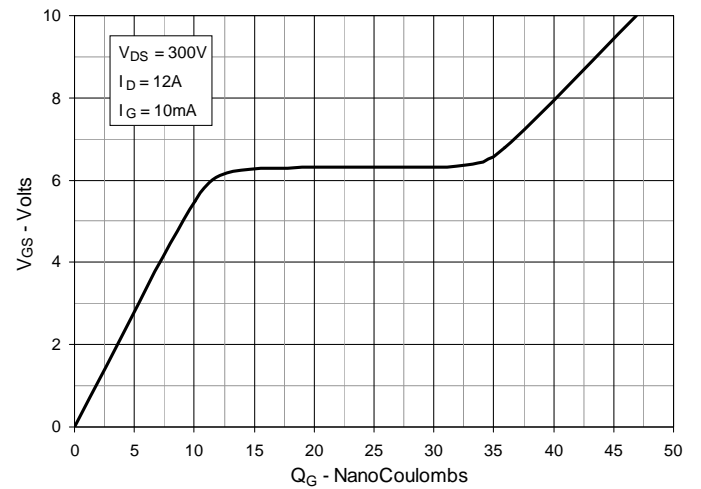

Fig. 11. Capacitance

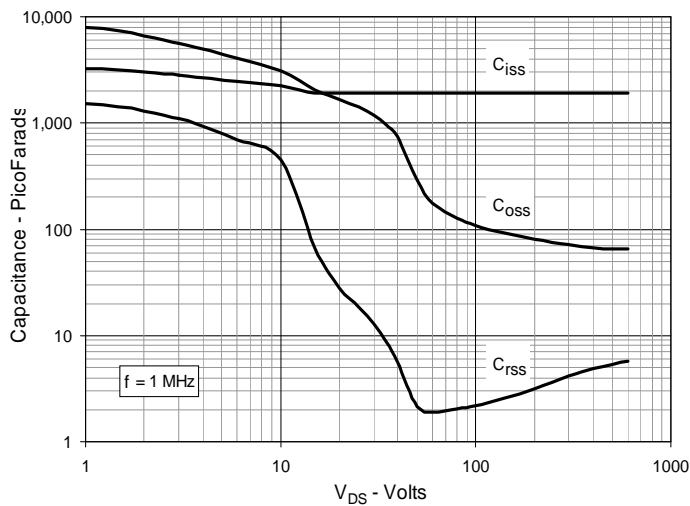

Fig. 12. Forward-Bias Safe Operating Area

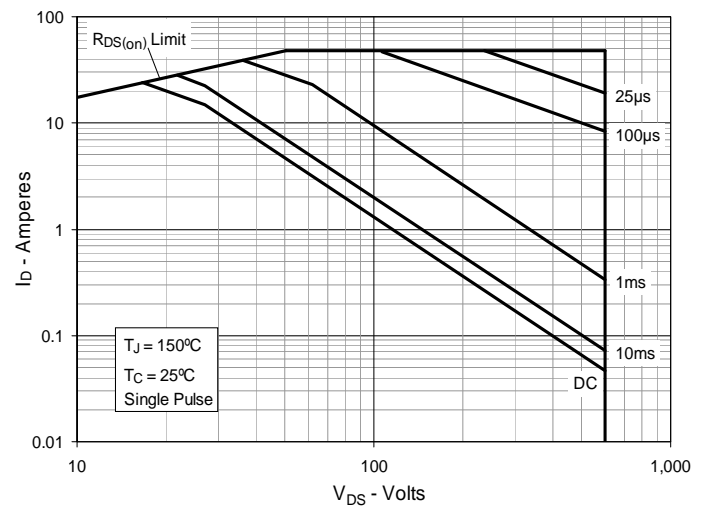

Fig. 13. Output Capacitance Stored Energy

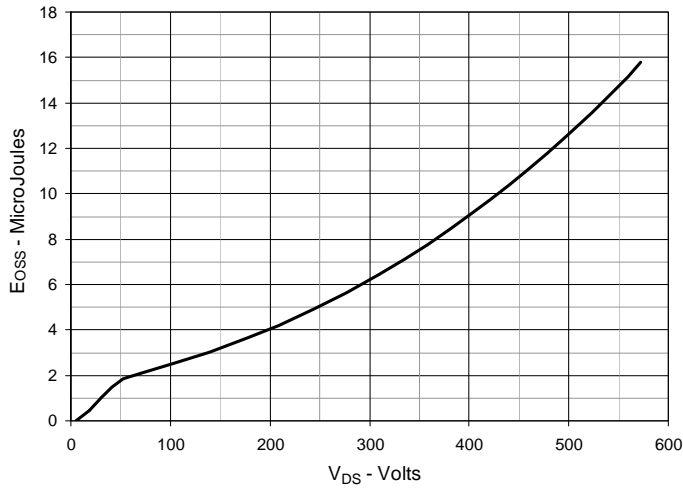
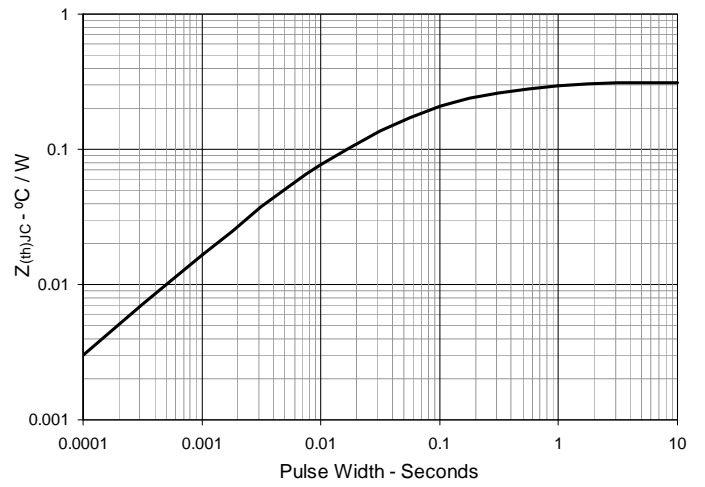
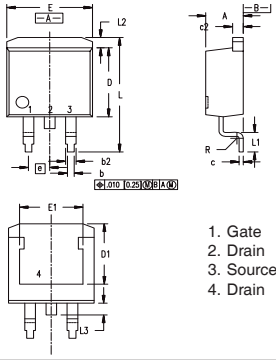

Fig. 14. Maximum Transient Thermal Impedance



### TO-263 Outline



1. Gate  
2. Drain  
3. Source  
4. Drain

Dim.	Millimeter		Inches	
	Min.	Max.	Min.	Max.
A	4.06	4.83	.160	.190
b	0.51	0.99	.020	.039
b2	1.14	1.40	.045	.055
c	0.40	0.74	.016	.029
c2	1.14	1.40	.045	.055
D	8.64	9.65	.340	.380
D1	8.00	8.89	.280	.320
E	9.65	10.41	.380	.405
E1	6.22	8.13	.270	.320
e	2.54	BSC	.100	BSC
L	14.61	15.88	.575	.625
L1	2.29	2.79	.090	.110
L2	1.02	1.40	.040	.055
L3	1.27	1.78	.050	.070
L4	0	0.13	0	.005

### TO-3P Outline

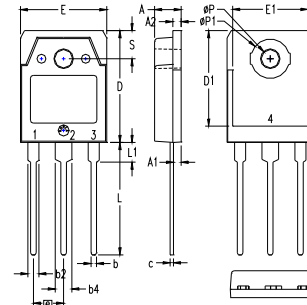

1. Gate  
2. Drain  
3. Source  
4. Drain

SYM	INCHES		MILLIMETERS	
	MIN	MAX	MIN	MAX
A	.185	.193	4.70	4.90
A1	.051	.059	1.30	1.50
A2	.057	.065	1.45	1.65
b	.035	.045	0.90	1.15
b2	.075	.087	1.90	2.20
b4	.114	.126	2.90	3.20
c	.022	.031	0.55	0.80
D	.780	.799	19.80	20.30
D1	.665	.677	16.90	17.20
E	.610	.622	15.50	15.80
E1	.531	.539	13.50	13.70
e	.215 BSC		5.45 BSC	
L	.779	.795	19.80	20.20
L1	.134	.142	3.40	3.60
ØP	.126	.134	3.20	3.40
ØP1	.272	.280	6.90	7.10
S	.193	.201	4.90	5.10

### TO-220 Outline

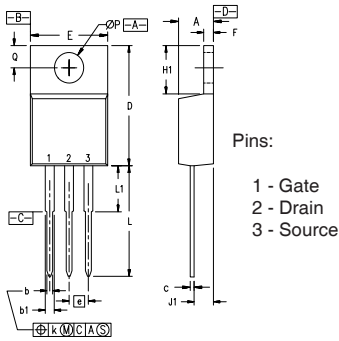

- Pins:  
1 - Gate  
2 - Drain  
3 - Source

SYM	INCHES		MILLIMETERS	
	MIN	MAX	MIN	MAX
A	.170	.190	4.32	4.83
b	.025	.040	0.64	1.02
b1	.045	.065	1.15	1.65
c	.014	.022	0.35	0.56
D	.580	.630	14.73	16.00
E	.390	.420	9.91	10.66
e	.100 BSC		2.54 BSC	
F	.045	.055	1.14	1.40
H1	.230	.270	5.85	6.85
J1	.090	.110	2.29	2.79
k	0	.015	0	0.38
L	.500	.550	12.70	13.97
L1	.110	.230	2.79	5.84
ØP	.139	.161	3.53	4.08
Q	.100	.125	2.54	3.18

### TO-247 Outline

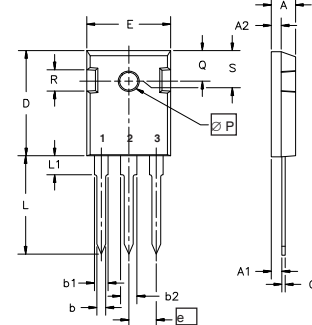

- Terminals: 1 - Gate 2 - Drain  
3 - Source

Dim.	Millimeter		Inches	
	Min.	Max.	Min.	Max.
A	4.7	5.3	.185	.209
A <sub>1</sub>	2.2	2.54	.087	.102
A <sub>2</sub>	2.2	2.6	.059	.098
b	1.0	1.4	.040	.055
b <sub>1</sub>	1.65	2.13	.065	.084
b <sub>2</sub>	2.87	3.12	.113	.123
C	.4	.8	.016	.031
D	20.80	21.46	.819	.845
E	15.75	16.26	.610	.640
e	5.20	5.72	0.205	0.225
L	19.81	20.32	.780	.800
L1		4.50		.177
ØP	3.55	3.65	.140	.144
Q	5.89	6.40	0.232	0.252
R	4.32	5.49	.170	.216
S	6.15	BSC	242	BSC



---

Disclaimer Notice - Information furnished is believed to be accurate and reliable. However, users should independently evaluate the suitability of and test each product selected for their own applications. Littelfuse products are not designed for, and may not be used in, all applications. Read complete Disclaimer Notice at [www.littelfuse.com/disclaimer-electronics](http://www.littelfuse.com/disclaimer-electronics).