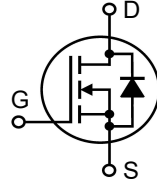


# X3-Class HiPerFET™ Power MOSFET

# IXFK240N25X3 IXFX240N25X3

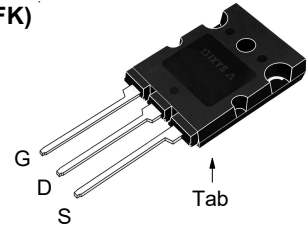
$V_{DSS} = 250V$   
 $I_{D25} = 240A$   
 $R_{DS(on)} \leq 5.0m\Omega$

N-Channel Enhancement Mode  
 Avalanche Rated  
 Fast Intrinsic Diode

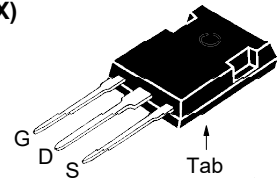


Symbol	Test Conditions	Maximum Ratings	
$V_{DSS}$	$T_J = 25^\circ C$ to $150^\circ C$	250	V
$V_{DGR}$	$T_J = 25^\circ C$ to $150^\circ C$ , $R_{GS} = 1M\Omega$	250	V
$V_{GSS}$	Continuous	$\pm 20$	V
$V_{GSM}$	Transient	$\pm 30$	V
$I_{D25}$	$T_C = 25^\circ C$ (Chip Capability)	240	A
$I_{L(RMS)}$	External Lead Current Limit	160	A
$I_{DM}$	$T_C = 25^\circ C$ , Pulse Width Limited by $T_{JM}$	600	A
$I_A$	$T_C = 25^\circ C$	200	A
$E_{AS}$	$T_C = 25^\circ C$	3	J
$dv/dt$	$I_S \leq I_{DM}$ , $V_{DD} \leq V_{DSS}$ , $T_J \leq 150^\circ C$	50	V/ns
$P_D$	$T_C = 25^\circ C$	1250	W
$T_J$		-55 ... +150	$^\circ C$
$T_{JM}$		150	$^\circ C$
$T_{stg}$		-55 ... +150	$^\circ C$
$T_L$	Maximum Lead Temperature for Soldering 1.6 mm (0.062 in.) from Case for 10s	300	$^\circ C$
$M_d$	Mounting Torque (TO-264K)	1.13/10	Nm/lb.in
$F_c$	Mounting Force (PLUS247)	20..120 / 4.5..27	N/lb
<b>Weight</b>	TO-264K	10	g
	PLUS247	6	g

TO-264K  
(IXFK)



PLUS247  
(IXFX)



G = Gate      D = Drain  
 S = Source    Tab = Drain

## Features

- International Standard Packages
- Low  $R_{DS(ON)}$  and  $Q_G$
- Avalanche Rated
- Low Package Inductance

## Advantages

- High Power Density
- Easy to Mount
- Space Savings

## Applications

- Switch-Mode and Resonant-Mode Power Supplies
- DC-DC Converters
- PFC Circuits
- AC and DC Motor Drives
- Robotics and Servo Controls

Symbol	Test Conditions ( $T_J = 25^\circ C$ , Unless Otherwise Specified)	Characteristic Values		
		Min.	Typ.	Max.
$BV_{DSS}$	$V_{GS} = 0V$ , $I_D = 3mA$	250		V
$V_{GS(th)}$	$V_{DS} = V_{GS}$ , $I_D = 8mA$	2.5		4.5 V
$I_{GSS}$	$V_{GS} = \pm 20V$ , $V_{DS} = 0V$			$\pm 200$ nA
$I_{DSS}$	$V_{DS} = V_{DSS}$ , $V_{GS} = 0V$ $T_J = 125^\circ C$			25 $\mu A$ 2.5 mA
$R_{DS(on)}$	$V_{GS} = 10V$ , $I_D = 0.5 \cdot I_{D25}$ , Note 1	4.1		5.0 m $\Omega$

Symbol	Test Conditions ( $T_J = 25^\circ\text{C}$ , Unless Otherwise Specified)	Characteristic Values		
		Min.	Typ.	Max
$g_{fs}$	$V_{DS} = 10\text{V}$ , $I_D = 60\text{A}$ , Note 1	80	135	S
$R_{Gi}$	Gate Input Resistance		1.8	$\Omega$
$C_{iss}$	} $V_{GS} = 0\text{V}$ , $V_{DS} = 25\text{V}$ , $f = 1\text{MHz}$		23.8	nF
$C_{oss}$			3.7	nF
$C_{rss}$			1.5	pF
<b>Effective Output Capacitance</b>				
$C_{o(er)}$	Energy related } $V_{GS} = 0\text{V}$		1400	pF
$C_{o(tr)}$	Time related } $V_{DS} = 0.8 \cdot V_{DSS}$		5480	pF
$t_{d(on)}$	} <b>Resistive Switching Times</b> $V_{GS} = 10\text{V}$ , $V_{DS} = 0.5 \cdot V_{DSS}$ , $I_D = 0.5 \cdot I_{D25}$ $R_G = 1\Omega$ (External)		36	ns
$t_r$			32	ns
$t_{d(off)}$			180	ns
$t_f$			14	ns
$Q_{g(on)}$	} $V_{GS} = 10\text{V}$ , $V_{DS} = 0.5 \cdot V_{DSS}$ , $I_D = 0.5 \cdot I_{D25}$		345	nC
$Q_{gs}$			112	nC
$Q_{gd}$			72	nC
$R_{thJC}$				0.10 $^\circ\text{C/W}$
$R_{thCS}$		0.15		$^\circ\text{C/W}$

**Source-Drain Diode**

Symbol	Test Conditions ( $T_J = 25^\circ\text{C}$ , Unless Otherwise Specified)	Characteristic Values		
		Min.	Typ.	Max
$I_S$	$V_{GS} = 0\text{V}$			240 A
$I_{SM}$	Repetitive, pulse Width Limited by $T_{JM}$			960 A
$V_{SD}$	$I_F = 100\text{A}$ , $V_{GS} = 0\text{V}$ , Note 1			1.4 V
$t_{rr}$	} $I_F = 120\text{A}$ , $-di/dt = 100\text{A}/\mu\text{s}$ $V_R = 100\text{V}$		177	ns
$Q_{RM}$			1.2	$\mu\text{C}$
$I_{RM}$			13.5	A

Note 1. Pulse test,  $t \leq 300\mu\text{s}$ , duty cycle,  $d \leq 2\%$ .

Littelfuse reserves the right to change limits, test conditions, and dimensions.

LFMOSFETs and IGBTs are covered  
 by one or more of the following U.S. patents: 4,835,592 4,931,844 5,049,961 5,237,481 6,162,665 6,404,065B1 6,683,344 6,727,585 7,005,734B2 7,157,338B2  
 4,860,072 5,017,508 5,063,307 5,381,025 6,259,123B1 6,534,343 6,710,405B2 6,759,692 7,063,975B2  
 4,881,106 5,034,796 5,187,117 5,486,715 6,306,728B1 6,583,505 6,710,463 6,771,478B2 7,071,537

Fig. 1. Output Characteristics @  $T_J = 25^\circ\text{C}$

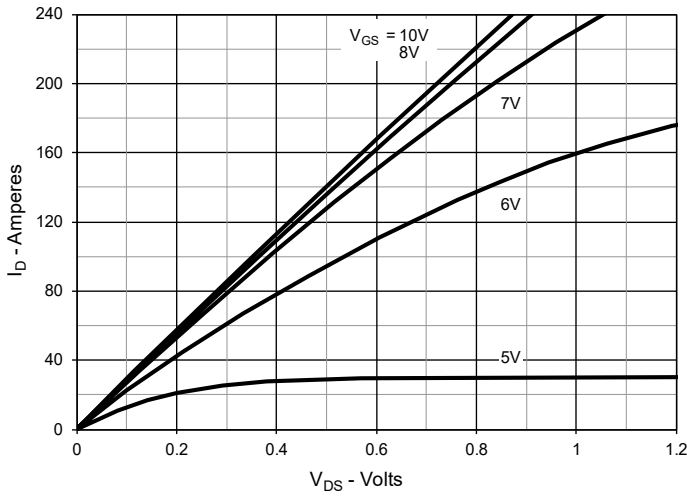


Fig. 2. Extended Output Characteristics @  $T_J = 25^\circ\text{C}$

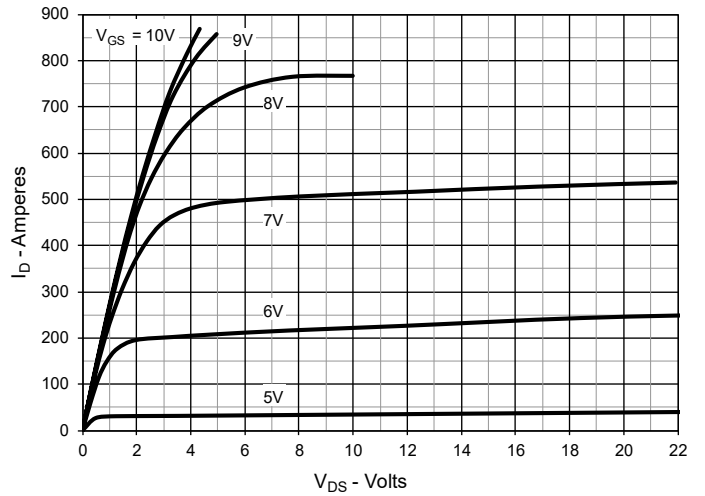


Fig. 3. Output Characteristics @  $T_J = 125^\circ\text{C}$

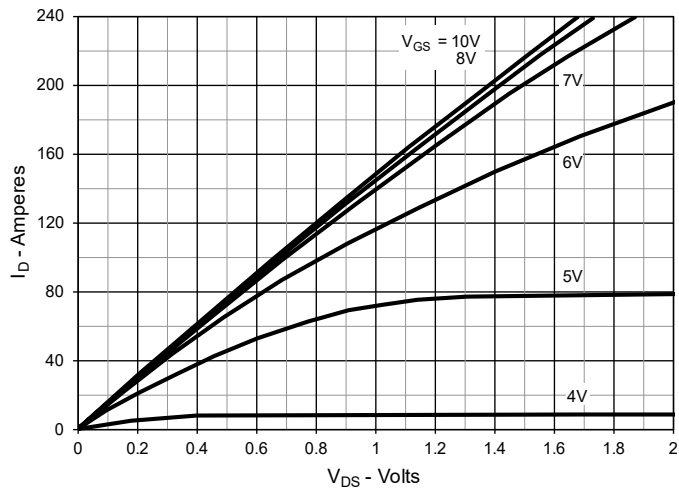


Fig. 4.  $R_{DS(on)}$  Normalized to  $I_D = 120\text{A}$  Value vs. Junction Temperature

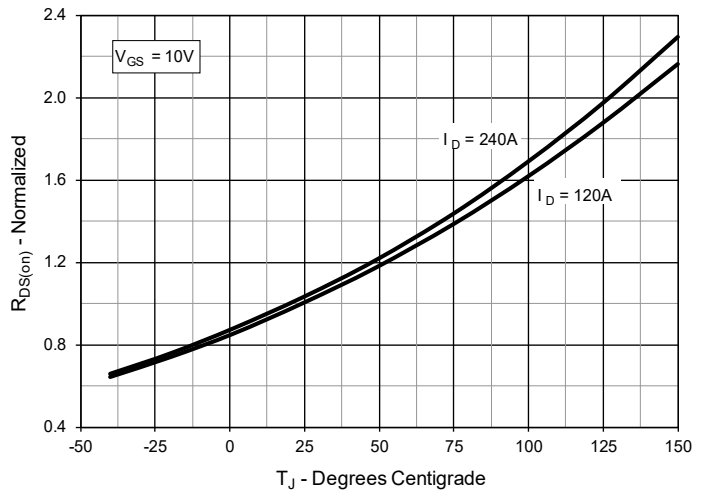


Fig. 5.  $R_{DS(on)}$  Normalized to  $I_D = 120\text{A}$  Value vs. Drain Current

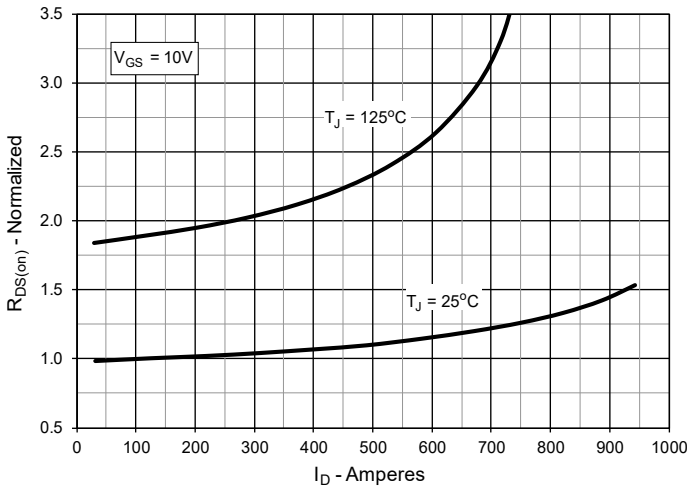
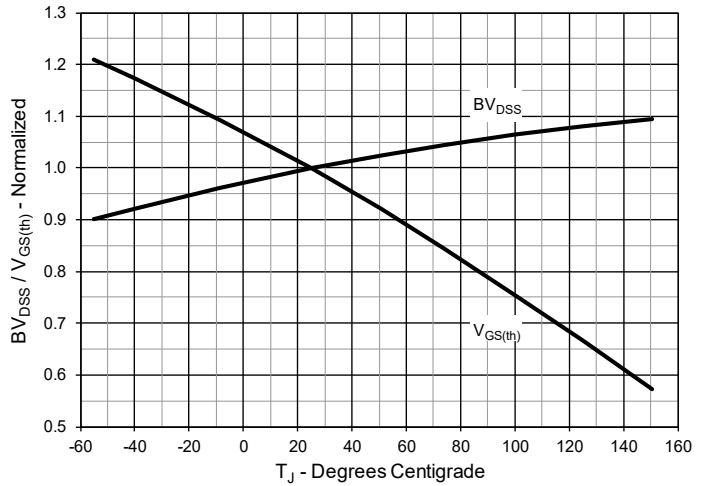
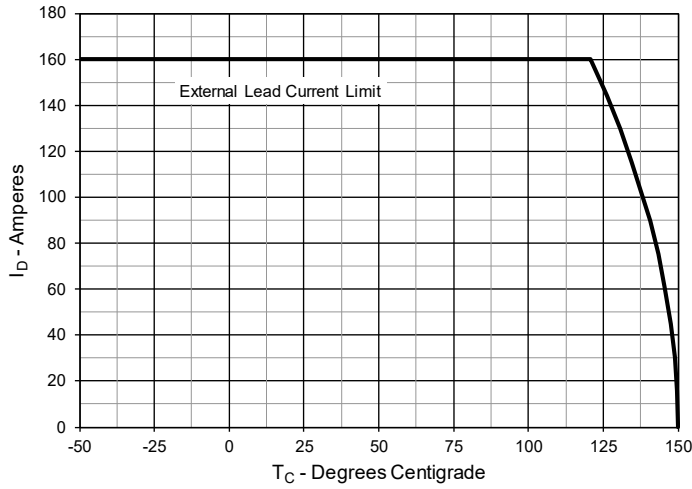


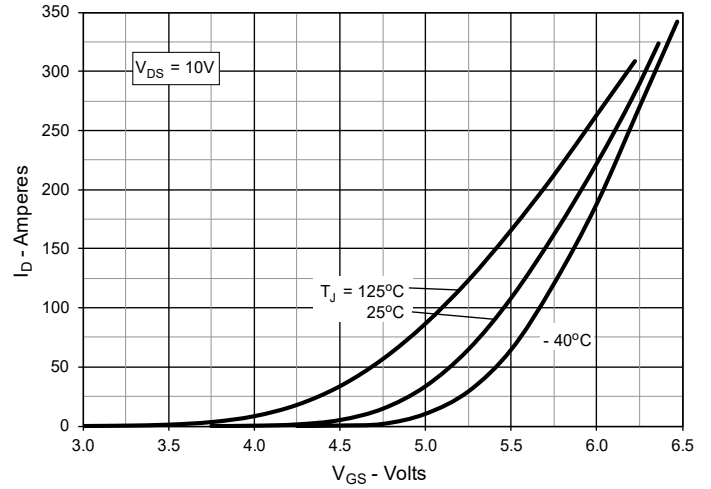
Fig. 6. Normalized Breakdown & Threshold Voltages vs. Junction Temperature



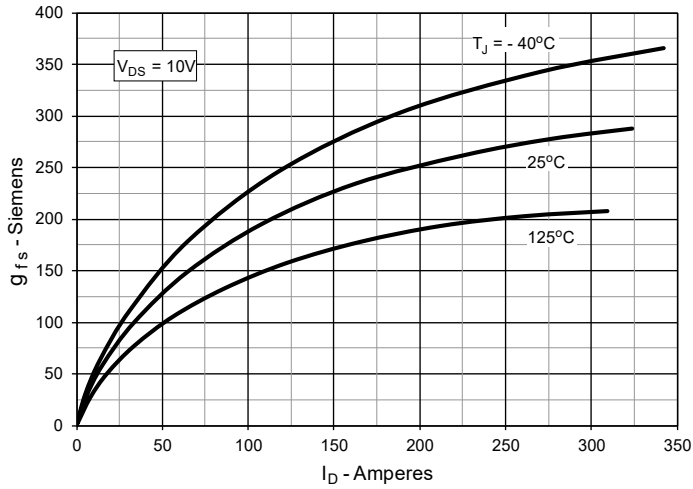
**Fig. 7. Maximum Drain Current vs. Case Temperature**



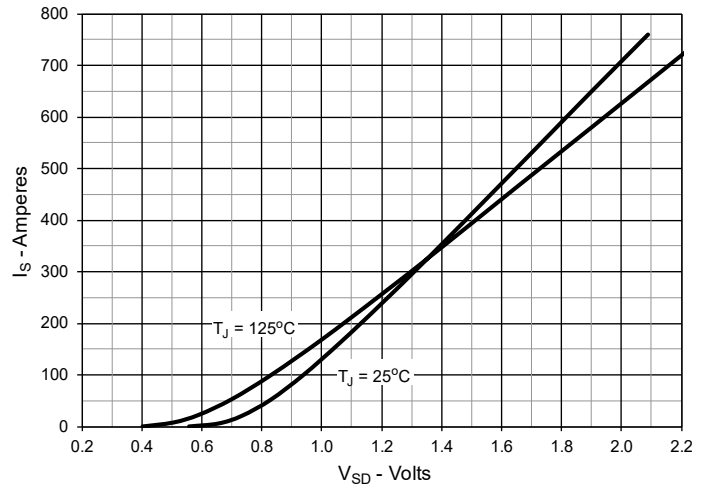
**Fig. 8. Input Admittance**



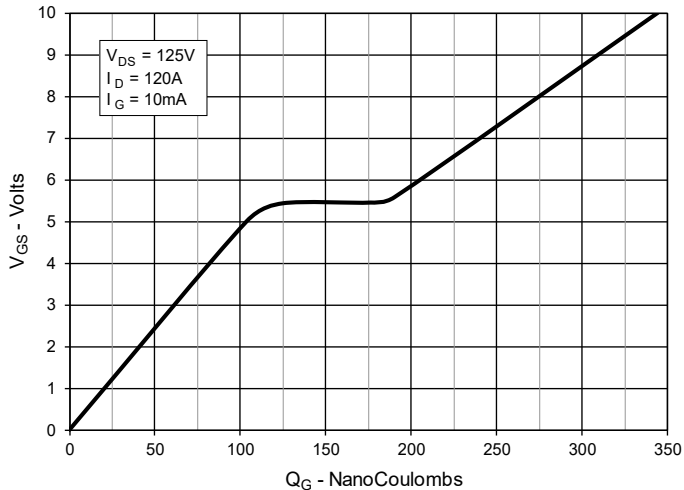
**Fig. 9. Transconductance**



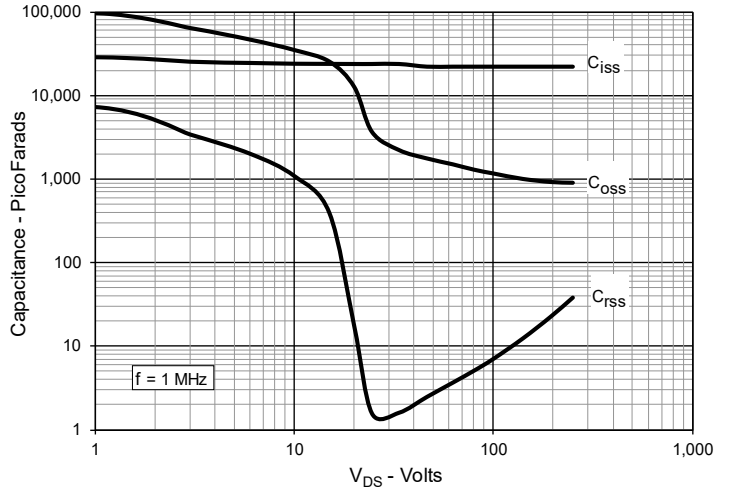
**Fig. 10. Forward Voltage Drop of Intrinsic Diode**



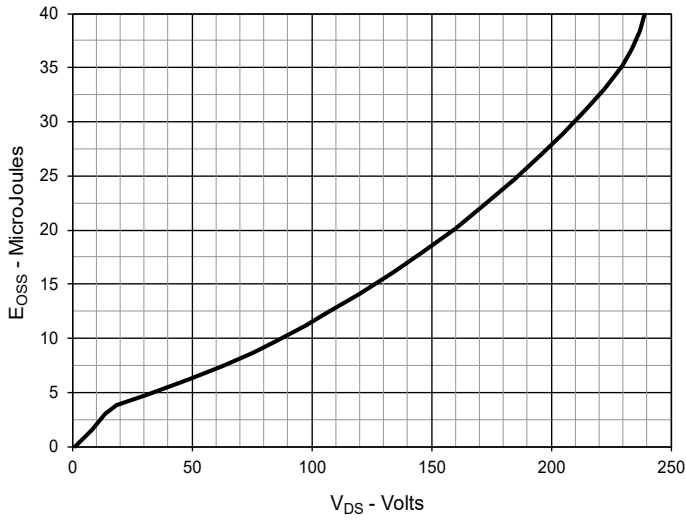
**Fig. 11. Gate Charge**



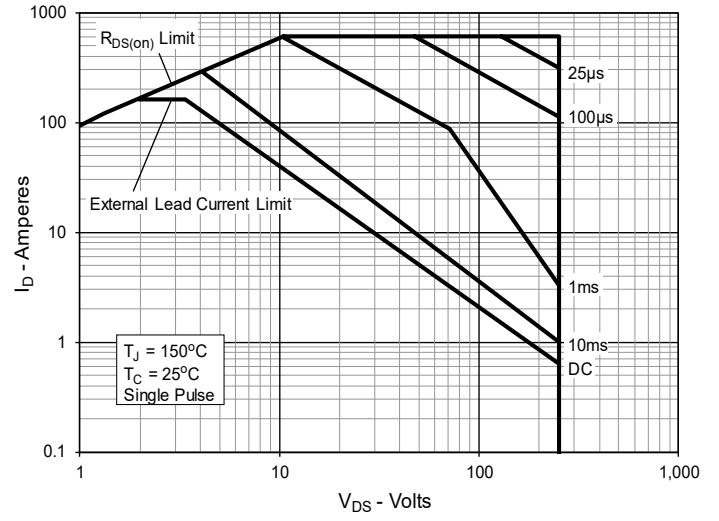
**Fig. 12. Capacitance**



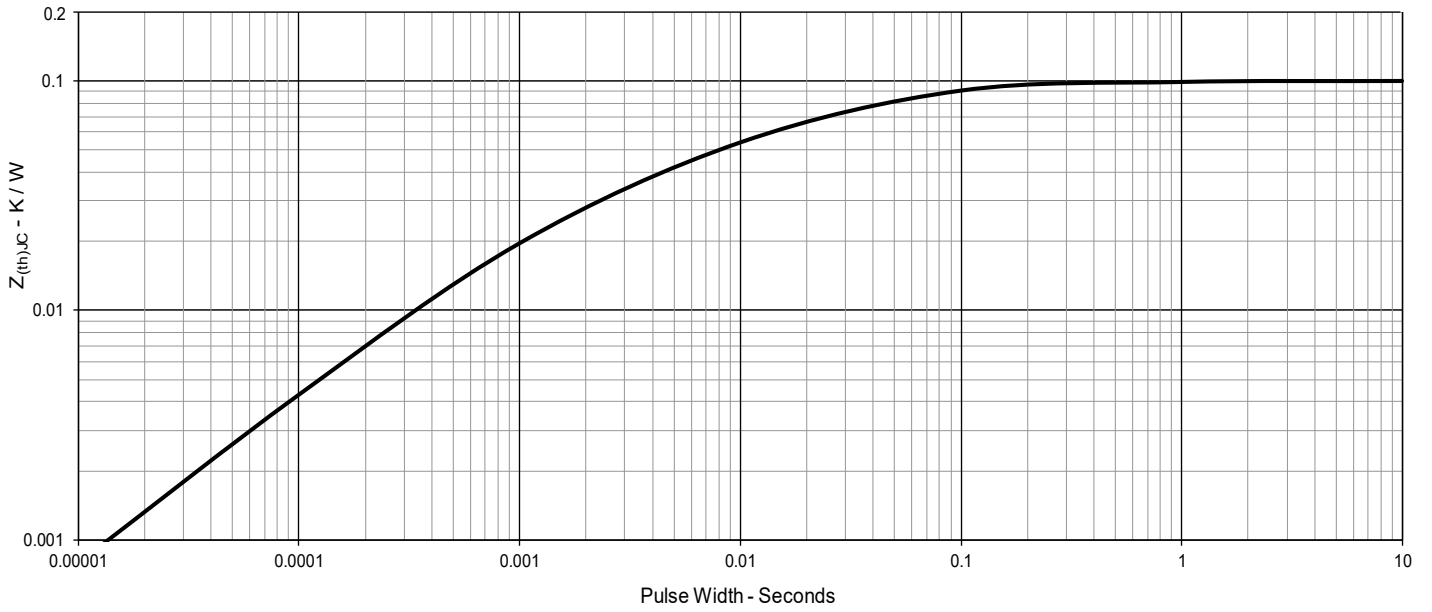
**Fig. 13. Output Capacitance Stored Energy**

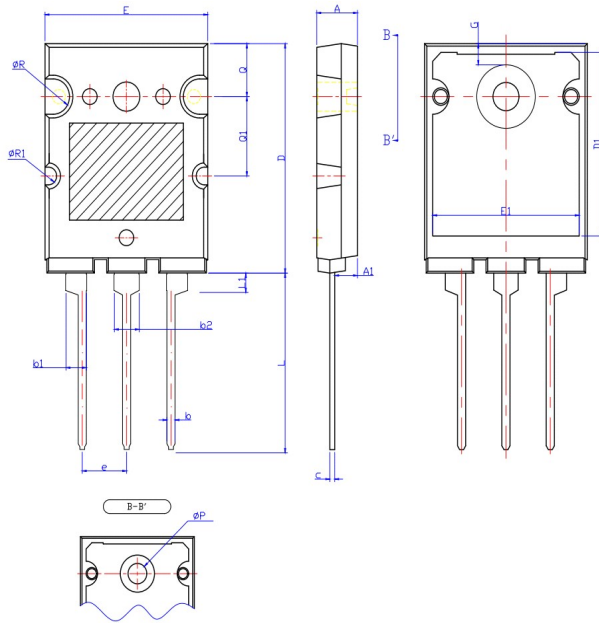


**Fig. 14. Forward-Bias Safe Operating Area**



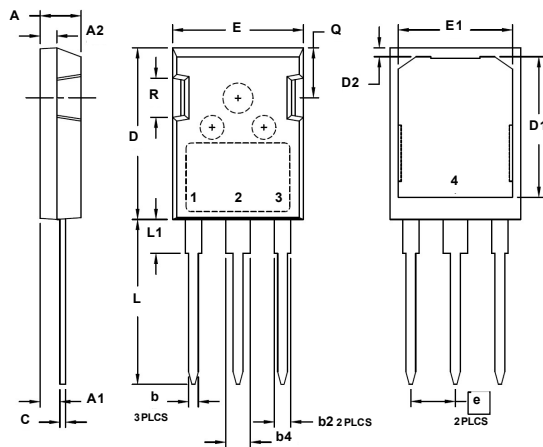
**Fig. 15. Maximum Transient Thermal Impedance**



**TO-264K Outline**


1 - Gate  
 2,4 - Drain  
 3 - Source

SYM	INCHES		MILLIMETERS	
	MIN	MAX	MIN	MAX
A	0.189	0.205	4.80	5.20
A1	0.098	0.122	2.50	3.10
b	0.035	0.049	0.90	1.25
b1	0.091	0.106	2.30	2.70
b2	0.110	0.126	2.80	3.20
c	0.020	0.033	0.50	0.85
D	1.016	1.031	25.80	26.20
E	0.780	0.795	19.80	20.20
e	0.203	0.226	5.15	5.75
L	0.768	0.807	19.50	20.50
L1	0.094	0.102	2.40	2.60
ØP	0.118	0.134	3.00	3.40
Q	0.228	0.244	5.80	6.20
Q1	0.346	0.362	8.80	9.20
E1	0.701	0.717	17.80	18.20
D1	0.811	0.827	20.60	21.00
G	0.087	0.102	2.20	2.60
ØR	0.079		2.00	
ØR1	0.039		1.00	

**PLUS247™ Outline**


1 - Gate  
 2,4 - Drain  
 3 - Source

SYM	INCHES		MILLIMETERS	
	MIN	MAX	MIN	MAX
A	.190	.205	4.83	5.21
A1	.090	.100	2.29	2.54
A2	.075	.085	1.91	2.16
b	.045	.055	1.14	1.40
b2	.075	.087	1.91	2.20
b4	.115	.126	2.92	3.20
C	.024	.031	0.61	0.80
D	.819	.840	20.80	21.34
D1	.650	.690	16.51	17.53
D2	.035	.050	0.89	1.27
E	.620	.635	15.75	16.13
E1	.520	.560	13.08	14.22
e	.215 BSC		5.45 BSC	
L	.780	.810	19.81	20.57
L1	.150	.170	3.81	4.32
Q	.220	.244	5.59	6.20
R	.170	.190	4.32	4.83



---

Disclaimer Notice - Information furnished is believed to be accurate and reliable. However, users should independently evaluate the suitability of and test each product selected for their own applications. Littelfuse products are not designed for, and may not be used in, all applications. Read complete Disclaimer Notice at [www.littelfuse.com/disclaimer-electronics](http://www.littelfuse.com/disclaimer-electronics).

---