

Trench™ Power MOSFET

IXTP60N10TM

$$V_{DSS} = 100V$$

$$I_{D25} = 60A$$

$$R_{DS(on)} \leq 19m\Omega$$

(Electrically Isolated Tab)



N-Channel Enhancement Mode
Avalanche Rated

OVERMOLDED TO-220 W/ FORMED
LEAD (IXTP...M)

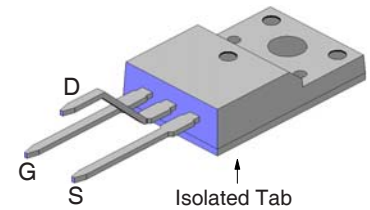

G = Gate D = Drain
S = Source

Symbol	Test Conditions	Maximum Ratings	
V_{DSS}	$T_J = 25^\circ\text{C}$ to 175°C	100	V
V_{DGR}	$T_J = 25^\circ\text{C}$ to 175°C , $R_{GS} = 1M\Omega$	100	V
V_{GSS}	Continuous	± 20	V
V_{GSM}	Transient	± 30	V
I_{D25}	$T_C = 25^\circ\text{C}$, Limited by T_{JM}	60	A
I_{DM}	$T_C = 25^\circ\text{C}$, Pulse Width Limited by T_{JM}	180	A
I_A	$T_C = 25^\circ\text{C}$	10	A
E_{AS}	$T_C = 25^\circ\text{C}$	500	mJ
P_D	$T_C = 25^\circ\text{C}$	60	W
T_J		-55 ... +175	$^\circ\text{C}$
T_{JM}		175	$^\circ\text{C}$
T_{stg}		-55 ... +175	$^\circ\text{C}$
T_L	Maximum Lead Temperature for Soldering	300	$^\circ\text{C}$
T_{SOLD}	1.6 mm (0.062in.) from Case for 10s	260	$^\circ\text{C}$
V_{ISOL}	50/60 Hz, 1 Minute	2500	V~
M_d	Mounting Torque	1.13 / 10	Nm/lb.in
Weight		2.5	g

Features

- Plastic Overmolded tab for Electrical Isolation
- Low $R_{DS(ON)}$
 - for Minimum on-State Conduction Losses
- Fast Switching
- 2500V~ Electrical Isolation

Advantages

- Easy to Mount
- Space Savings
- High Power Density

Applications

- DC-DC Converters
- Battery Chargers
- Switched-Mode and Resonant-Mode Power Supplies
- DC Choppers
- AC Motor Drives
- Uninterruptible Power Supplies
- High Speed Power Switching Applications

Symbol	Test Conditions ($T_J = 25^\circ\text{C}$ Unless Otherwise Specified)	Characteristic Values		
		Min.	Typ.	Max.
BV_{DSS}	$V_{GS} = 0V$, $I_D = 250\mu\text{A}$	100		V
$V_{GS(th)}$	$V_{DS} = V_{GS}$, $I_D = 50\mu\text{A}$	2.5		4.5 V
I_{GSS}	$V_{GS} = \pm 20V$, $V_{DS} = 0V$			± 100 nA
I_{DSS}	$V_{DS} = V_{DSS}$, $V_{GS} = 0V$ $T_J = 150^\circ\text{C}$			1 μA 100 μA
$R_{DS(on)}$	$V_{GS} = 10V$, $I_D = 25A$, Notes 1, 2			19 m Ω

Symbol	Test Conditions $T_J = 25^\circ\text{C}$ Unless Otherwise Specified	Characteristic Values		
		Min.	Typ.	Max.
g_{fs}	$V_{DS} = 10\text{V}, I_D = 0.5 \cdot I_{D25}, \text{ Note 1}$	25	42	S
C_{iss}	$V_{GS} = 0\text{V}, V_{DS} = 25\text{V}, f = 1\text{MHz}$		2650	pF
C_{oss}			335	pF
C_{rss}			60	pF
$t_{d(on)}$	Resistive Switching Times $V_{GS} = 10\text{V}, V_{DS} = 0.5 \cdot V_{DSS}, I_D = 10\text{A}$ $R_G = 15\Omega$ (External)		27	ns
t_r			40	ns
$t_{d(off)}$			43	ns
t_f			37	ns
$Q_{g(on)}$		$V_{GS} = 10\text{V}, V_{DS} = 0.5 \cdot V_{DSS}, I_D = 10\text{A}$		49
Q_{gs}			15	nC
Q_{gd}			11	nC
R_{thJC}				2.5 $^\circ\text{C/W}$

Source-Drain Diode

Symbol	Test Conditions $T_J = 25^\circ\text{C}$ Unless Otherwise Specified	Characteristic Values		
		Min.	Typ.	Max.
I_S	$V_{GS} = 0\text{V}$			60 A
I_{SM}	Repetitive, Pulse Width Limited by T_{JM}			240 A
V_{SD}	$I_F = 25\text{A}, V_{GS} = 0\text{V}, \text{ Note 1}$			1.2 V
t_{rr}	$I_F = 30\text{A}, V_{GS} = 0\text{V}$ $-di/dt = 100\text{A}/\mu\text{s}$ $V_R = 50\text{V}$		59	ns
I_{RM}			3.8	A
Q_{RM}			112	nC

- Notes
1. Pulse test, $t \leq 300 \mu\text{s}$; duty cycle, $d \leq 2\%$.
 2. On through-hole packages, $R_{DS(on)}$ Kelvin test contact location must be 5mm or less from the package body.

OVERMOLDED TO-220 W/ FORMED LEAD (IXTP...M)

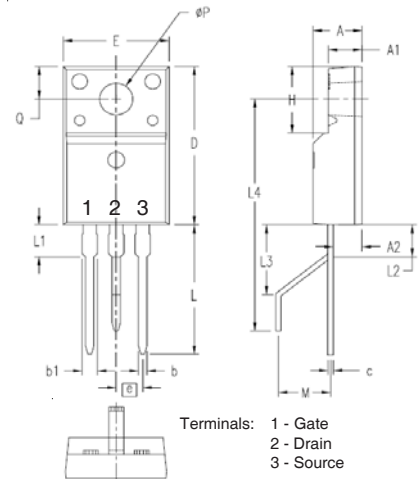

SYM	INCHES		MILLIMETERS	
	MIN	MAX	MIN	MAX
A	.177	.193	4.50	4.90
A1	.092	.108	2.34	2.74
A2	.101	.117	2.56	2.96
b	.028	.035	0.70	0.90
b1	.050	.058	1.27	1.47
c	.016	.024	0.40	0.60
D	.617	.633	15.67	16.07
E	.392	.408	9.96	10.36
e	.100 BSC		2.54 BSC	
H	.255	.271	6.48	6.88
L	.500	.523	12.70	13.30
L1	.119	.135	3.03	3.43
L2	.098	.138	2.50	3.50
L3	.256	.295	6.50	7.50
L4	.906	.945	23.00	24.00
M	.177	.216	4.50	5.50
∅P	.121	.129	3.08	3.28
Q	.126	.134	3.20	3.40

PRELIMINARY TECHNICAL INFORMATION

The product presented herein is under development. The Technical Specifications offered are derived from data gathered during objective characterizations of preliminary engineering lots; but also may yet contain some information supplied during a pre-production design evaluation. IXYS reserves the right to change limits, test conditions, and dimensions without notice.

IXYS reserves the right to change limits, test conditions, and dimensions.

IXYS MOSFETs and IGBTs are covered by one or more of the following U.S. patents:

4,835,592	4,931,844	5,049,961	5,237,481	6,162,665	6,404,065 B1	6,683,344	6,727,585	7,005,734 B2	7,157,338B2
4,860,072	5,017,508	5,063,307	5,381,025	6,259,123 B1	6,534,343	6,710,405 B2	6,759,692	7,063,975 B2	
4,881,106	5,034,796	5,187,117	5,486,715	6,306,728 B1	6,583,505	6,710,463	6,771,478 B2	7,071,537	

Fig. 1. Output Characteristics @ $T_J = 25^\circ\text{C}$

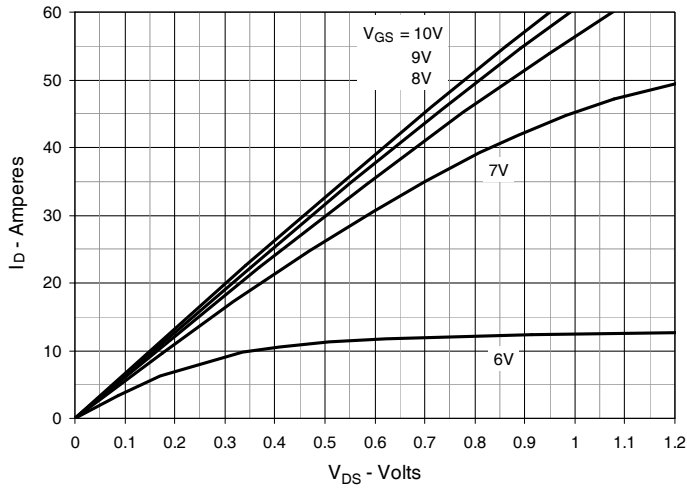

Fig. 2. Extended Output Characteristics @ $T_J = 25^\circ\text{C}$

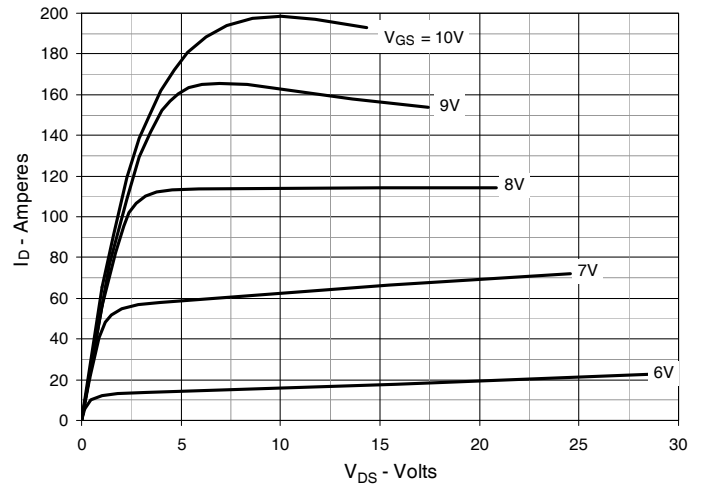

Fig. 3. Output Characteristics @ $T_J = 150^\circ\text{C}$

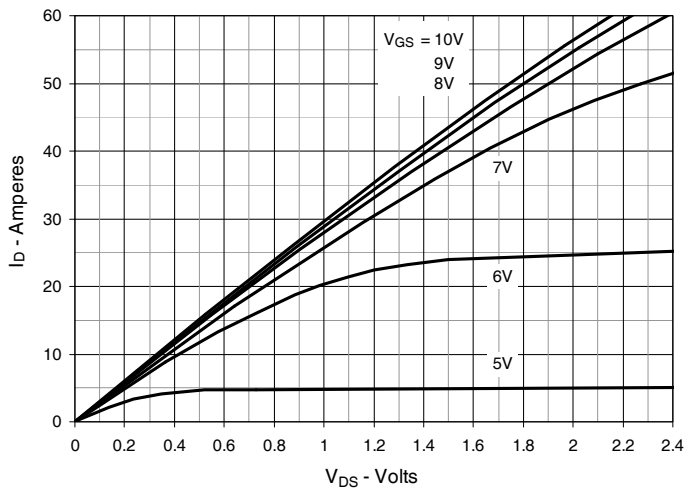

Fig. 4. $R_{DS(on)}$ Normalized to $I_D = 30\text{A}$ Value vs. Junction Temperature

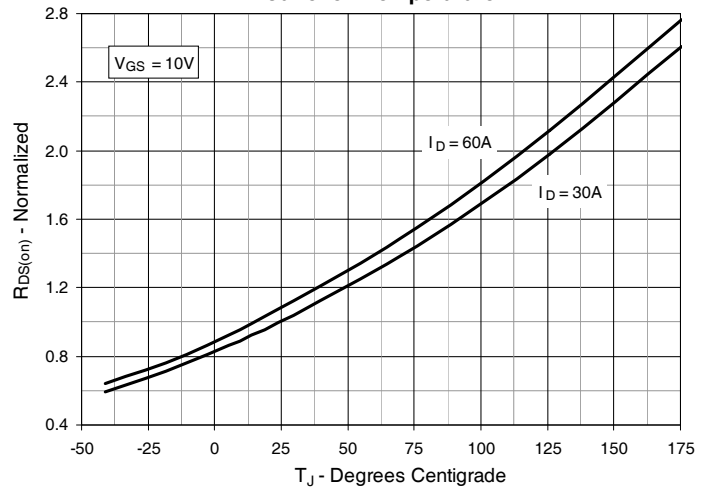

Fig. 5. $R_{DS(on)}$ Normalized to $I_D = 30\text{A}$ Value vs. Drain Current

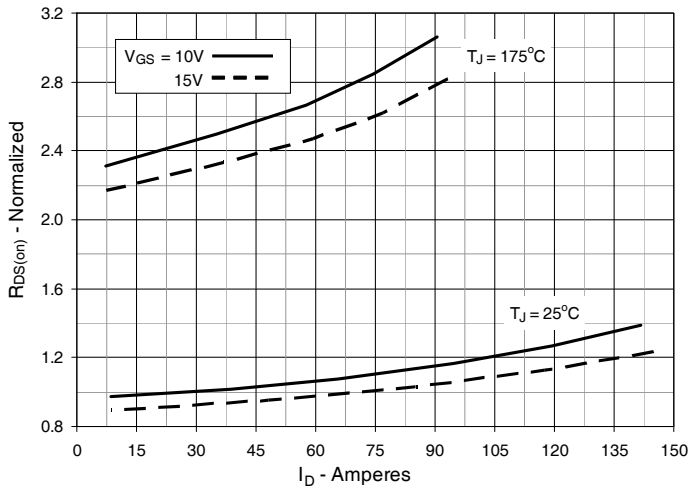

Fig. 6. Input Admittance

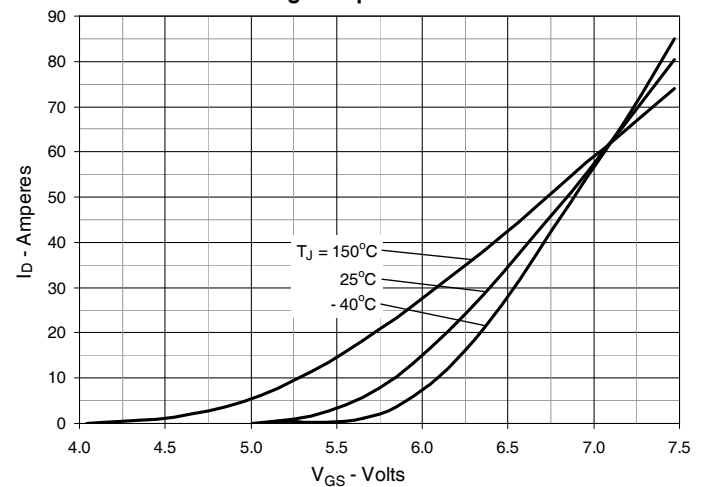

Fig. 7. Transconductance

Fig. 8. Forward Voltage Drop of Intrinsic Diode

Fig. 9. Gate Charge

Fig. 10. Capacitance

Fig. 11. Maximum Transient Thermal Impedance

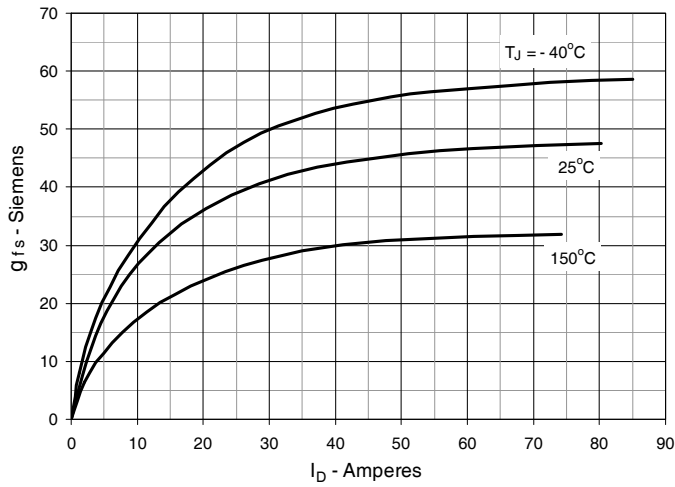
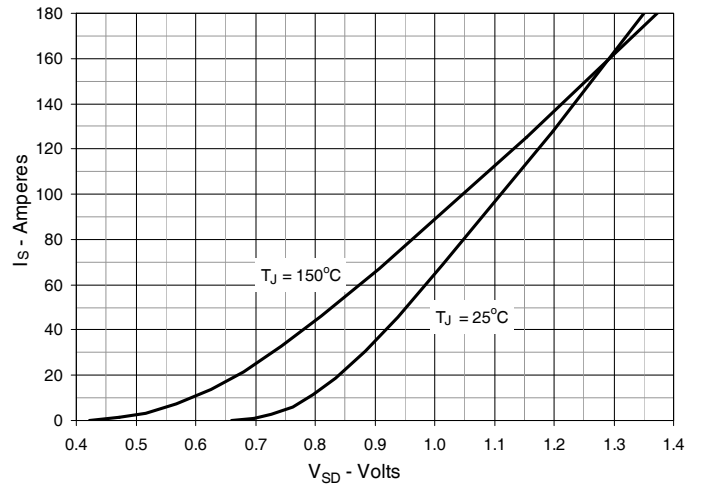
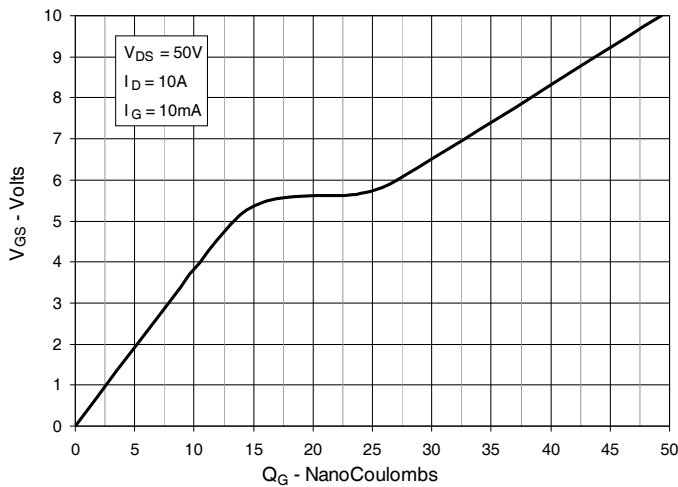
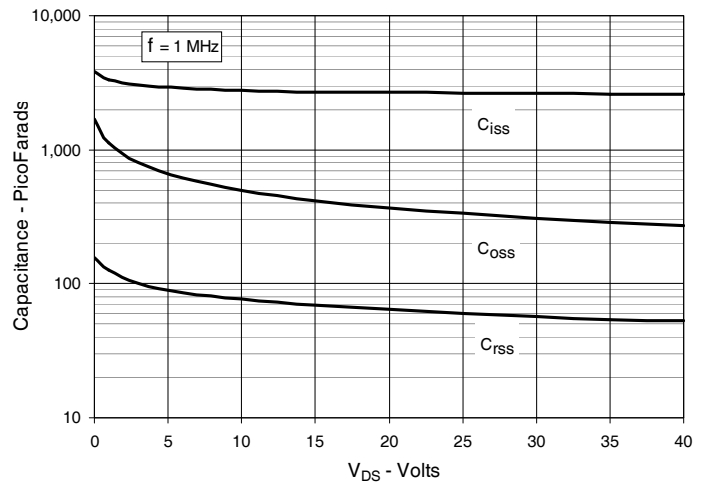
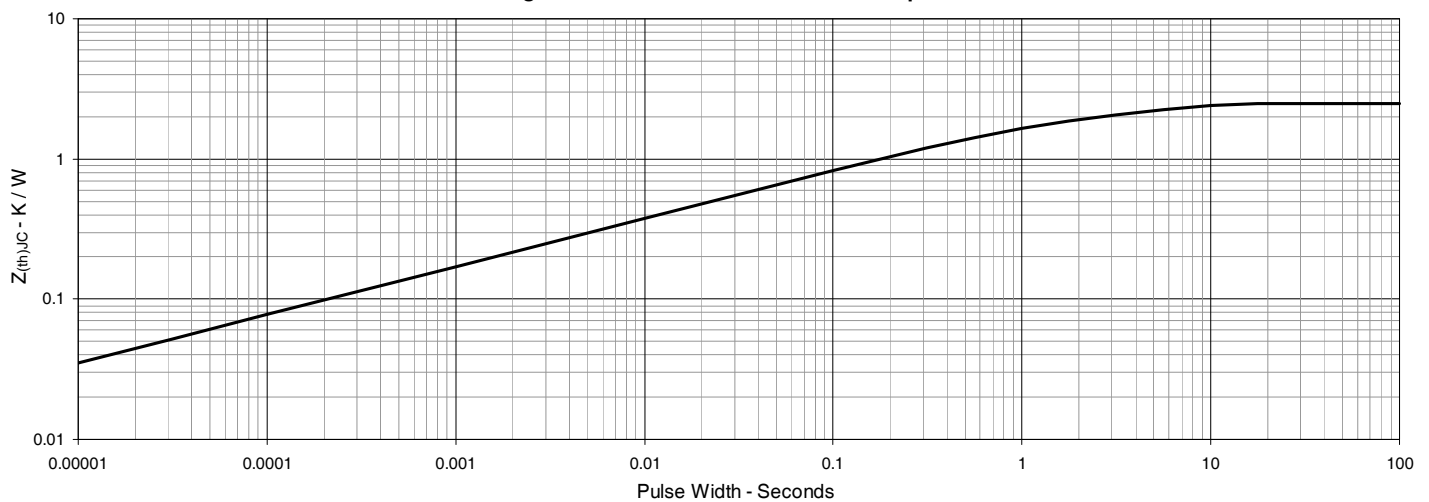
Fig. 12. Resistive Turn-on Rise Time vs. Junction Temperature

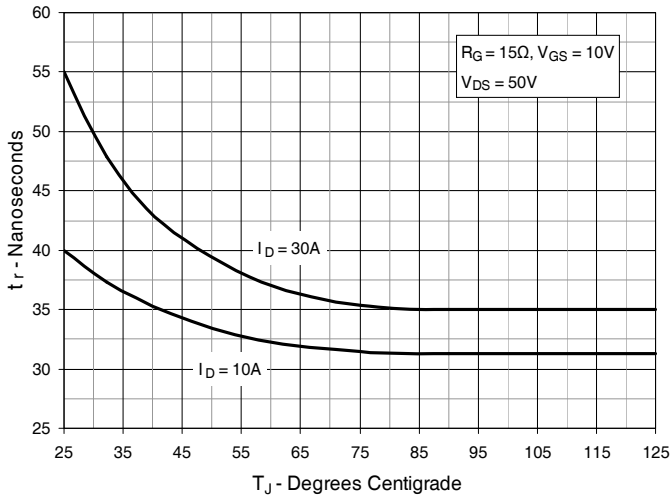

Fig. 13. Resistive Turn-on Rise Time vs. Drain Current

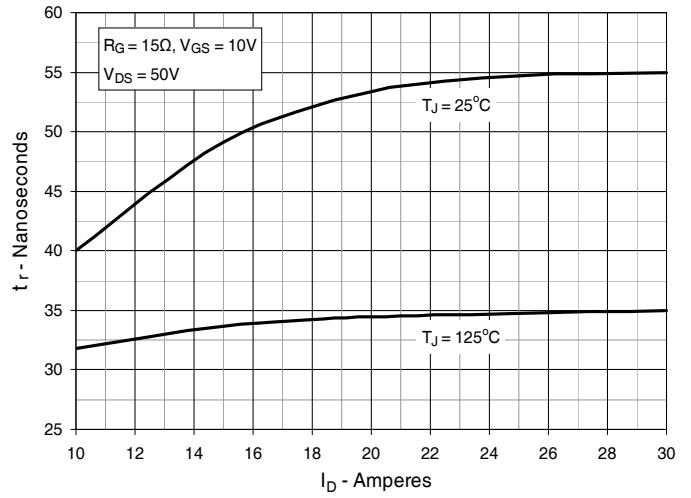

Fig. 14. Resistive Turn-on Switching Times vs. Gate Resistance

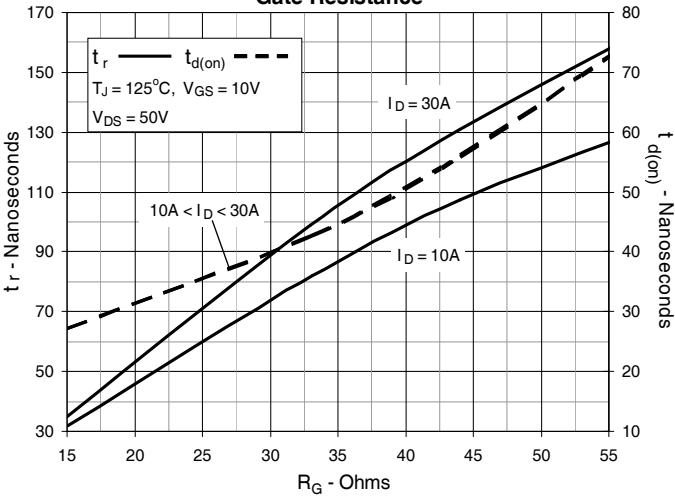

Fig. 15. Resistive Turn-off Switching Times vs. Junction Temperature

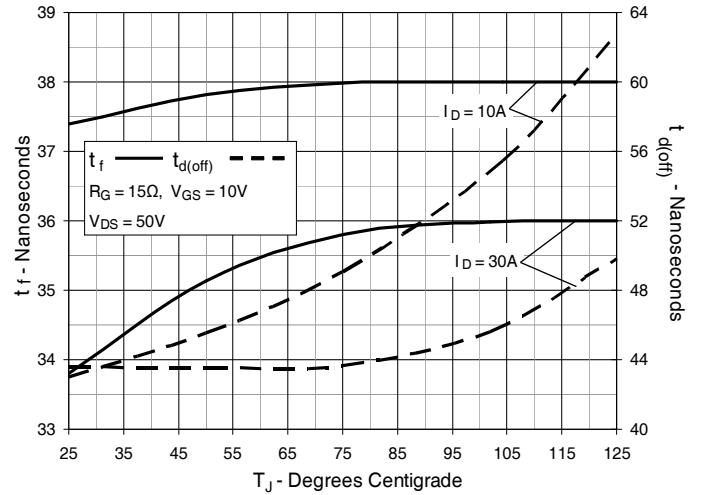

Fig. 16. Resistive Turn-off Switching Times vs. Drain Current

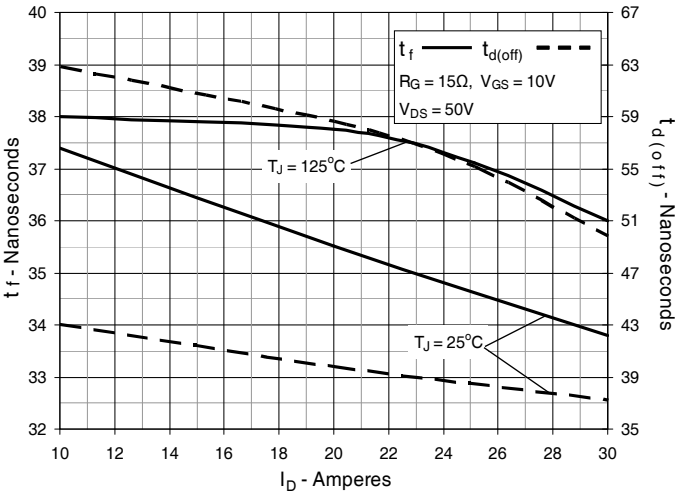
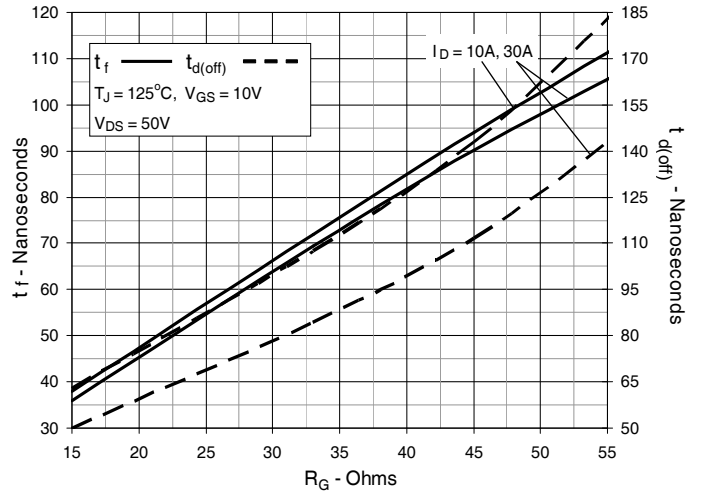

Fig. 17. Resistive Turn-off Switching Times vs. Gate Resistance





Disclaimer Notice - Information furnished is believed to be accurate and reliable. However, users should independently evaluate the suitability of and test each product selected for their own applications. Littelfuse products are not designed for, and may not be used in, all applications. Read complete Disclaimer Notice at www.littelfuse.com/disclaimer-electronics.