

TrenchHV™ Power MOSFET

IXTH160N15T

$$V_{DSS} = 150 \text{ V}$$

$$I_{D25} = 160 \text{ A}$$

$$R_{DS(on)} \leq 9.6 \text{ m}\Omega$$

N-Channel Enhancement Mode
Avalanche Rated

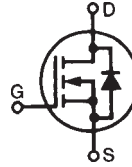

Symbol	Test Conditions	Maximum Ratings	
V_{DSS}	$T_J = 25^\circ\text{C}$ to 175°C	150	V
V_{DGR}	$T_J = 25^\circ\text{C}$ to 175°C ; $R_{GS} = 1\text{M}\Omega$	150	V
V_{GSM}	Transient	± 30	V
I_{D25}	$T_C = 25^\circ\text{C}$	160	A
I_{LRMS}	Lead Current Limit, RMS	75	A
I_{DM}	$T_C = 25^\circ\text{C}$, pulse width limited by T_{JM}	430	A
I_A	$T_C = 25^\circ\text{C}$	5	A
E_{AS}	$T_C = 25^\circ\text{C}$	1.0	J
dv/dt	$I_S \leq I_{DM}$, $V_{DD} \leq V_{DSS}$, $T_J \leq 175^\circ\text{C}$	10	V/ns
P_d	$T_C = 25^\circ\text{C}$	830	W
T_J		-55 ... +175	$^\circ\text{C}$
T_{JM}		175	$^\circ\text{C}$
T_{stg}		-55 ... +175	$^\circ\text{C}$
T_L	1.6 mm (0.062 in.) from case for 10s	300	$^\circ\text{C}$
T_{SOLD}	Plastic body for 10 seconds	260	$^\circ\text{C}$
M_d	Mounting torque	1.13 / 10	Nm/lb.in.
Weight		6	g

TO-247

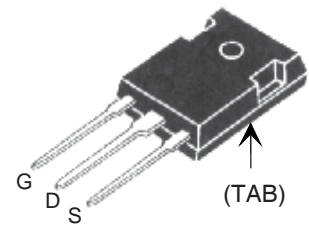

G = Gate D = Drain
S = Source TAB = Drain

Symbol	Test Conditions ($T_J = 25^\circ\text{C}$ unless otherwise specified)	Characteristic Values		
		Min.	Typ.	Max.
BV_{DSS}	$V_{GS} = 0 \text{ V}$, $I_D = 250 \mu\text{A}$	150		V
$V_{GS(th)}$	$V_{DS} = V_{GS}$, $I_D = 1 \text{ mA}$	2.5		V
I_{GSS}	$V_{GS} = \pm 20 \text{ V}$, $V_{DS} = 0 \text{ V}$			$\pm 200 \text{ nA}$
I_{DSS}	$V_{DS} = V_{DSS}$			25 μA
	$V_{GS} = 0 \text{ V}$ $T_J = 150^\circ\text{C}$			300 μA
$R_{DS(on)}$	$V_{GS} = 10 \text{ V}$, $I_D = 0.5 \cdot I_{D25}$, Note 1	8.0	9.6	$\text{m}\Omega$

Features

- Unclamped Inductive Switching (UIS) rated
- Low package inductance
 - easy to drive and to protect
- 175 $^\circ\text{C}$ Operating Temperature

Advantages

- Easy to mount
- Space savings
- High power density

Symbol	Test Conditions	Characteristic Values		
		Min.	Typ.	Max.
$(T_J = 25^\circ\text{C}$ unless otherwise specified)				
g_{fs}	$V_{DS} = 10\text{V}; I_D = 0.5 \cdot I_{D25}$, Note 1	65	105	S
C_{iss}	$V_{GS} = 0\text{V}, V_{DS} = 25\text{V}, f = 1\text{ MHz}$		8800	pF
C_{oss}			1170	pF
C_{rss}			150	pF
Resistive Switching Times				
$t_{d(on)}$	$V_{GS} = 15\text{V}, V_{DS} = 0.5 \cdot V_{DSS}, I_D = 0.5 I_{D25}$ $R_G = 2.0\Omega$ (External)		21	ns
t_r			21	ns
$t_{d(off)}$			60	ns
t_f			31	ns
$Q_{g(on)}$	$V_{GS} = 10\text{V}, V_{DS} = 0.5 \cdot V_{DSS}, I_D = 25\text{A}$		160	nC
Q_{gs}			43	nC
Q_{gd}			46	nC
R_{thJC}			0.18	$^\circ\text{C/W}$
R_{thCS}		0.21		$^\circ\text{C/W}$

Source-Drain Diode

Symbol	Test Conditions	Characteristic Values		
		Min.	Typ.	Max.
$T_J = 25^\circ\text{C}$ unless otherwise specified)				
I_S	$V_{GS} = 0\text{V}$			160 A
I_{SM}	Pulse width limited by T_{JM}			430 A
V_{SD}	$I_F = 50\text{A}, V_{GS} = 0\text{V}$, Note 1			1.2 V
t_{rr}	$I_F = 80\text{A}, -di/dt = 200\text{A}/\mu\text{s}$ $V_R = 75\text{V}, V_{GS} = 0\text{V}$		115	ns

Notes: 1. Pulse test, $t \leq 300\text{ ms}$, duty cycle, $d \leq 2\%$

TO-247AD Outline

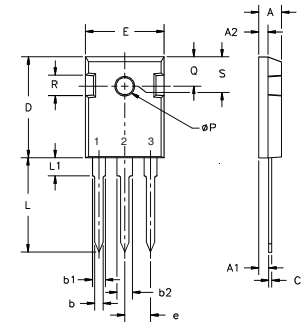

Terminals: 1 - Gate
2 - Drain
3 - Source
A1 - Tab - Drain

Dim.	Millimeter		Inches	
	Min.	Max.	Min.	Max.
A	4.7	5.3	.185	.209
A ₁	2.2	2.54	.087	.102
A ₂	2.2	2.6	.059	.098
b	1.0	1.4	.040	.055
b ₁	1.65	2.13	.065	.084
b ₂	2.87	3.12	.113	.123
C	.4	.8	.016	.031
D	20.80	21.46	.819	.845
E	15.75	16.26	.610	.640
e	5.20	5.72	0.205	0.225
L	19.81	20.32	.780	.800
L1		4.50		.177
ÆP	3.55	3.65	.140	.144
Q	5.89	6.40	0.232	0.252
R	4.32	5.49	.170	.216
S	6.15	BSC	242	BSC

PRELIMINARY TECHNICAL INFORMATION

The product presented herein is under development. The Technical Specifications offered are derived from data gathered during objective characterizations of preliminary engineering lots; but also may yet contain some information supplied during a pre-production design evaluation. IXYS reserves the right to change limits, test conditions, and dimensions without notice.

IXYS reserves the right to change limits, test conditions, and dimensions.

IXYS MOSFETs and IGBTs are covered by one or more of the following U.S. patents:

4,835,592	4,931,844	5,049,961	5,237,481	6,162,665	6,404,065 B1	6,683,344	6,727,585	7,005,734 B2	7,157,338 B2
4,850,072	5,017,508	5,063,307	5,381,025	6,259,123 B1	6,534,343	6,710,405 B2	6,759,692	7,063,975 B2	
4,881,106	5,034,796	5,187,117	5,486,715	6,306,728 B1	6,583,505	6,710,463	6,771,478 B2	7,071,537	

Fig. 1. Output Characteristics @ 25°C

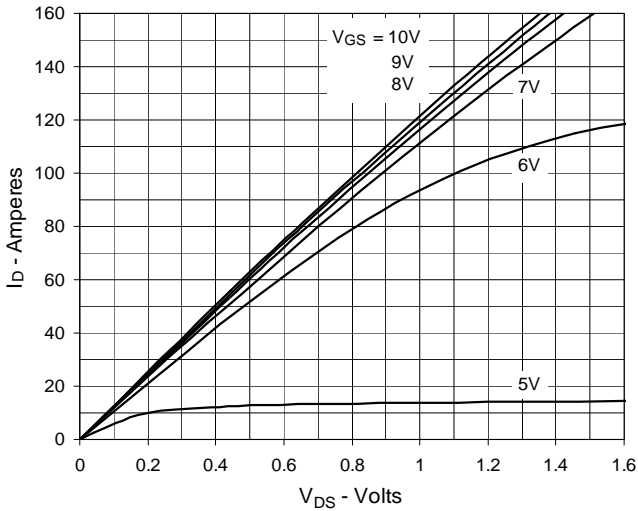

Fig. 2. Extended Output Characteristics @ 25°C

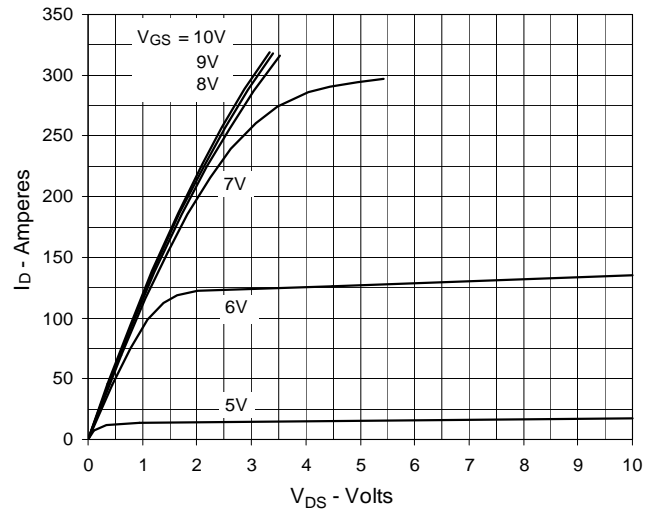

Fig. 3. Output Characteristics @ 150°C

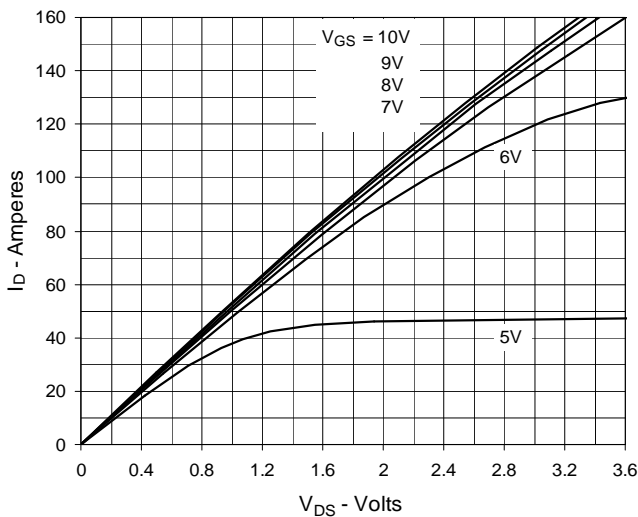

Fig. 4. $R_{DS(on)}$ Normalized to $I_D = 80A$ Value vs. Junction Temperature

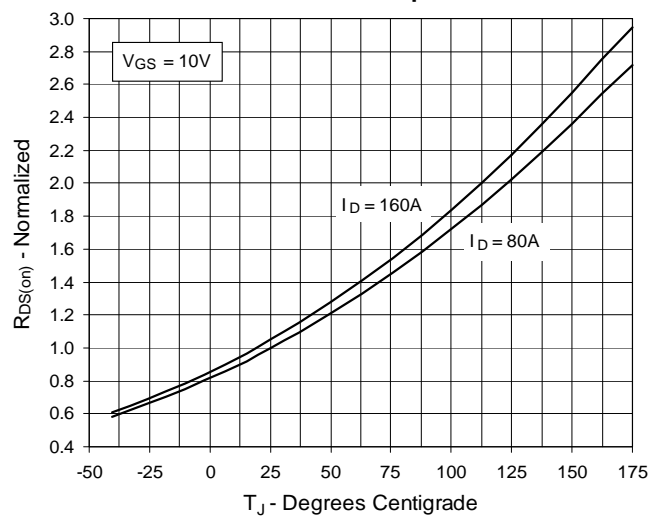

Fig. 5. $R_{DS(on)}$ Normalized to $I_D = 80A$ Value vs. Drain Current

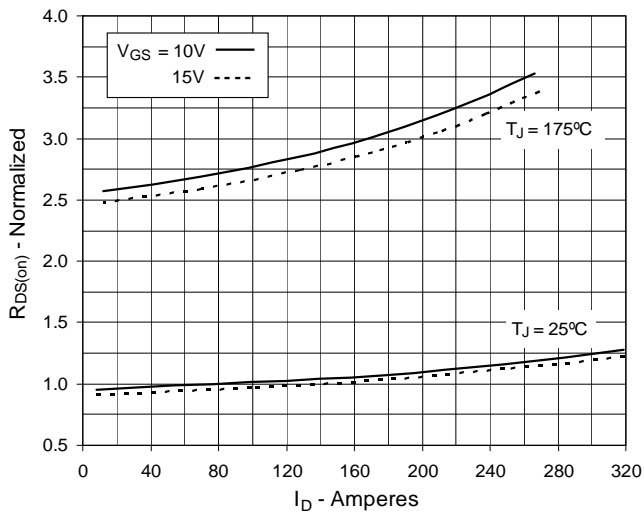

Fig. 6. Drain Current vs. Case Temperature

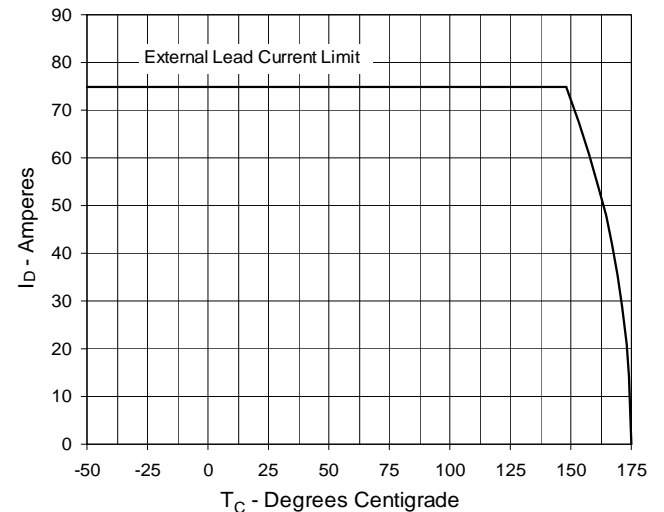

Fig. 7. Input Admittance

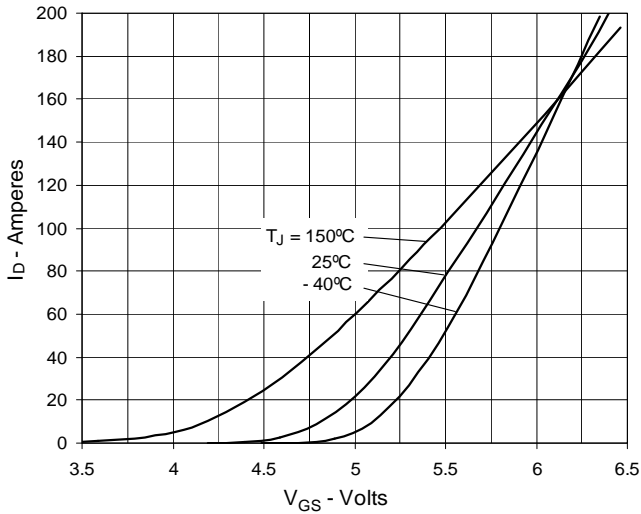

Fig. 8. Transconductance

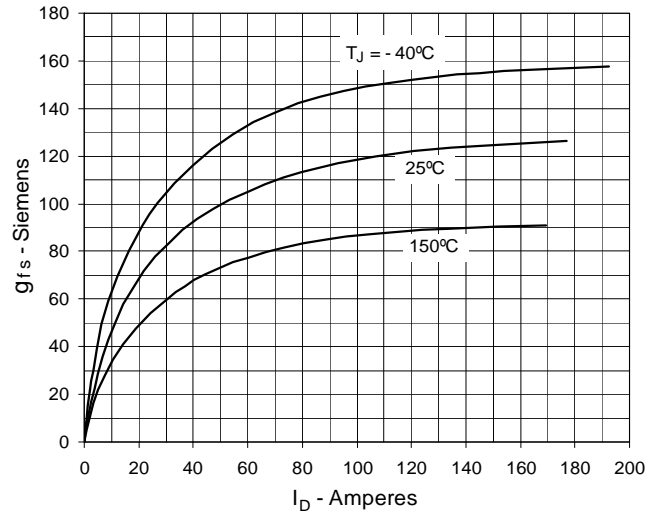

Fig. 9. Forward Voltage Drop of Intrinsic Diode

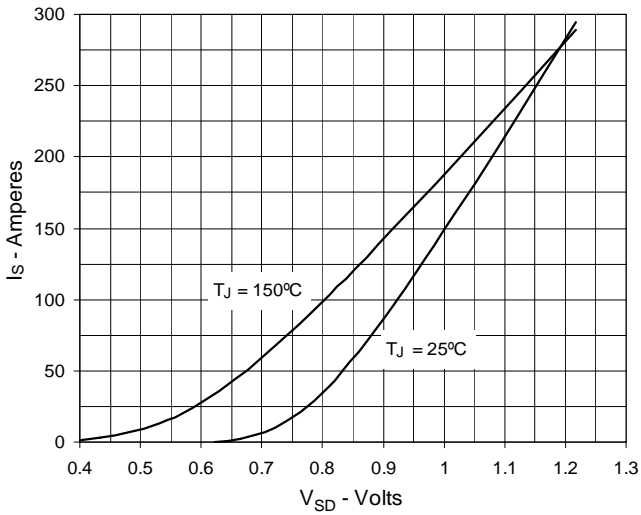

Fig. 10. Gate Charge

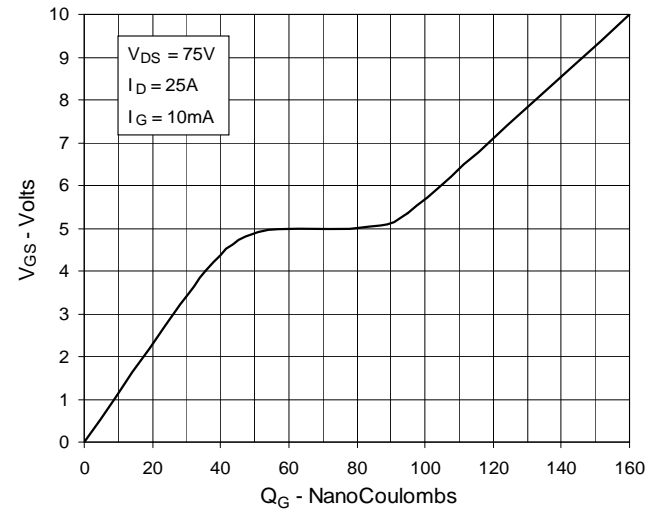

Fig. 11. Capacitance

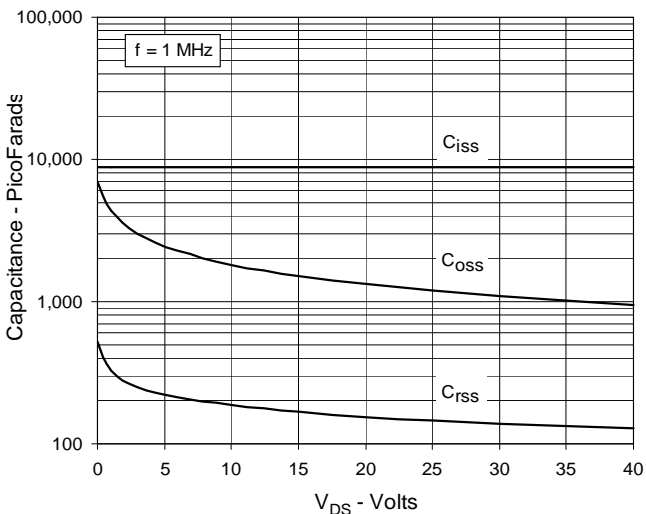

Fig. 12. Maximum Transient Thermal Impedance

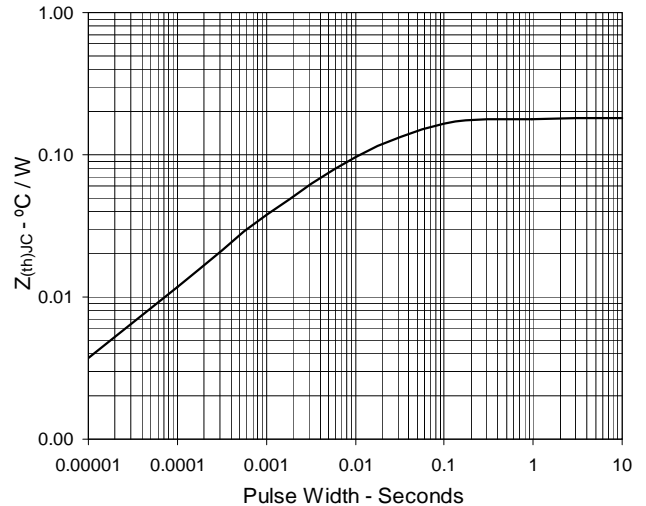

Fig. 13. Resistive Turn-on Rise Time vs. Junction Temperature

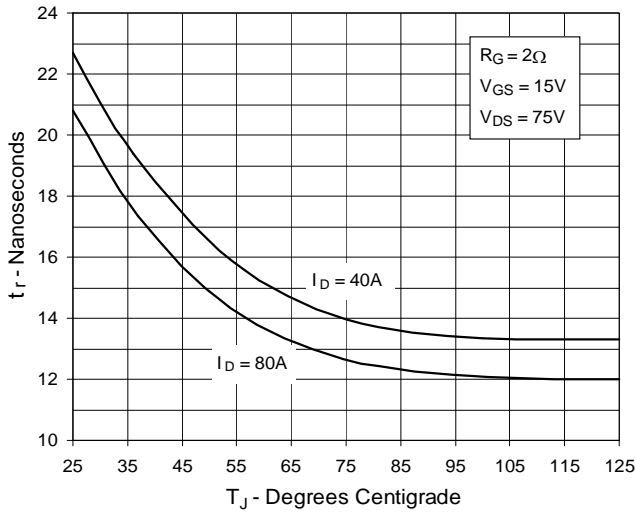

Fig. 14. Resistive Turn-on Rise Time vs. Drain Current

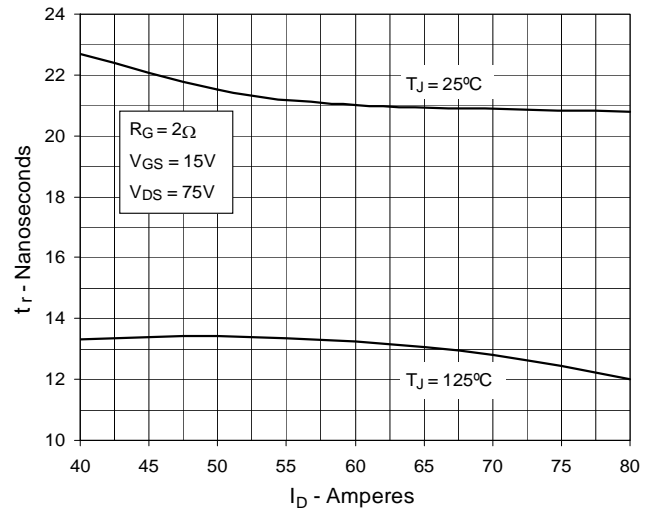

Fig. 15. Resistive Turn-on Switching Times vs. Gate Resistance

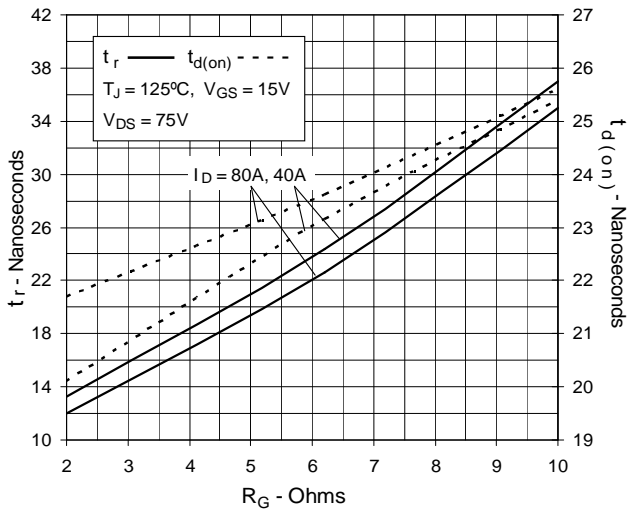

Fig. 16. Resistive Turn-off Switching Times vs. Junction Temperature

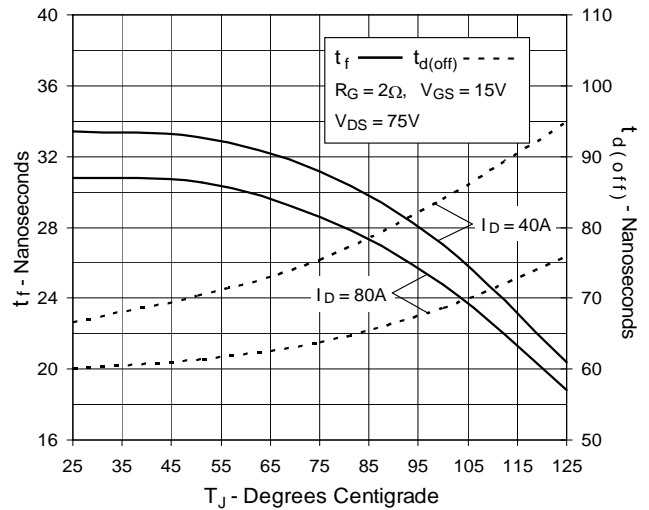

Fig. 17. Resistive Turn-off Switching Times vs. Drain Current

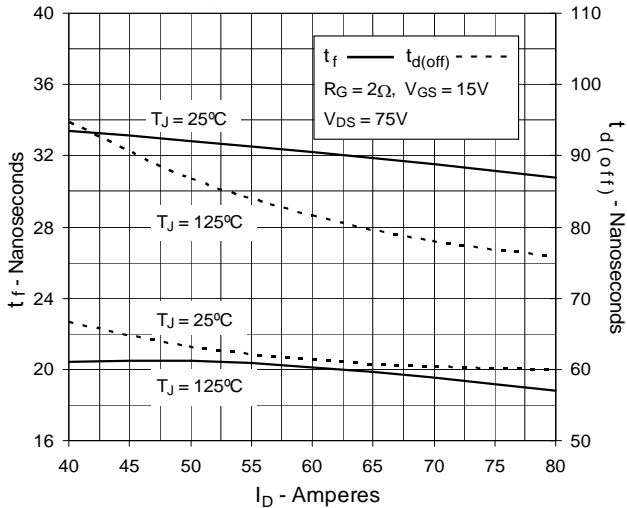
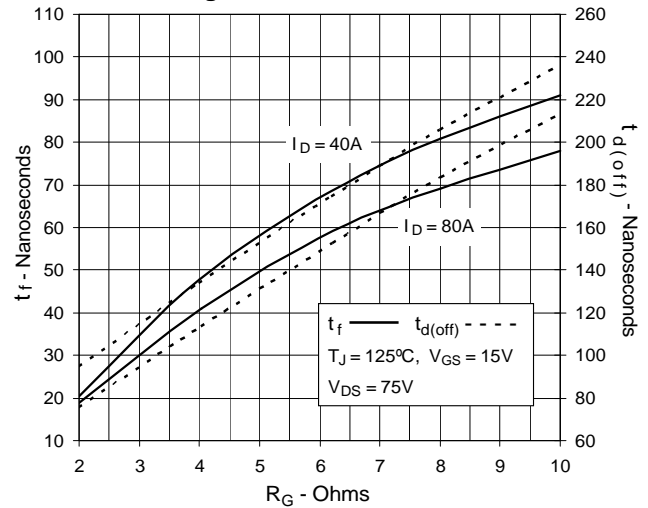

Fig. 18. Resistive Turn-off Switching Times vs. Gate Resistance





Disclaimer Notice - Information furnished is believed to be accurate and reliable. However, users should independently evaluate the suitability of and test each product selected for their own applications. Littelfuse products are not designed for, and may not be used in, all applications. Read complete Disclaimer Notice at www.littelfuse.com/disclaimer-electronics.