

Trench™ Power MOSFET

IXTA48N20T
IXTP48N20T
IXTQ48N20T

V_{DSS} = 200V
I_{D25} = 48A
R_{DS(on)} ≤ 50mΩ

N-Channel Enhancement Mode
Avalanche Rated
Fast Intrinsic Rectifier



Symbol	Test Conditions	Maximum Ratings	
V _{DSS}	T _J = 25°C to 175°C	200	V
V _{DGR}	T _J = 25°C to 175°C, R _{GS} = 1MΩ	200	V
V _{GSM}	Transient	± 30	V
I _{D25}	T _C = 25°C	48	A
I _{DM}	T _C = 25°C, Pulse Width Limited by T _{JM}	130	A
I _A	T _C = 25°C	5	A
E _{AS}	T _C = 25°C	500	mJ
dv/dt	I _S ≤ I _{DM} , V _{DD} ≤ V _{DSS} , T _J ≤ 175°C	3	V/ns
P _D	T _C = 25°C	250	W
T _J		-55 ... +175	°C
T _{JM}		175	°C
T _{stg}		-55 ... +175	°C
T _L	1.6mm (0.062in.) from Case for 10s	300	°C
T _{SOLD}	Plastic Body for 10 seconds	260	°C
F _C	Mounting Force (TO-263)	10..65/2.2..14.6	Nm/lb.in
M _d	Mounting Torque (TO-220 & TO-3P)	1.13/10	Nm/lb.in
Weight	TO-263	2.5	g
	TO-220	3.0	g
	TO-3P	5.5	g

Symbol	Test Conditions (T _J = 25°C, Unless Otherwise Specified)	Characteristic Values		
		Min.	Typ.	Max.
BV _{DSS}	V _{GS} = 0V, I _D = 250μA	200		V
V _{GS(th)}	V _{DS} = V _{GS} , I _D = 250μA	2.5		4.5 V
I _{GSS}	V _{GS} = ± 20V, V _{DS} = 0V			± 100 nA
I _{DSS}	V _{DS} = V _{DSS} , V _{GS} = 0V T _J = 150°C			5 μA 250 μA
R _{DS(on)}	V _{GS} = 10V, I _D = 0.5 • I _{D25} , Note 1		40	50 mΩ

TO-263 AA (IXTA)

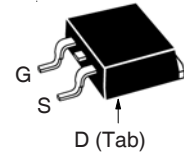

TO-220AB (IXTP)

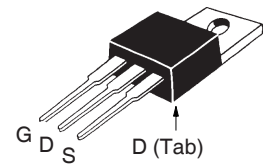

TO-3P (IXTQ)

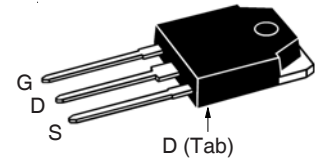

G = Gate D = Drain
S = Source Tab = Drain

Features

- High Current Handling Capability
- Avalanche Rated
- Fast Intrinsic Rectifier
- Low R_{DS(on)}

Advantages

- Easy to Mount
- Space Savings
- High Power Density

Applications

- DC-DC Converters
- Battery Chargers
- Switch-Mode and Resonant-Mode Power Supplies
- DC Choppers
- AC Motor Drives
- Uninterruptible Power Supplies
- High Speed Power Switching Applications

Symbol	Test Conditions ($T_J = 25^\circ\text{C}$, Unless Otherwise Specified)	Characteristic Values		
		Min.	Typ.	Max.
g_{fs}	$V_{DS} = 10\text{V}$, $I_D = 0.5 \cdot I_{D25}$, Note 1	26	44	S
C_{iss}	$V_{GS} = 0\text{V}$, $V_{DS} = 25\text{V}$, $f = 1\text{MHz}$		3090	pF
C_{oss}			350	pF
C_{rss}			40	pF
$t_{d(on)}$	Resistive Switching Times $V_{GS} = 10\text{V}$, $V_{DS} = 0.5 \cdot V_{DSS}$, $I_D = 0.5 \cdot I_{D25}$ $R_G = 10\Omega$ (External)		20	ns
t_r			26	ns
$t_{d(off)}$			46	ns
t_f			28	ns
$Q_{g(on)}$	$V_{GS} = 10\text{V}$, $V_{DS} = 0.5 \cdot V_{DSS}$, $I_D = 0.5 \cdot I_{D25}$		60	nC
Q_{gs}			18	nC
Q_{gd}			13	nC
R_{thJC}			0.50	$^\circ\text{C/W}$
R_{thCS}	TO-220		0.50	$^\circ\text{C/W}$
R_{thCS}	TO-3P		0.25	$^\circ\text{C/W}$

Source-Drain Diode

Symbol	Test Conditions ($T_J = 25^\circ\text{C}$, Unless Otherwise Specified)	Characteristic Values		
		Min.	Typ.	Max.
I_S	$V_{GS} = 0\text{V}$			48 A
I_{SM}	Repetitive, Pulse Width Limited by T_{JM}			192 A
V_{SD}	$I_F = 48\text{A}$, $V_{GS} = 0\text{V}$, Note 1			1.2 V
t_{rr}	$I_F = 0.5 \cdot I_{D25}$, $V_{GS} = 0\text{V}$ $-di/dt = 100\text{A}/\mu\text{s}$ $V_R = 0.5 \cdot V_{DSS}$		130	ns
I_{RM}			8.5	A
Q_{RM}			550	nC

Note: 1. Pulse test, $t \leq 300\mu\text{s}$, duty cycle, $d \leq 2\%$.

TO-263 (IXTA) Outline

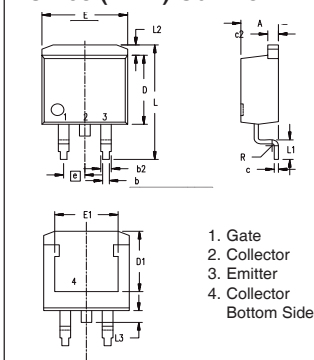

Dim.	Millimeter		Inches	
	Min.	Max.	Min.	Max.
A	4.06	4.83	.160	.190
b	0.51	0.99	.020	.039
b2	1.14	1.40	.045	.055
c	0.40	0.74	.016	.029
c2	1.14	1.40	.045	.055
D	8.64	9.65	.340	.380
D1	8.00	8.89	.280	.320
E	9.65	10.41	.380	.405
E1	6.22	8.13	.270	.320
e	2.54	BSC	.100	BSC
L	14.61	15.88	.575	.625
L1	2.29	2.79	.090	.110
L2	1.02	1.40	.040	.055
L3	1.27	1.78	.050	.070
L4	0	0.13	0	.005

1. Gate
 2. Collector
 3. Emitter
 4. Collector
- Bottom Side

TO-220 (IXTP) Outline

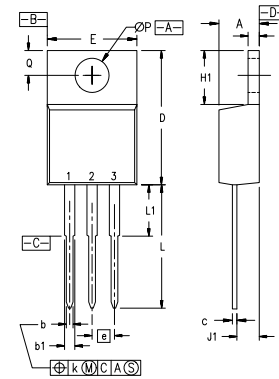

- Pins: 1 - Gate 2 - Drain
3 - Source

SYM	INCHES		MILLIMETERS	
	MIN	MAX	MIN	MAX
A	.170	.190	4.32	4.83
b	.025	.040	0.64	1.02
b1	.045	.065	1.15	1.65
c	.014	.022	0.35	0.56
D	.580	.630	14.73	16.00
E	.390	.420	9.91	10.66
e	.100	BSC	2.54	BSC
F	.045	.055	1.14	1.40
H1	.230	.270	5.85	6.85
J1	.090	.110	2.29	2.79
k	0	.015	0	0.38
L	.500	.550	12.70	13.97
L1	.110	.230	2.79	5.84
ØP	.139	.161	3.53	4.08
Q	.100	.125	2.54	3.18

TO-3P (IXTQ) Outline

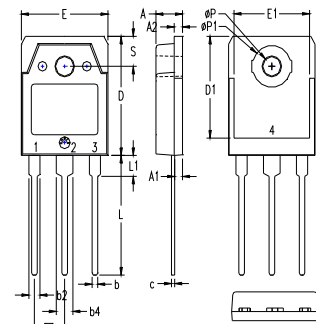

- 1 - GATE
- 2 - DRAIN (COLLECTOR)
- 3 - SOURCE (EMITTER)
- 4 - DRAIN (COLLECTOR)

SYM	INCHES		MILLIMETERS	
	MIN	MAX	MIN	MAX
A	.185	.193	4.70	4.90
A1	.051	.059	1.30	1.50
A2	.057	.065	1.45	1.65
b	.035	.045	0.90	1.15
b2	.075	.087	1.90	2.20
b4	.114	.126	2.90	3.20
c	.022	.031	0.55	0.80
D	.780	.799	19.80	20.30
D1	.665	.677	16.90	17.20
E	.610	.622	15.50	15.80
E1	.531	.539	13.50	13.70
e	.215	BSC	5.45	BSC
L	.779	.795	19.80	20.20
L1	.134	.142	3.40	3.60
ØP	.126	.134	3.20	3.40
ØP1	.272	.280	6.90	7.10
S	.193	.201	4.90	5.10

IXYS Reserves the Right to Change Limits, Test Conditions, and Dimensions.

IXYS MOSFETs and IGBTs are covered by one or more of the following U.S. patents:	4,835,592	4,931,844	5,049,961	5,237,481	6,162,665	6,404,065 B1	6,683,344	6,727,585	7,005,734 B2	7,157,338B2
	4,850,072	5,017,508	5,063,307	5,381,025	6,259,123 B1	6,534,343	6,710,405 B2	6,759,692	7,063,975 B2	
	4,881,106	5,034,796	5,187,117	5,486,715	6,306,728 B1	6,583,505	6,710,463	6,771,478 B2	7,071,537	

Fig. 1. Output Characteristics @ $T_J = 25^\circ\text{C}$

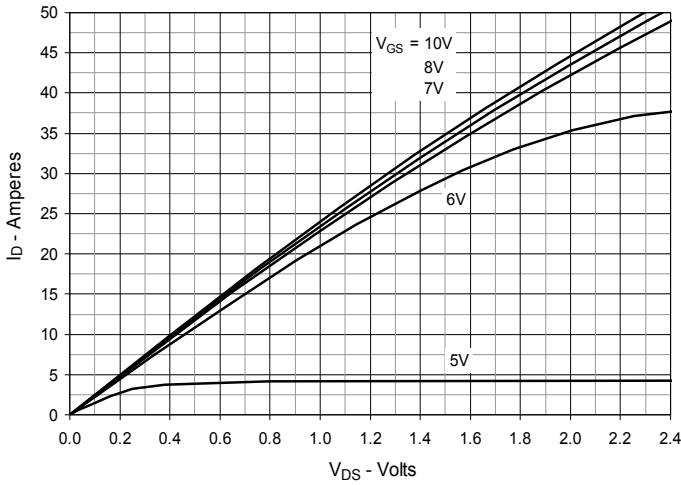

Fig. 2. Extended Output Characteristics @ $T_J = 25^\circ\text{C}$

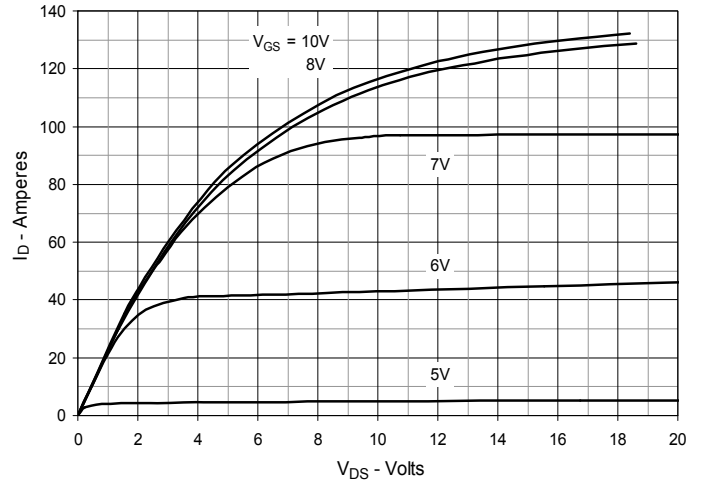

Fig. 3. Output Characteristics @ $T_J = 150^\circ\text{C}$

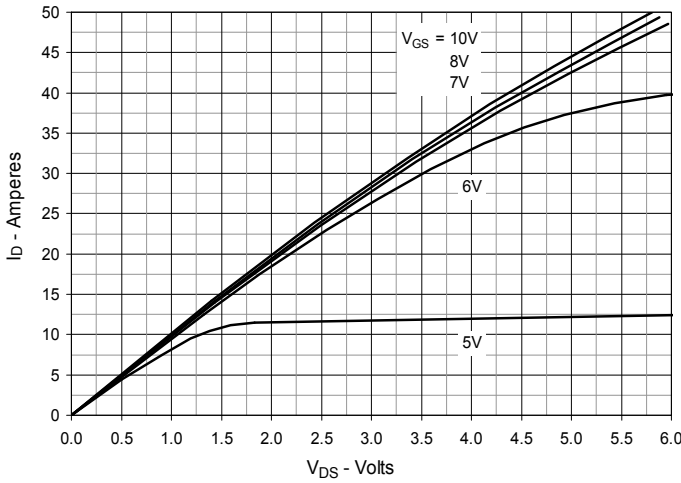

Fig. 4. $R_{DS(on)}$ Normalized to $I_D = 24\text{A}$ Value vs. Junction Temperature

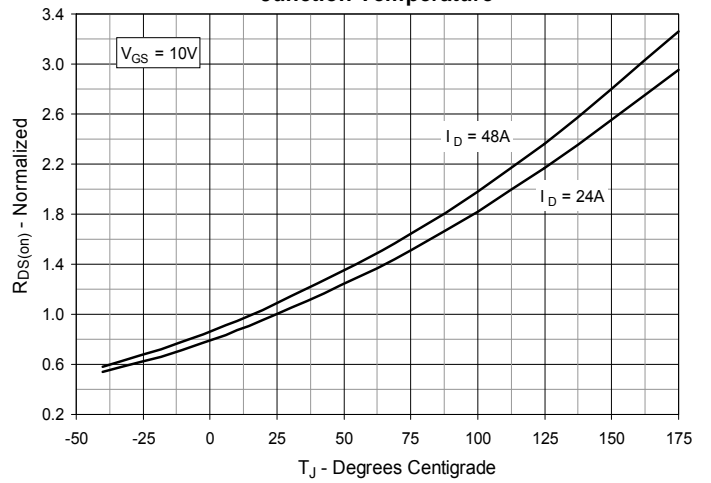

Fig. 5. $R_{DS(on)}$ Normalized to $I_D = 24\text{A}$ Value vs. Drain Current

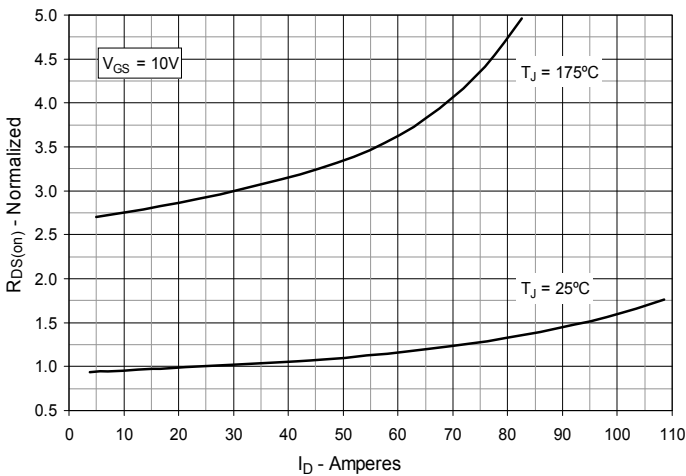

Fig. 6. Maximum Drain Current vs. Case Temperature

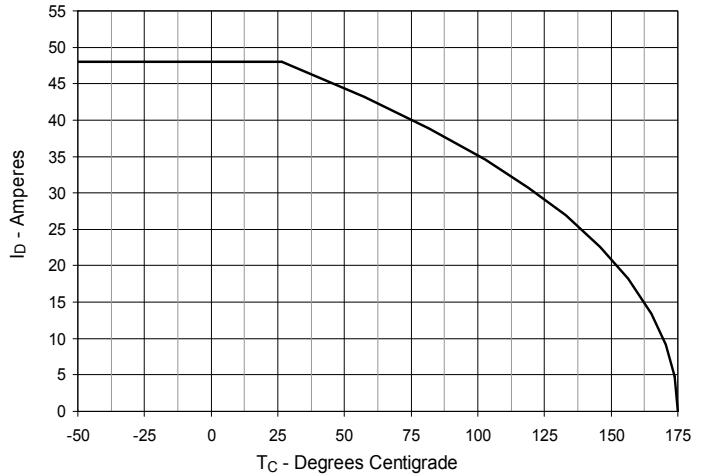

Fig. 7. Input Admittance

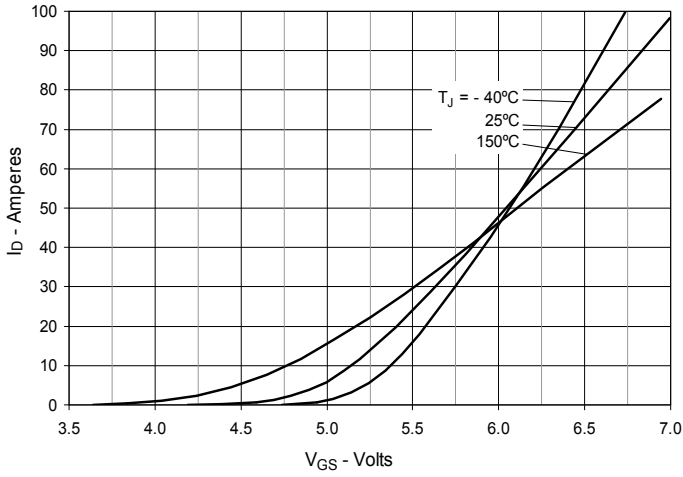

Fig. 8. Transconductance

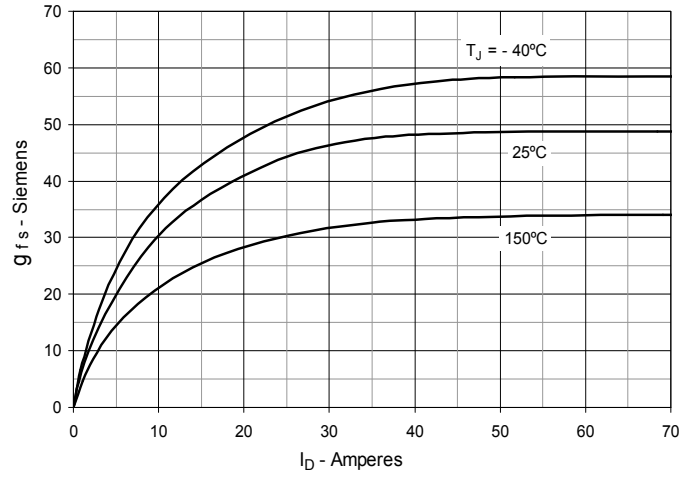

Fig. 9. Forward Voltage Drop of Intrinsic Diode

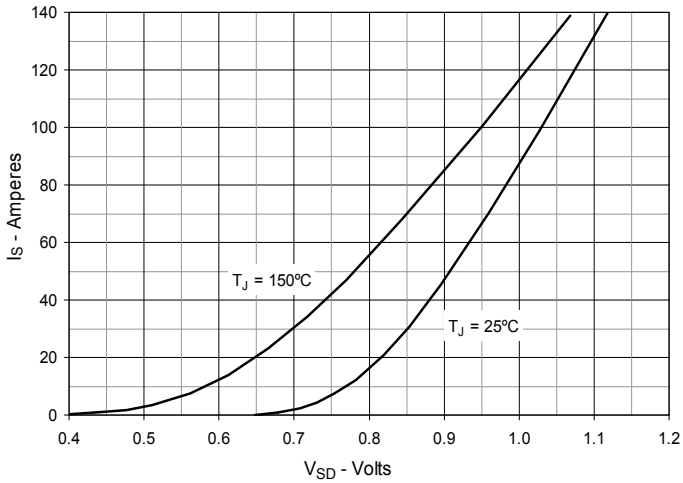

Fig. 10. Gate Charge

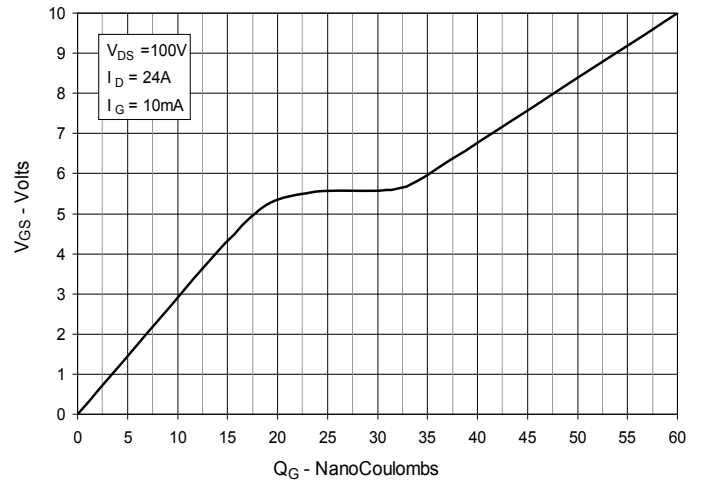

Fig. 11. Capacitance

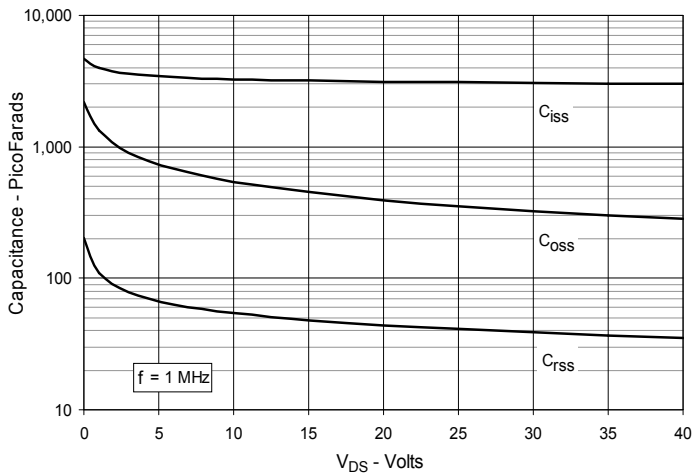

Fig. 12. Maximum Transient Thermal Impedance

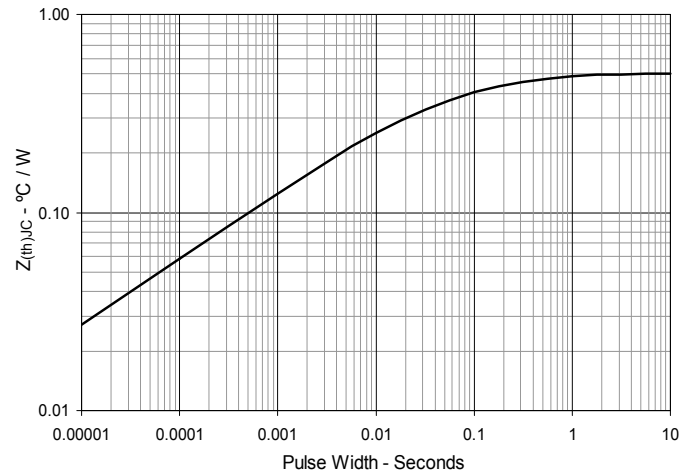

Fig. 13. Resistive Turn-on Rise Time vs. Junction Temperature

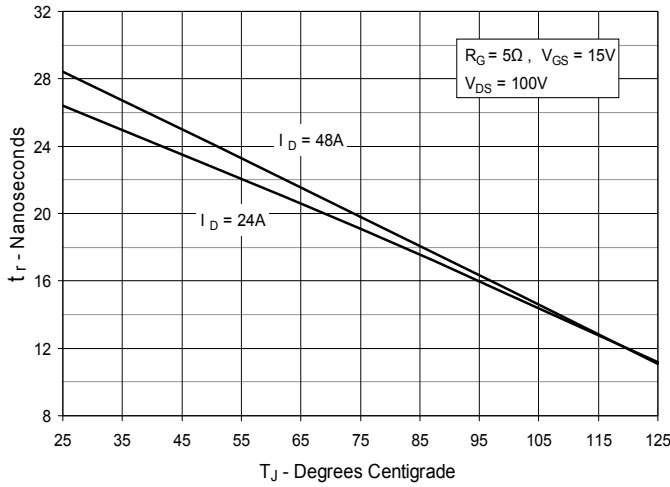

Fig. 14. Resistive Turn-on Rise Time vs. Drain Current

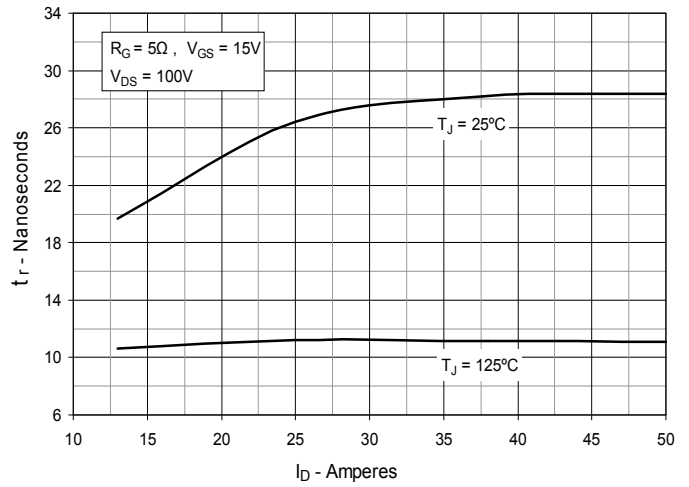

Fig. 15. Resistive Turn-on Switching Times vs. Gate Resistance

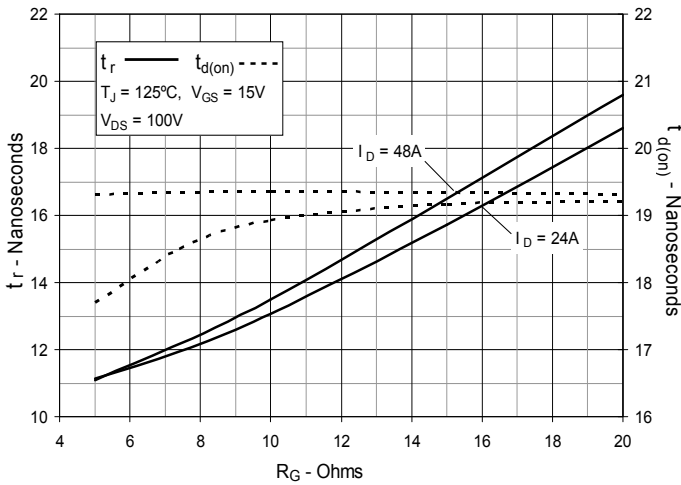

Fig. 16. Resistive Turn-off Switching Times vs. Junction Temperature

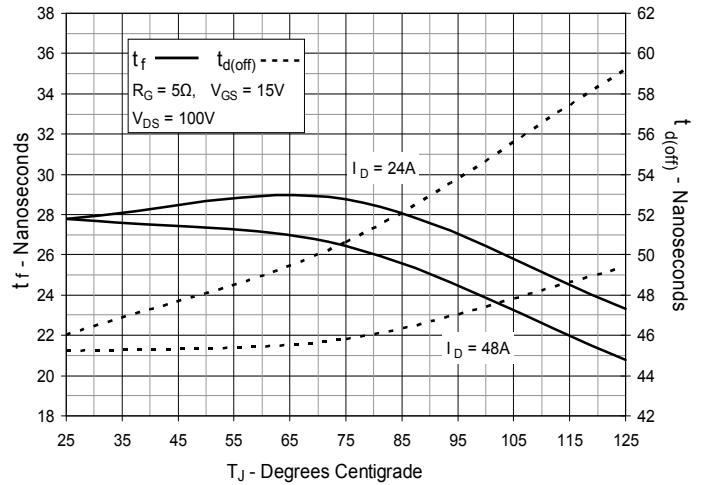

Fig. 17. Resistive Turn-off Switching Times vs. Drain Current

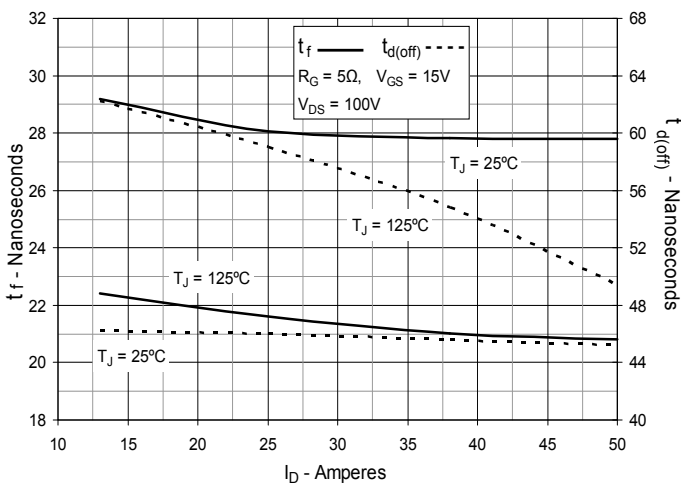
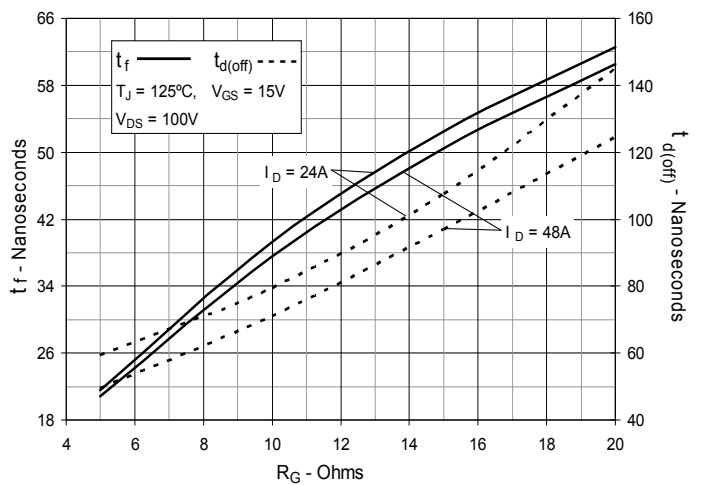

Fig. 18. Resistive Turn-off Switching Times vs. Gate Resistance





Disclaimer Notice - Information furnished is believed to be accurate and reliable. However, users should independently evaluate the suitability of and test each product selected for their own applications. Littelfuse products are not designed for, and may not be used in, all applications. Read complete Disclaimer Notice at www.littelfuse.com/disclaimer-electronics.