

**TrenchT2™ HiperFET™**  
**Power MOSFET**
**IXFH400N075T2**  
**IXFT400N075T2**

$$V_{DSS} = 75V$$

$$I_{D25} = 400A$$

$$R_{DS(on)} \leq 2.3m\Omega$$

N-Channel Enhancement Mode  
 Avalanche Rated  
 Fast Intrinsic Diode



| Symbol     | Test Conditions  | Maximum Ratings |            |
|------------|--|-----------------|------------|
| $V_{DSS}$  | $T_J = 25^\circ C$ to $175^\circ C$                                | 75              | V          |
| $V_{DGR}$  | $T_J = 25^\circ C$ to $175^\circ C$ , $R_{GS} = 1M\Omega$          | 75              | V          |
| $V_{GSS}$  | Continuous   | $\pm 20$        | V          |
| $V_{GSM}$  | Transient  | $\pm 30$        | V          |
| $I_{D25}$  | $T_C = 25^\circ C$ (Chip Capability)                               | 400             | A          |
| $I_{LRMS}$ | Lead Current Limit, RMS  | 160             | A          |
| $I_{DM}$   | $T_C = 25^\circ C$ , Pulse Width Limited by $T_{JM}$               | 1000            | A          |
| $I_A$      | $T_C = 25^\circ C$   | 200             | A          |
| $E_{AS}$   | $T_C = 25^\circ C$   | 1.5             | J          |
| $dv/dt$    | $I_S \leq I_{DM}$ , $V_{DD} \leq V_{DSS}$ , $T_J \leq 175^\circ C$ | 15              | V/ns       |
| $P_D$      | $T_C = 25^\circ C$   | 1000            | W          |
| $T_J$      |  | -55 ... +175    | $^\circ C$ |
| $T_{JM}$   |  | 175             | $^\circ C$ |
| $T_{stg}$  |  | -55 ... +175    | $^\circ C$ |
| $T_L$      | 1.6mm (0.062in.) from Case for 10s                                 | 300             | $^\circ C$ |
| $T_{sold}$ | Plastic Body for 10 seconds  | 260             | $^\circ C$ |
| $M_d$      | Mounting Torque (TO-247)   | 1.13 / 10       | Nm/lb.in.  |
| Weight     | TO-247   | 6               | g          |
|            | TO-268   | 4               | g          |

| Symbol       | Test Conditions   | Characteristic Values |      |                |
|--------------|---|-----------------------|------|----------------|
|              |   | Min.                  | Typ. | Max.           |
| $BV_{DSS}$   | $V_{GS} = 0V$ , $I_D = 1mA$                               | 75                    |      | V              |
| $V_{GS(th)}$ | $V_{DS} = V_{GS}$ , $I_D = 250\mu A$                      | 2.0                   |      | 4.0 V          |
| $I_{GSS}$    | $V_{GS} = \pm 20V$ , $V_{DS} = 0V$                        |                       |      | $\pm 200$ nA   |
| $I_{DSS}$    | $V_{DS} = V_{DSS}$ , $V_{GS} = 0V$<br>$T_J = 150^\circ C$ |                       |      | 25 $\mu A$     |
|              |   |                       |      | 1.5 mA         |
| $R_{DS(on)}$ | $V_{GS} = 10V$ , $I_D = 100A$ , Notes 1 & 2               |                       |      | 2.3 m $\Omega$ |

TO-247 (IXFH)

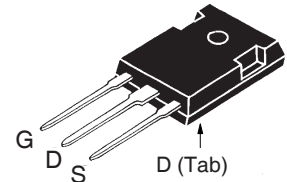

TO-268 (IXFT)

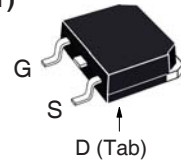

G = Gate      D = Drain  
 S = Source    Tab = Drain

**Features**

- International Standard Packages
- 175°C Operating Temperature
- High Current Handling Capability
- Avalanche Rated
- Fast Intrinsic Diode
- Low  $R_{DS(on)}$

**Advantages**

- Easy to Mount
- Space Savings
- High Power Density

**Applications**

- DC/DC Converters and Off-line UPS
- Primary- Side Switch
- High Current Switching Applications

| Symbol       | Test Conditions<br>( $T_J = 25^\circ\text{C}$ , Unless Otherwise Specified)  | Characteristic Values |      |                        |
|--------------|--|-----------------------|------|------------------------|
|              |  | Min.                  | Typ. | Max.                   |
| $g_{fs}$     | $V_{DS} = 10\text{V}$ , $I_D = 60\text{A}$ , Note 1  | 80                    | 130  | S                      |
| $C_{iss}$    | $V_{GS} = 0\text{V}$ , $V_{DS} = 25\text{V}$ , $f = 1\text{MHz}$   |                       | 24   | nF                     |
| $C_{oss}$    |  |                       | 2770 | pF                     |
| $C_{rss}$    |  |                       | 455  | pF                     |
| $R_{Gi}$     | Gate Input Resistance  |                       | 1.33 | $\Omega$               |
| $t_{d(on)}$  | <b>Resistive Switching Times</b><br>$V_{GS} = 10\text{V}$ , $V_{DS} = 0.5 \cdot V_{DSS}$ , $I_D = 200\text{A}$<br>$R_G = 1\Omega$ (External) |                       | 35   | ns                     |
| $t_r$        |  |                       | 20   | ns                     |
| $t_{d(off)}$ |  |                       | 67   | ns                     |
| $t_f$        |  |                       | 44   | ns                     |
| $Q_{g(on)}$  | $V_{GS} = 10\text{V}$ , $V_{DS} = 0.5 \cdot V_{DSS}$ , $I_D = 0.5 \cdot I_{D25}$   |                       | 420  | nC                     |
| $Q_{gs}$     |  |                       | 114  | nC                     |
| $Q_{gd}$     |  |                       | 130  | nC                     |
| $R_{thJC}$   |  |                       |      | $0.15^\circ\text{C/W}$ |
| $R_{thCH}$   | TO-247   | 0.21                  |      | $^\circ\text{C/W}$     |

### Source-Drain Diode

| Symbol   | Test Conditions<br>( $T_J = 25^\circ\text{C}$ , Unless Otherwise Specified)                              | Characteristic Values |      |        |
|----------|--|-----------------------|------|--------|
|          |  | Min.                  | Typ. | Max.   |
| $I_S$    | $V_{GS} = 0\text{V}$   |                       |      | 400 A  |
| $I_{SM}$ | Repetitive, Pulse Width Limited by $T_{JM}$  |                       |      | 1200 A |
| $V_{SD}$ | $I_F = 100\text{A}$ , $V_{GS} = 0\text{V}$ , Note 1  |                       |      | 1.2 V  |
| $t_{rr}$ | $I_F = 100\text{A}$ , $V_{GS} = 0\text{V}$<br>$-di/dt = 100\text{A}/\mu\text{s}$<br>$V_R = 37.5\text{V}$ |                       | 77   | ns     |
| $I_{RM}$ |  |                       | 5.4  | A      |
| $Q_{RM}$ |  |                       | 210  | nC     |

### Notes:

1. Pulse test,  $t \leq 300\mu\text{s}$ , duty cycle,  $d \leq 2\%$ .
2. Includes lead resistance.

### ADVANCE TECHNICAL INFORMATION

The product presented herein is under development. The Technical Specifications offered are derived from a subjective evaluation of the design, based upon prior knowledge and experience, and constitute a "considered reflection" of the anticipated result. IXYS reserves the right to change limits, test conditions, and dimensions without notice.

### IXYS Reserves the Right to Change Limits, Test Conditions, and Dimensions.

IXYS MOSFETs and IGBTs are covered 4,835,592 4,931,844 5,049,961 5,237,481 6,162,665 6,404,065 B1 6,683,344 6,727,585 7,005,734 B2 7,157,338B2  
by one or more of the following U.S. patents: 4,850,072 5,017,508 5,063,307 5,381,025 6,259,123 B1 6,534,343 6,710,405 B2 6,759,692 7,063,975 B2  
4,881,106 5,034,796 5,187,117 5,486,715 6,306,728 B1 6,583,505 6,710,463 6,771,478 B2 7,071,537

### TO-247 (IXFH) Outline

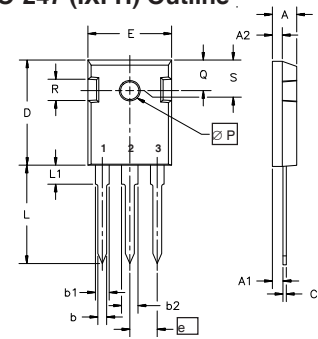

Terminals: 1 - Gate 2 - Drain  
3 - Source Tab - Drain

| Dim.           | Millimeter |       | Inches |       |
|----------------|------------|-------|--------|-------|
|                | Min.       | Max.  | Min.   | Max.  |
| A              | 4.7        | 5.3   | .185   | .209  |
| A <sub>1</sub> | 2.2        | 2.54  | .087   | .102  |
| A <sub>2</sub> | 2.2        | 2.6   | .059   | .098  |
| b              | 1.0        | 1.4   | .040   | .055  |
| b <sub>1</sub> | 1.65       | 2.13  | .065   | .084  |
| b <sub>2</sub> | 2.87       | 3.12  | .113   | .123  |
| C              | .4         | .8    | .016   | .031  |
| D              | 20.80      | 21.46 | .819   | .845  |
| E              | 15.75      | 16.26 | .610   | .640  |
| e              | 5.20       | 5.72  | 0.205  | 0.225 |
| L              | 19.81      | 20.32 | .780   | .800  |
| L1             |            | 4.50  |        | .177  |
| ∅P             | 3.55       | 3.65  | .140   | .144  |
| Q              | 5.89       | 6.40  | 0.232  | 0.252 |
| R              | 4.32       | 5.49  | .170   | .216  |
| S              | 6.15       | BSC   | 242    | BSC   |

### TO-268 (IXFT) Outline

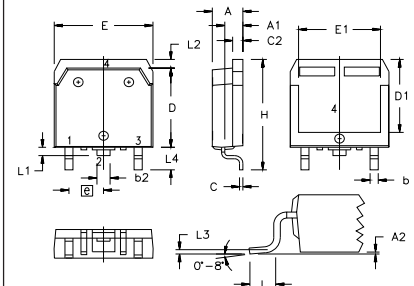

Terminals: 1 - Gate 2 - Drain  
3 - Source Tab - Drain

| SYM | INCHES   |      | MILLIMETERS |       |
|-----|----------|------|-------------|-------|
|     | MIN      | MAX  | MIN         | MAX   |
| A   | .193     | .201 | 4.90        | 5.10  |
| A1  | .106     | .114 | 2.70        | 2.90  |
| A2  | .001     | .010 | 0.02        | 0.25  |
| b   | .045     | .057 | 1.15        | 1.45  |
| b2  | .075     | .083 | 1.90        | 2.10  |
| C   | .016     | .026 | 0.40        | 0.65  |
| C2  | .057     | .063 | 1.45        | 1.60  |
| D   | .543     | .551 | 13.80       | 14.00 |
| D1  | .488     | .500 | 12.40       | 12.70 |
| E   | .624     | .632 | 15.85       | 16.05 |
| E1  | .524     | .535 | 13.30       | 13.60 |
| e   | .215 BSC |      | 5.45 BSC    |       |
| H   | .736     | .752 | 18.70       | 19.10 |
| L   | .094     | .106 | 2.40        | 2.70  |
| L1  | .047     | .055 | 1.20        | 1.40  |
| L2  | .039     | .045 | 1.00        | 1.15  |
| L3  | .010 BSC |      | 0.25 BSC    |       |
| L4  | .150     | .161 | 3.80        | 4.10  |

Fig. 1. Output Characteristics @  $T_J = 25^\circ\text{C}$

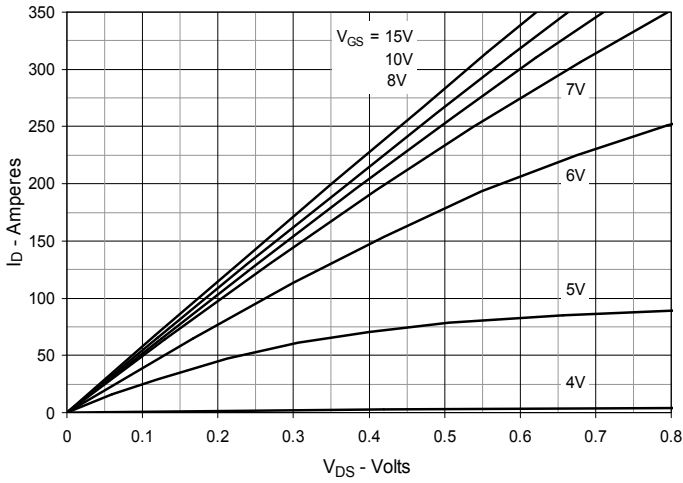

Fig. 2. Extended Output Characteristics @  $T_J = 25^\circ\text{C}$

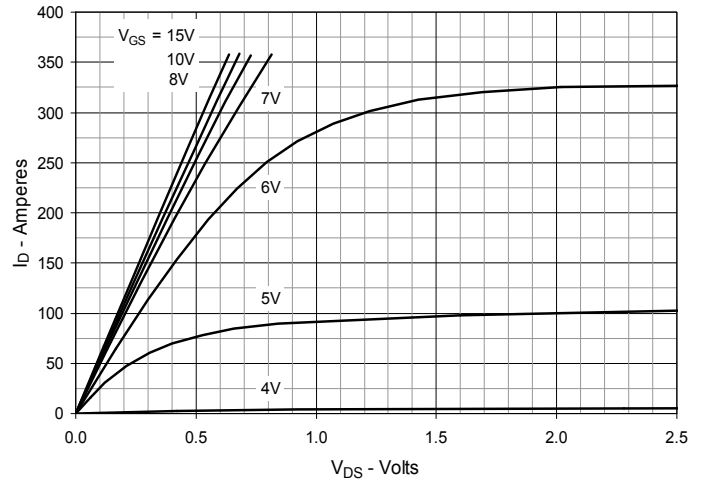

Fig. 3. Output Characteristics @  $T_J = 150^\circ\text{C}$

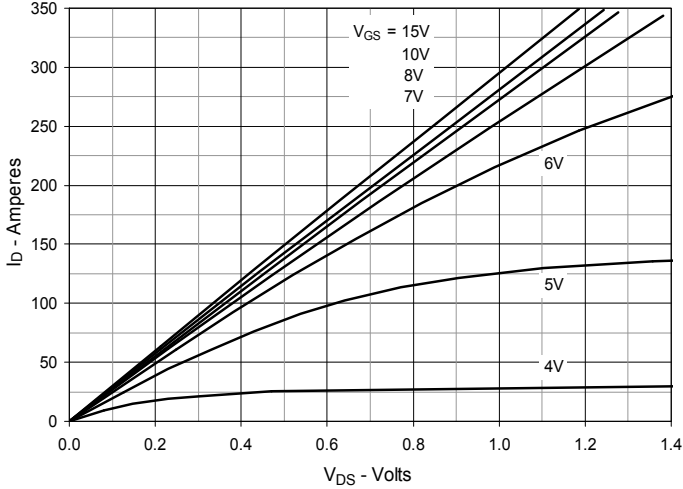

Fig. 4.  $R_{DS(on)}$  Normalized to  $I_D = 200\text{A}$  Value vs. Junction Temperature

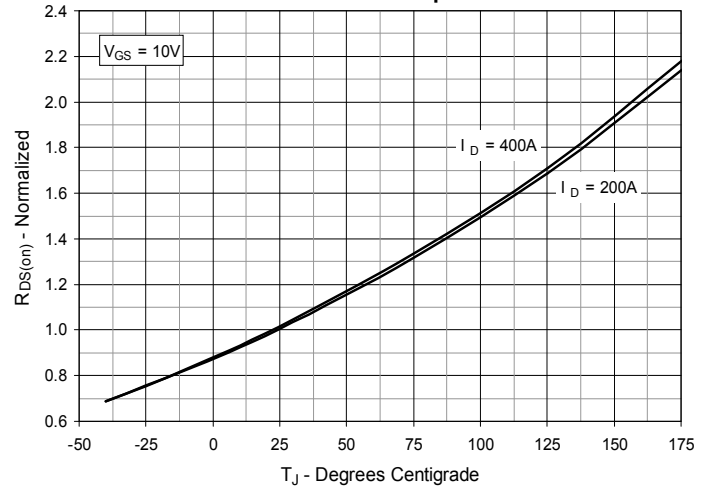

Fig. 5.  $R_{DS(on)}$  Normalized to  $I_D = 200\text{A}$  vs. Drain Current

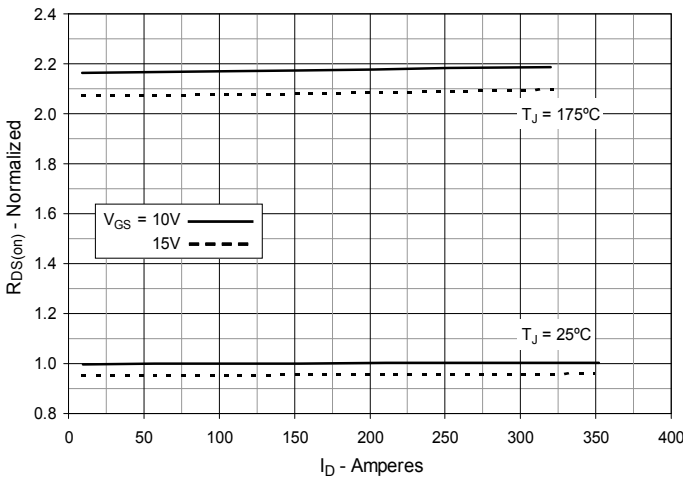
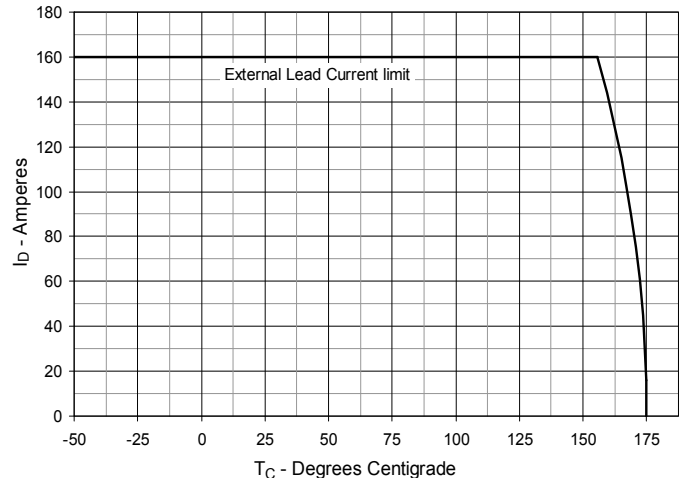
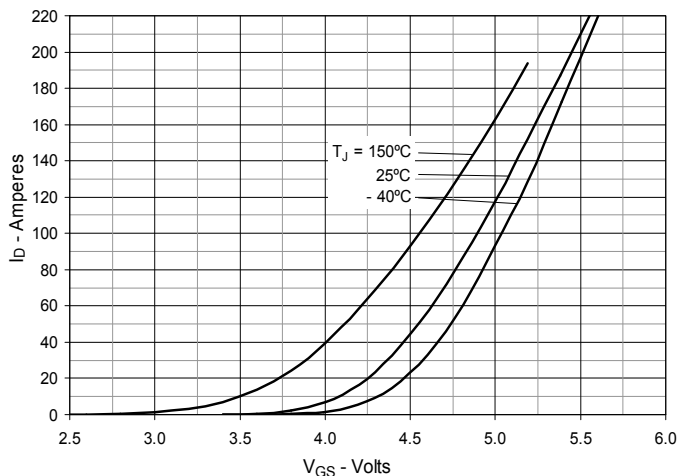

Fig. 6. Drain Current vs. Case Temperature



**Fig. 7. Input Admittance**



**Fig. 8. Transconductance**

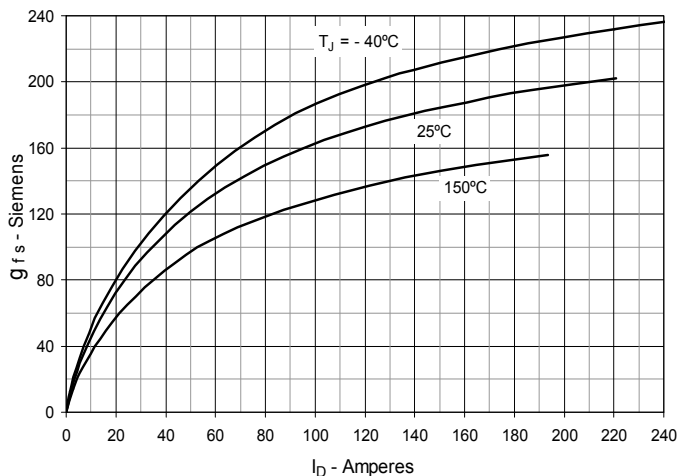

**Fig. 9. Forward Voltage Drop of Intrinsic Diode**

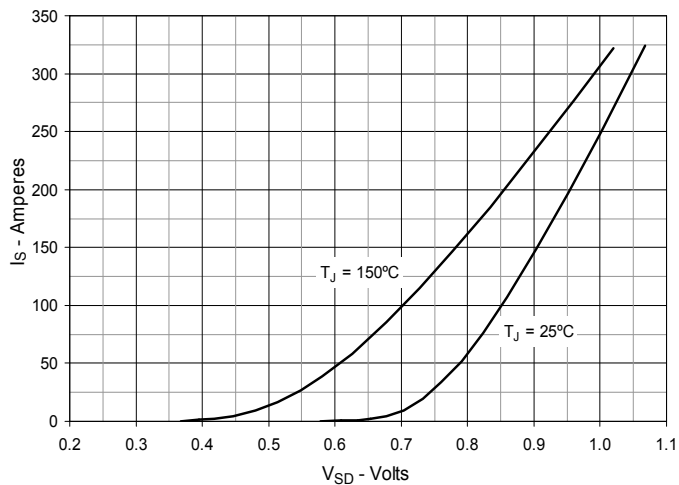

**Fig. 10. Gate Charge**

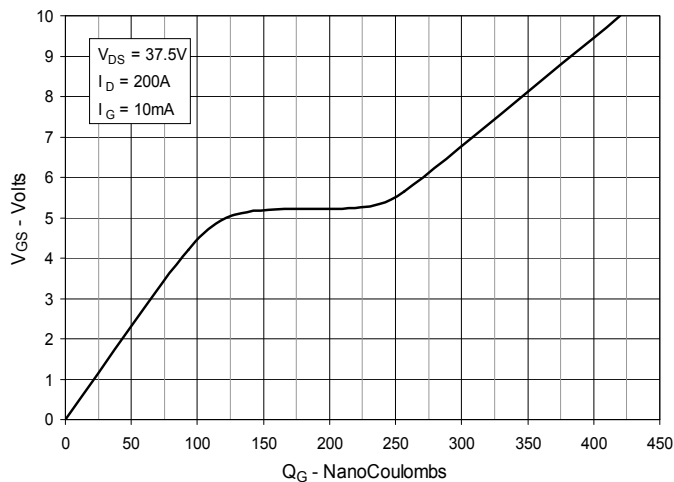

**Fig. 11. Capacitance**

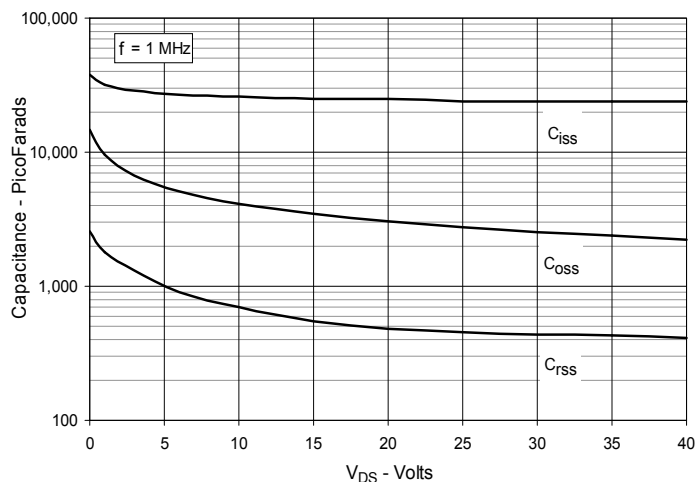

**Fig. 12. Forward-Bias Safe Operating Area**

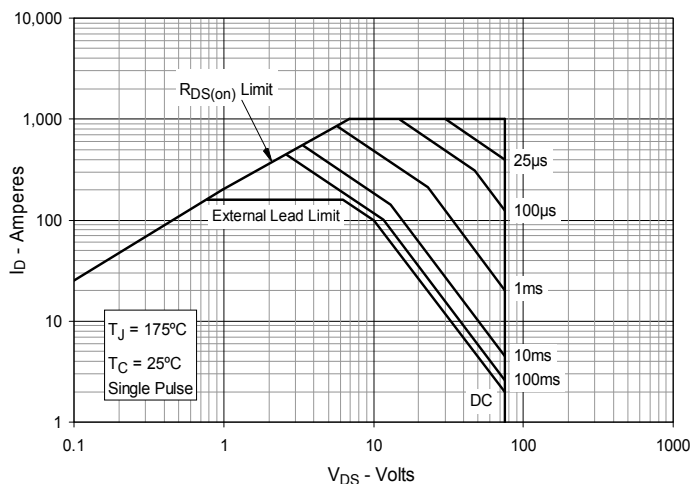

**Fig. 13. Resistive Turn-on Rise Time vs. Junction Temperature**

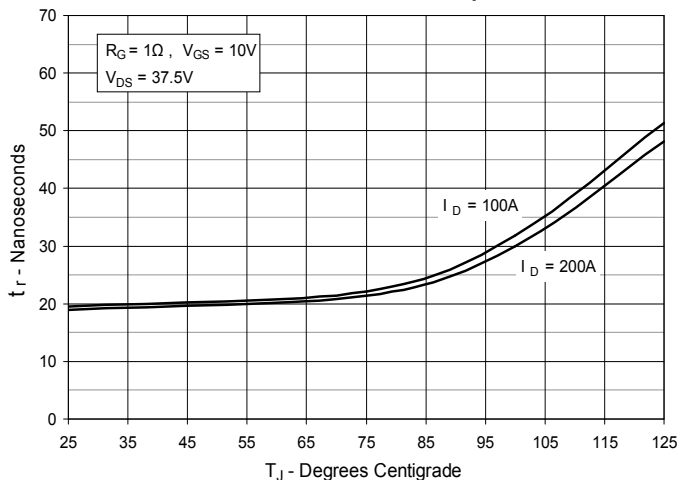

**Fig. 14. Resistive Turn-on Rise Time vs. Drain Current**

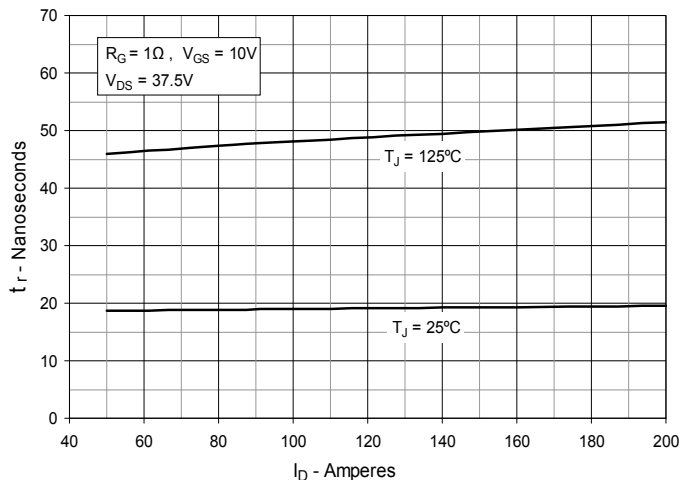

**Fig. 15. Resistive Turn-on Switching Times vs. Gate Resistance**

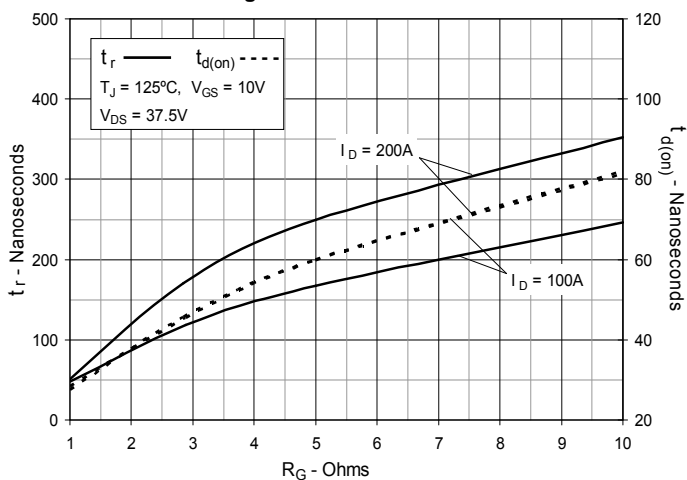

**Fig. 16. Resistive Turn-off Switching Times vs. Junction Temperature**

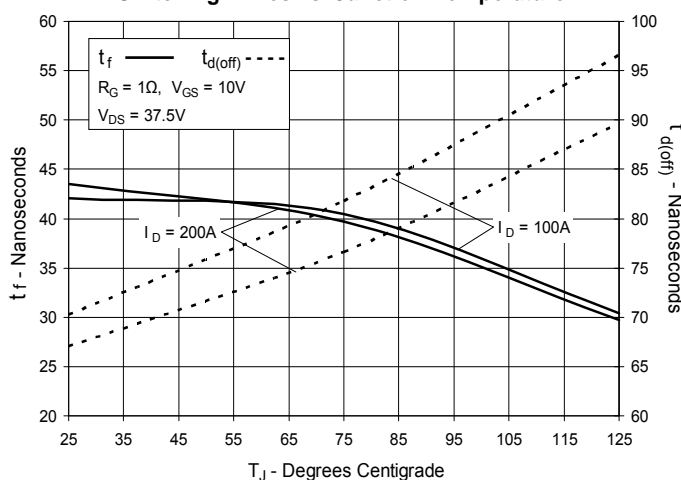

**Fig. 17. Resistive Turn-off Switching Times vs. Drain Current**

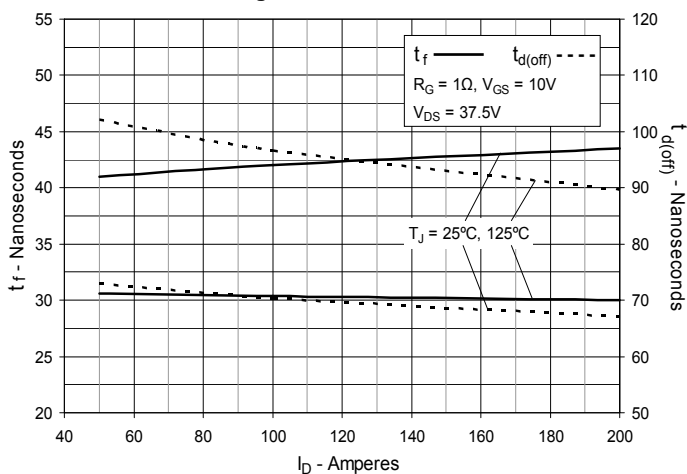

**Fig. 18. Resistive Turn-off Switching Times vs. Gate Resistance**

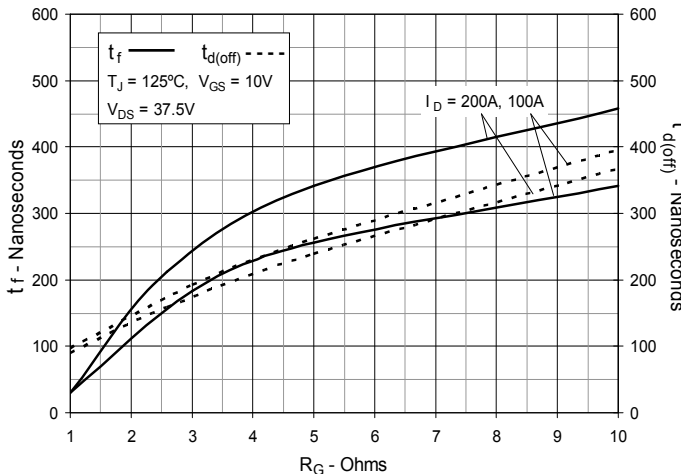
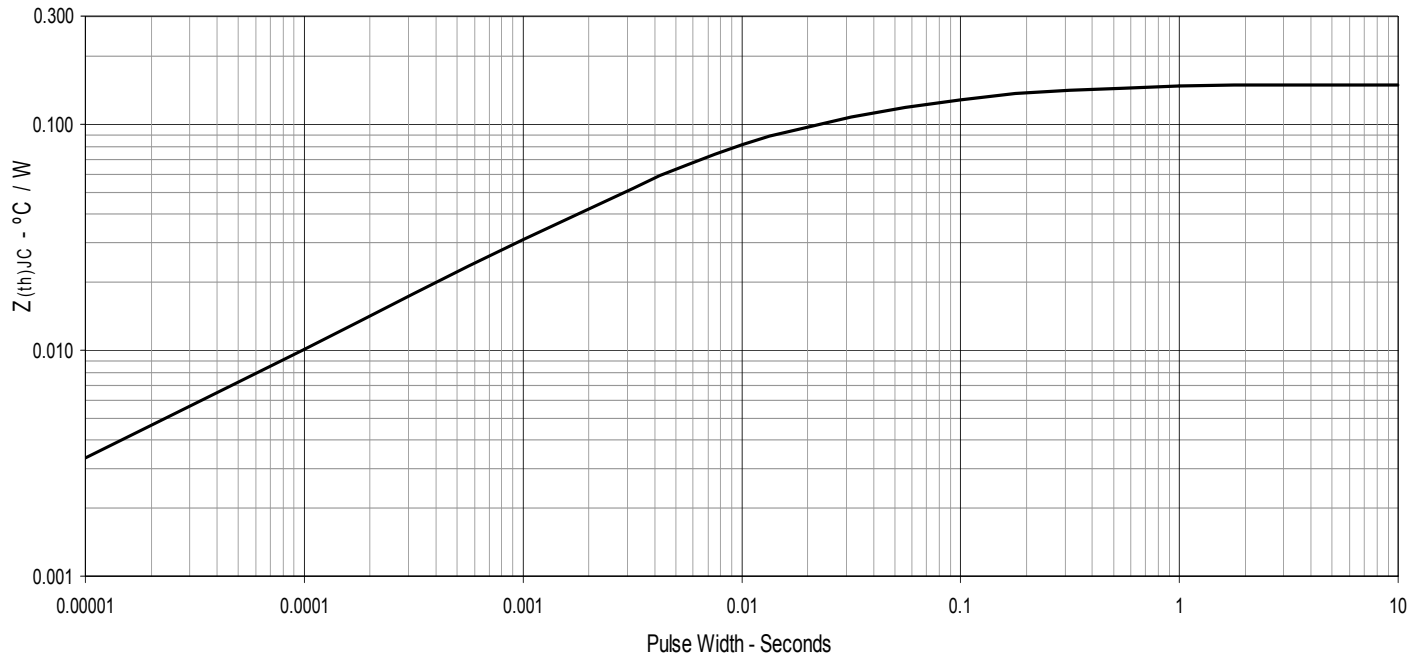

Fig. 19. Maximum Transient Thermal Impedance





---

Disclaimer Notice - Information furnished is believed to be accurate and reliable. However, users should independently evaluate the suitability of and test each product selected for their own applications. Littelfuse products are not designed for, and may not be used in, all applications. Read complete Disclaimer Notice at [www.littelfuse.com/disclaimer-electronics](http://www.littelfuse.com/disclaimer-electronics).