

High Voltage Power MOSFET

IXTT12N150 IXTH12N150

$V_{DSS} = 1500V$
 $I_{D25} = 12A$
 $R_{DS(on)} \leq 2.2\Omega$

N-Channel Enhancement Mode
 Avalanche Rated
 Fast Intrinsic Diode

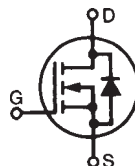

| Symbol | Test Conditions | Maximum Ratings | |
|------------|--|-----------------|------------|
| V_{DSS} | $T_J = 25^\circ C$ to $150^\circ C$ | 1500 | V |
| V_{DGR} | $T_J = 25^\circ C$ to $150^\circ C$, $R_{GS} = 1M\Omega$ | 1500 | V |
| V_{GSS} | Continuous | ± 30 | V |
| V_{GSM} | Transient | ± 40 | V |
| I_{D25} | $T_C = 25^\circ C$ | 12 | A |
| I_{DM} | $T_C = 25^\circ C$, Pulse Width Limited by T_{JM} | 40 | A |
| I_A | $T_C = 25^\circ C$ | 6 | A |
| E_{AS} | $T_C = 25^\circ C$ | 750 | mJ |
| dv/dt | $I_S \leq I_{DM}$, $V_{DD} \leq V_{DSS}$, $T_J \leq 150^\circ C$ | 5 | V/ns |
| P_D | $T_C = 25^\circ C$ | 890 | W |
| T_J | | - 55 ... +150 | $^\circ C$ |
| T_{JM} | | 150 | $^\circ C$ |
| T_{stg} | | - 55 ... +150 | $^\circ C$ |
| T_L | 1.6mm (0.062 in.) From Case for 10s | 300 | $^\circ C$ |
| T_{SOLD} | Plastic Body for 10s | 260 | $^\circ C$ |
| M_d | Mounting Torque | 1.13 / 10 | Nm/lb.in. |
| Weight | TO-268 | 4.0 | g |
| | TO-247 | 6.0 | g |

TO-268 (IXTT)

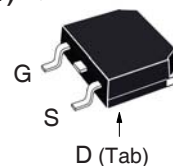

TO-247 (IXTH)

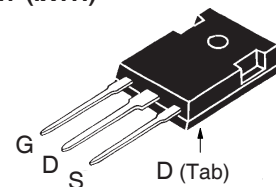

G = Gate D = Drain
 S = Source Tab = Drain

Features

- International Standard Packages
- Molding Epoxies Meet UL 94 V-0 Flammability Classification
- Fast Intrinsic Diode
- Low Package Inductance

Advantages

- Easy to Mount
- Space Savings
- High Power Density

Applications

- High Voltage Power Supplies
- Capacitor Discharge
- Pulse Circuits

| Symbol | Test Conditions ($T_J = 25^\circ C$, Unless Otherwise Specified) | Characteristic Values | | |
|--------------|---|-----------------------|------|---------------------------|
| | | Min. | Typ. | Max. |
| BV_{DSS} | $V_{GS} = 0V$, $I_D = 1mA$ | 1500 | | V |
| $V_{GS(th)}$ | $V_{DS} = V_{GS}$, $I_D = 250\mu A$ | 2.5 | | 4.5 V |
| I_{GSS} | $V_{GS} = \pm 30V$, $V_{DS} = 0V$ | | | ± 100 nA |
| I_{DSS} | $V_{DS} = V_{DSS}$, $V_{GS} = 0V$ $T_J = 125^\circ C$ | | | 25 μA 500 μA |
| $R_{DS(on)}$ | $V_{GS} = 10V$, $I_D = 0.5 \cdot I_{D25}$, Note 1 | | | 2.2 Ω |

| Symbol | Test Conditions ($T_J = 25^\circ\text{C}$, Unless Otherwise Specified) | Characteristic Values | | |
|--------------|--|-----------------------|------|-------------------------|
| | | Min. | Typ. | Max. |
| g_{fs} | $V_{DS} = 20\text{V}$, $I_D = 0.5 \cdot I_{D25}$, Note 1 | 8 | 13 | S |
| C_{iss} | $V_{GS} = 0\text{V}$, $V_{DS} = 25\text{V}$, $f = 1\text{MHz}$ | | 3720 | pF |
| C_{oss} | | | 240 | pF |
| C_{rss} | | | 80 | pF |
| $t_{d(on)}$ | Resistive Switching Times $V_{GS} = 10\text{V}$, $V_{DS} = 0.5 \cdot V_{DSS}$, $I_D = 0.5 \cdot I_{D25}$ $R_G = 2\Omega$ (External) | | 26 | ns |
| t_r | | | 16 | ns |
| $t_{d(off)}$ | | | 53 | ns |
| t_f | | | 14 | ns |
| $Q_{g(on)}$ | $V_{GS} = 10\text{V}$, $V_{DS} = 0.5 \cdot V_{DSS}$, $I_D = 0.5 \cdot I_{D25}$ | | 106 | nC |
| Q_{gs} | | | 17 | nC |
| Q_{gd} | | | 50 | nC |
| R_{thJC} | | | | 0.14 $^\circ\text{C/W}$ |
| R_{thCS} | TO-247 | 0.21 | | $^\circ\text{C/W}$ |

Source-Drain Diode

| Symbol | Test Conditions ($T_J = 25^\circ\text{C}$, Unless Otherwise Specified) | Characteristic Values | | |
|----------|--|-----------------------|------|---------------|
| | | Min. | Typ. | Max. |
| I_S | $V_{GS} = 0\text{V}$ | | | 12 A |
| I_{SM} | Repetitive, Pulse Width Limited by T_{JM} | | | 48 A |
| V_{SD} | $I_F = I_S$, $V_{GS} = 0\text{V}$, Note 1 | | | 1.4 V |
| t_{rr} | $I_F = 6\text{A}$, $-di/dt = 100\text{A}/\mu\text{s}$ $V_R = 100\text{V}$, $V_{GS} = 0\text{V}$ | | 1.2 | μs |
| I_{RM} | | | 24.5 | A |
| Q_{RM} | | | 14.8 | μC |

Note 1. Pulse test, $t \leq 300\mu\text{s}$, duty cycle, $d \leq 2\%$.

TO-268 Outline

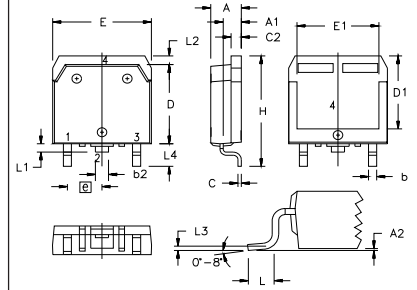

Terminals: 1 - Gate, 2,4 - Drain, 3 - Source

| SYM | INCHES | | MILLIMETERS | |
|-----|----------|------|-------------|-------|
| | MIN | MAX | MIN | MAX |
| A | .193 | .201 | 4.90 | 5.10 |
| A1 | .106 | .114 | 2.70 | 2.90 |
| A2 | .001 | .010 | 0.02 | 0.25 |
| b | .045 | .057 | 1.15 | 1.45 |
| b2 | .075 | .083 | 1.90 | 2.10 |
| C | .016 | .026 | 0.40 | 0.65 |
| C2 | .057 | .063 | 1.45 | 1.60 |
| D | .543 | .551 | 13.80 | 14.00 |
| D1 | .488 | .500 | 12.40 | 12.70 |
| E | .624 | .632 | 15.85 | 16.05 |
| E1 | .524 | .535 | 13.30 | 13.60 |
| e | .215 BSC | | 5.45 BSC | |
| H | .736 | .752 | 18.70 | 19.10 |
| L | .094 | .106 | 2.40 | 2.70 |
| L1 | .047 | .055 | 1.20 | 1.40 |
| L2 | .039 | .045 | 1.00 | 1.15 |
| L3 | .010 BSC | | 0.25 BSC | |
| L4 | .150 | .161 | 3.80 | 4.10 |

TO-247 Outline

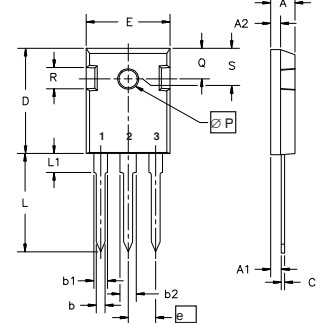

Terminals: 1 - Gate, 2 - Drain, 3 - Source

| Dim. | Millimeter | | Inches | |
|----------------|------------|----------|--------|---------|
| | Min. | Max. | Min. | Max. |
| A | 4.7 | 5.3 | .185 | .209 |
| A ₁ | 2.2 | 2.54 | .087 | .102 |
| A ₂ | 2.2 | 2.6 | .059 | .098 |
| b | 1.0 | 1.4 | .040 | .055 |
| b ₁ | 1.65 | 2.13 | .065 | .084 |
| b ₂ | 2.87 | 3.12 | .113 | .123 |
| C | .4 | .8 | .016 | .031 |
| D | 20.80 | 21.46 | .819 | .845 |
| E | 15.75 | 16.26 | .610 | .640 |
| e | 5.20 | 5.72 | 0.205 | 0.225 |
| L | 19.81 | 20.32 | .780 | .800 |
| L1 | | 4.50 | | .177 |
| ∅P | 3.55 | 3.65 | .140 | .144 |
| Q | 5.89 | 6.40 | 0.232 | 0.252 |
| R | 4.32 | 5.49 | .170 | .216 |
| S | | 6.15 BSC | | 242 BSC |

IXYS Reserves the Right to Change Limits, Test Conditions, and Dimensions.

IXYS MOSFETs and IGBTs are covered by one or more of the following U.S. patents:

| | | | | | | | | | |
|-----------|-----------|-----------|-----------|--------------|--------------|--------------|--------------|--------------|-------------|
| 4,835,592 | 4,931,844 | 5,049,961 | 5,237,481 | 6,162,665 | 6,404,065 B1 | 6,683,344 | 6,727,585 | 7,005,734 B2 | 7,157,338B2 |
| 4,860,072 | 5,017,508 | 5,063,307 | 5,381,025 | 6,259,123 B1 | 6,534,343 | 6,710,405 B2 | 6,759,692 | 7,063,975 B2 | |
| 4,881,106 | 5,034,796 | 5,187,117 | 5,486,715 | 6,306,728 B1 | 6,583,505 | 6,710,463 | 6,771,478 B2 | 7,071,537 | |

Fig. 1. Output Characteristics @ $T_J = 25^\circ\text{C}$

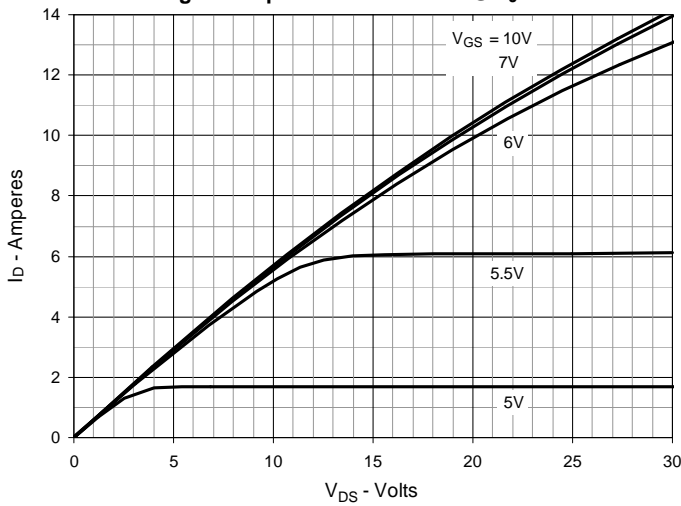

Fig. 2. Output Characteristics @ $T_J = 125^\circ\text{C}$

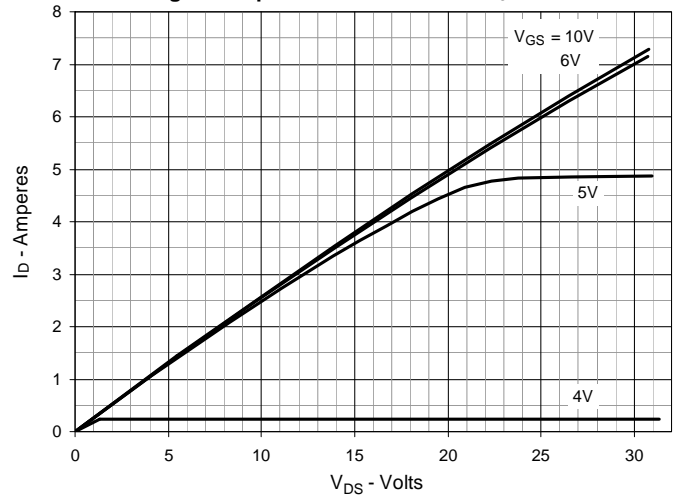

Fig. 3. $R_{DS(on)}$ Normalized to $I_D = 6\text{A}$ Value vs. Junction Temperature

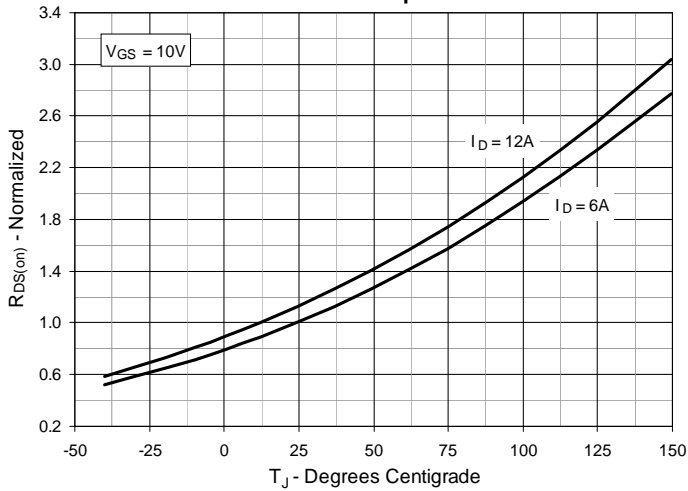

Fig. 4. $R_{DS(on)}$ Normalized to $I_D = 6\text{A}$ Value vs. Drain Current

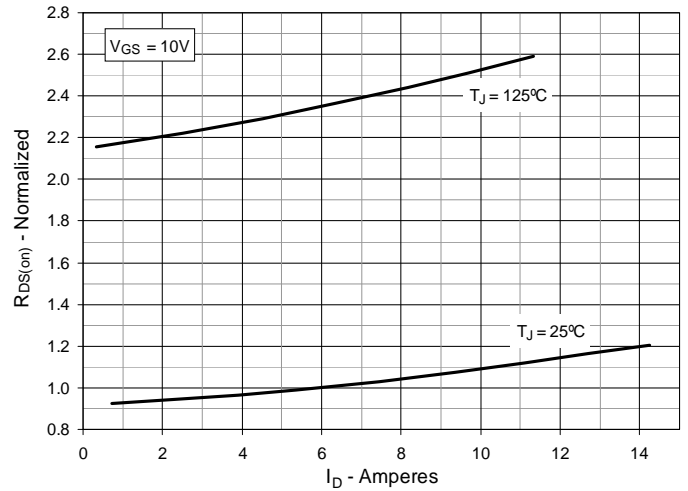

Fig. 5. Maximum Drain Current vs. Case Temperature

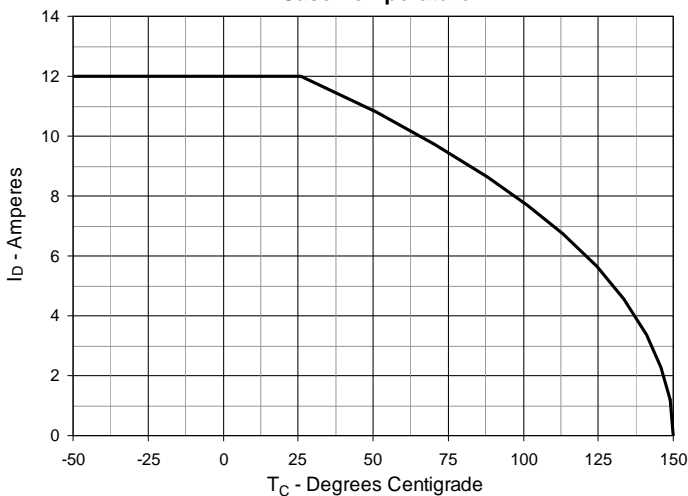

Fig. 6. Input Admittance

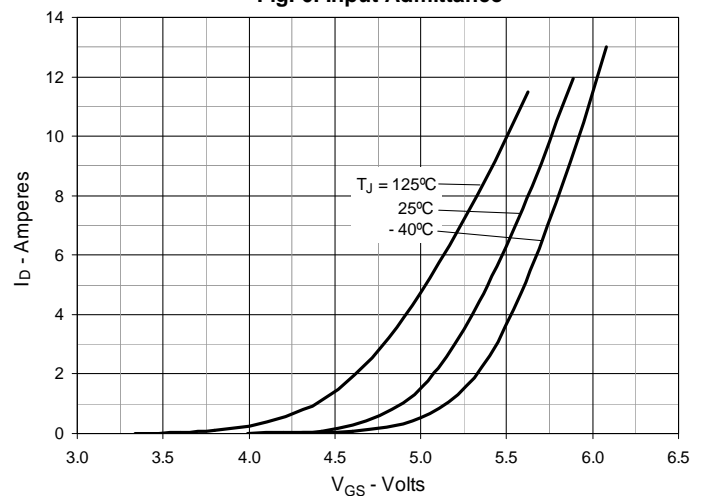

Fig. 7. Transconductance

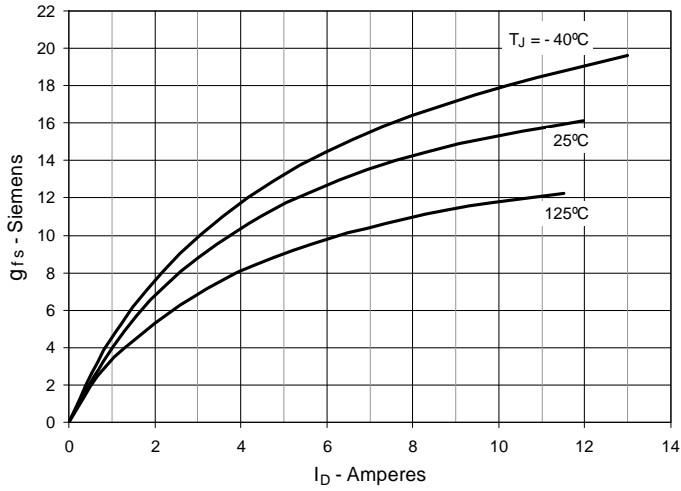

Fig. 8. Forward Voltage Drop of Intrinsic Diode

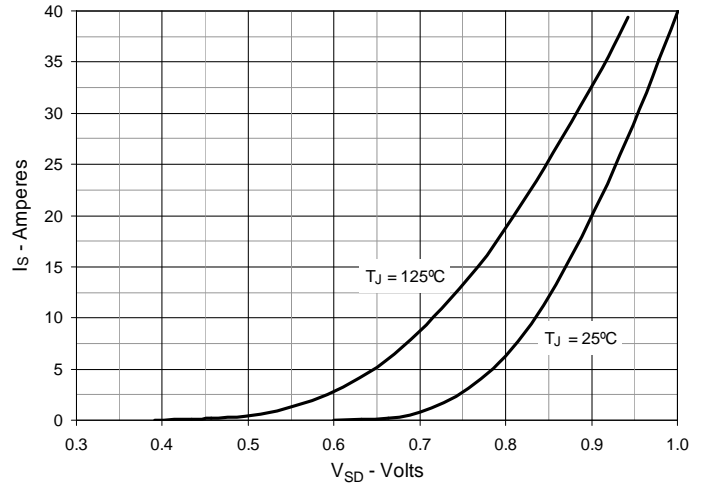

Fig. 9. Gate Charge

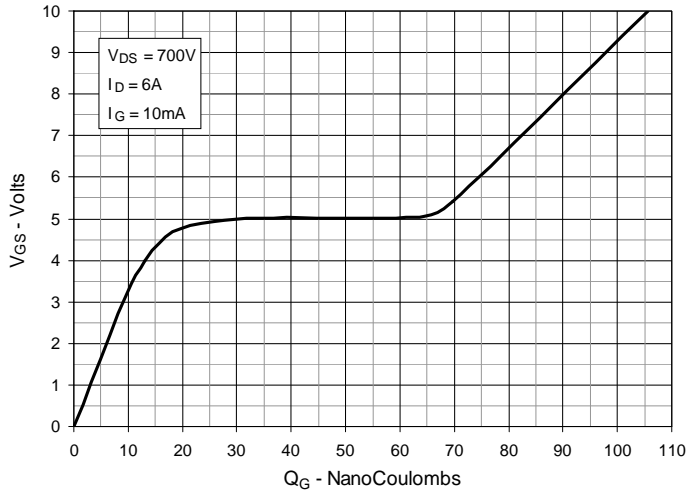

Fig. 10. Capacitance

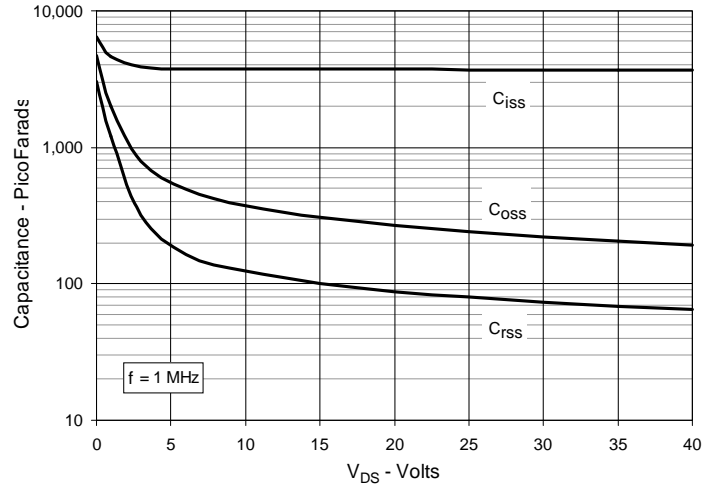

Fig. 11. Forward-Bias Safe Operating Area

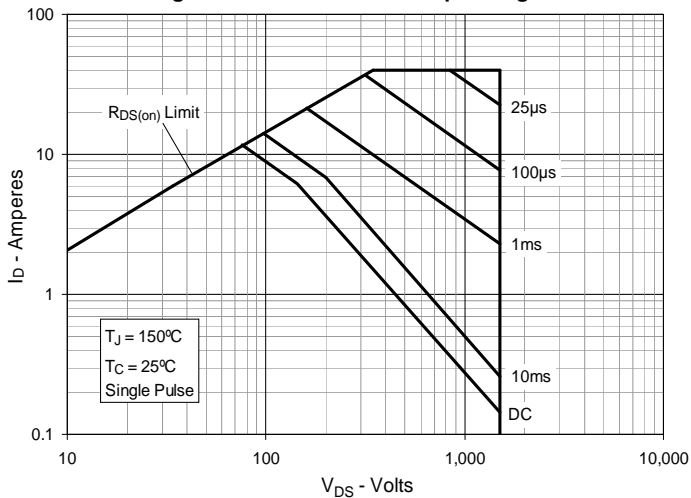
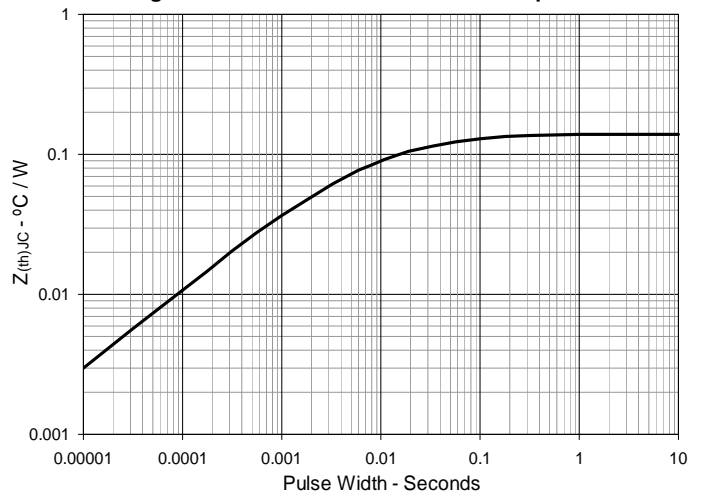

Fig. 12. Maximum Transient Thermal Impedance





Disclaimer Notice - Information furnished is believed to be accurate and reliable. However, users should independently evaluate the suitability of and test each product selected for their own applications. Littelfuse products are not designed for, and may not be used in, all applications. Read complete Disclaimer Notice at www.littelfuse.com/disclaimer-electronics.