

Polar™ Power MOSFET

IXTU5N50P
IXTY5N50P
IXTA5N50P
IXTP5N50P

N-Channel Enhancement Mode
Avalanche Rated



$V_{DSS} = 500V$
 $I_{D25} = 5A$
 $R_{DS(on)} \leq 1.4\Omega$

| Symbol | Test Conditions | Maximum Ratings | |
|---------------|--|--------------------|------------|
| V_{DSS} | $T_J = 25^\circ C$ to $150^\circ C$ | 500 | V |
| V_{DGR} | $T_J = 25^\circ C$ to $150^\circ C$, $R_{GS} = 1M\Omega$ | 500 | V |
| V_{GSS} | Continuous | ± 30 | V |
| V_{GSM} | Transient | ± 40 | V |
| I_{D25} | $T_C = 25^\circ C$ | 5 | A |
| I_{DM} | $T_C = 25^\circ C$, Pulse Width Limited by T_{JM} | 10 | A |
| I_A | $T_C = 25^\circ C$ | 5 | A |
| E_{AS} | $T_C = 25^\circ C$ | 250 | mJ |
| dv/dt | $I_S \leq I_{DM}$, $V_{DD} \leq V_{DSS}$, $T_J \leq 150^\circ C$ | 10 | V/ns |
| P_D | $T_C = 25^\circ C$ | 90 | W |
| T_J | | -55 ... +150 | $^\circ C$ |
| T_{JM} | | 150 | $^\circ C$ |
| T_{stg} | | -55 ... +150 | $^\circ C$ |
| T_L | Maximum Lead Temperature for Soldering | 300 | $^\circ C$ |
| T_{SOLD} | 1.6 mm (0.062in.) from Case for 10s | 260 | $^\circ C$ |
| F_C | Mounting Force (TO-263 & TO-251) | 10..65 / 2.2..14.6 | N/lb |
| M_d | Mounting Torque (TO-220) | 1.13 / 10 | Nm/lb.in |
| Weight | TO-251 | 0.40 | g |
| | TO-252 | 0.35 | g |
| | TO-263 | 2.50 | g |
| | TO-220 | 3.00 | g |

| Symbol | Test Conditions ($T_J = 25^\circ C$, Unless Otherwise Specified) | Characteristic Values | | |
|--------------|---|-----------------------|------|-------------------------|
| | | Min. | Typ. | Max. |
| BV_{DSS} | $V_{GS} = 0V$, $I_D = 250\mu A$ | 500 | | V |
| $V_{GS(th)}$ | $V_{DS} = V_{GS}$, $I_D = 50\mu A$ | 3.0 | | 5.5 V |
| I_{GSS} | $V_{GS} = \pm 30V$, $V_{DS} = 0V$ | | | ± 100 nA |
| I_{DSS} | $V_{DS} = V_{DSS}$, $V_{GS} = 0V$ $T_J = 125^\circ C$ | | | 5 μA 25 μA |
| $R_{DS(on)}$ | $V_{GS} = 10V$, $I_D = 0.5 \cdot I_{D25}$, Note 1 | | | 1.4 Ω |

TO-251 (IXTU)

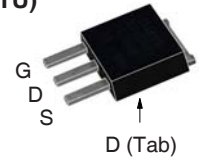

TO-252 (IXTY)

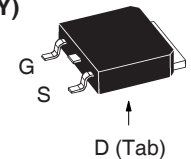

TO-263 (IXTA)

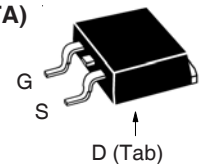

TO-220 (IXTP)

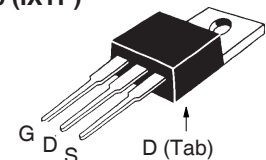

G = Gate D = Drain
S = Source Tab = Drain

Features

- International Standard Packages
- Low Q_G
- Avalanche Rated
- Low Package Inductance
- Fast Intrinsic Rectifier

Advantages

- High Power Density
- Easy to Mount
- Space Savings

Applications

- DC-DC Converters
- Switch-Mode and Resonant-Mode Power Supplies
- AC and DC Motor Drives
- Discharge Circuits in Lasers, Spark Igniters, RF Generators
- High Voltage Pulse Power Applications

| Symbol | Test Conditions ($T_J = 25^\circ\text{C}$, Unless Otherwise Specified) | Characteristic Values | | |
|--------------|---|-----------------------|------|------------------------|
| | | Min. | Typ. | Max |
| g_{fs} | $V_{DS} = 10\text{V}$, $I_D = 0.5 \cdot I_{D25}$, Note 1 | 3.0 | 4.7 | S |
| C_{iss} | $V_{GS} = 0\text{V}$, $V_{DS} = 25\text{V}$, $f = 1\text{MHz}$ | | 620 | pF |
| C_{oss} | | | 72 | pF |
| C_{rss} | | | 6.3 | pF |
| $Q_{g(on)}$ | $V_{GS} = 10\text{V}$, $V_{DS} = 0.5 \cdot V_{DSS}$, $I_D = 0.5 \cdot I_{D25}$ | | 12.6 | nC |
| Q_{gs} | | | 4.3 | nC |
| Q_{gd} | | | 5.0 | nC |
| $t_{d(on)}$ | Resistive Switching Times $V_{GS} = 10\text{V}$, $V_{DS} = 0.5 \cdot V_{DSS}$, $I_D = 0.5 \cdot I_{D25}$ $R_G = 30\Omega$ (External) | | 22 | ns |
| t_r | | | 26 | ns |
| $t_{d(off)}$ | | | 65 | ns |
| t_f | | | 24 | ns |
| R_{thJC} | TO-220 | | | 1.4 $^\circ\text{C/W}$ |
| R_{thCS} | | 0.50 | | $^\circ\text{C/W}$ |

Source-Drain Diode

| Symbol | Test Conditions ($T_J = 25^\circ\text{C}$, Unless Otherwise Specified) | Characteristic Values | | |
|----------|--|-----------------------|------|-------|
| | | Min. | Typ. | Max |
| I_S | $V_{GS} = 0\text{V}$ | | | 5 A |
| I_{SM} | Repetitive, Pulse Width Limited by T_{JM} | | | 15 A |
| V_{SD} | $I_F = I_S$, $V_{GS} = 0\text{V}$, Note 1 | | | 1.5 V |
| t_{rr} | $I_F = 5\text{A}$, $-di/dt = 100\text{A}/\mu\text{s}$, $V_R = 100\text{V}$ | | 400 | ns |

Note 1. Pulse test, $t \leq 300\mu\text{s}$, duty cycle, $d \leq 2\%$.

IXYS Reserves the Right to Change Limits, Test Conditions, and Dimensions.

| | | | | | | | | | | |
|--|-----------|-----------|-----------|-----------|-------------|-------------|-------------|-------------|-------------|-------------|
| IXYS MOSFETs and IGBTs are covered by one or more of the following U.S. patents: | 4,835,592 | 4,931,844 | 5,049,961 | 5,237,481 | 6,162,665 | 6,404,065B1 | 6,683,344 | 6,727,585 | 7,005,734B2 | 7,157,338B2 |
| | 4,860,072 | 5,017,508 | 5,063,307 | 5,381,025 | 6,259,123B1 | 6,534,343 | 6,710,405B2 | 6,759,692 | 7,063,975B2 | |
| | 4,881,106 | 5,034,796 | 5,187,117 | 5,486,715 | 6,306,728B1 | 6,583,505 | 6,710,463 | 6,771,478B2 | 7,071,537 | |

Fig. 1. Output Characteristics @ $T_J = 25^\circ\text{C}$

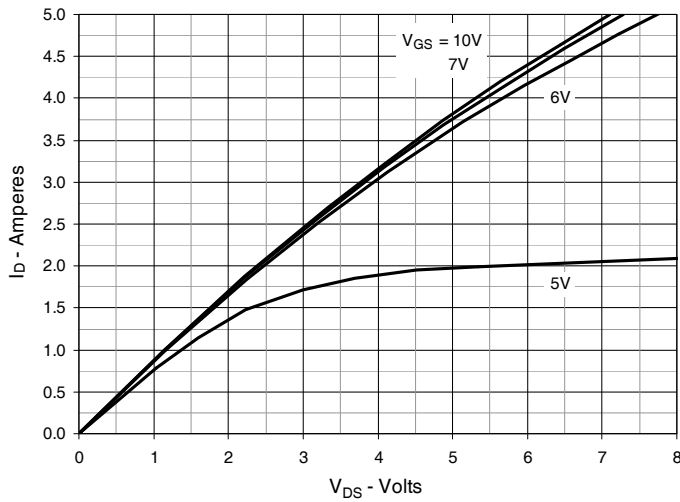

Fig. 2. Extended Output Characteristics @ $T_J = 25^\circ\text{C}$

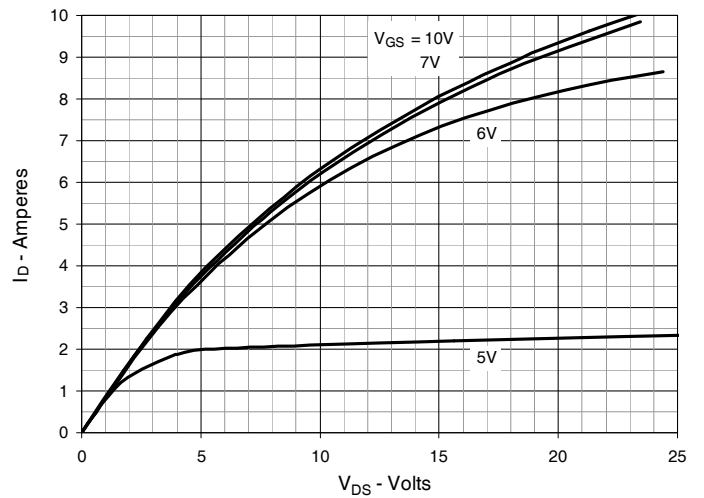

Fig. 3. Output Characteristics @ $T_J = 125^\circ\text{C}$

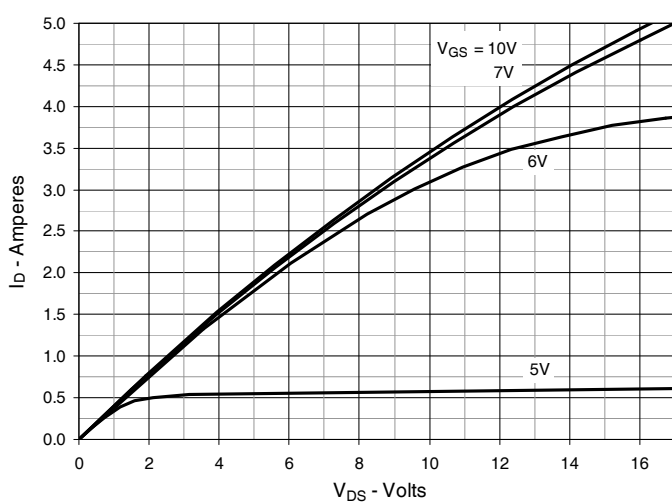

Fig. 4. $R_{DS(on)}$ Normalized to $I_D = 2.5\text{A}$ Value vs. Junction Temperature

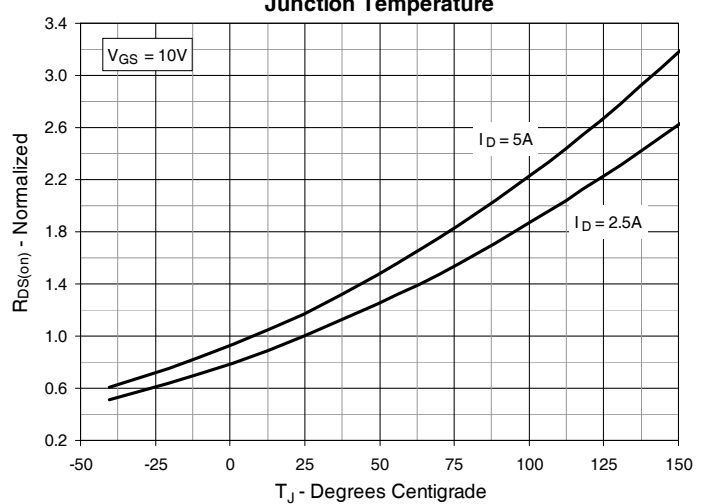

Fig. 5. $R_{DS(on)}$ Normalized to $I_D = 2.5\text{A}$ Value vs. Drain Current

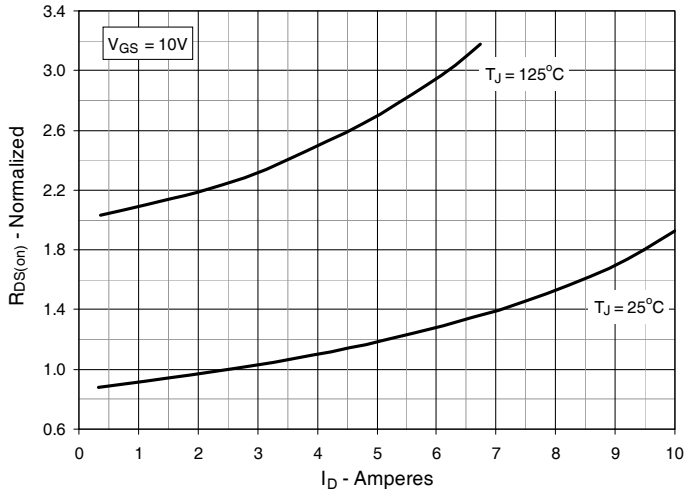

Fig. 6. Maximum Drain Current vs. Case Temperature

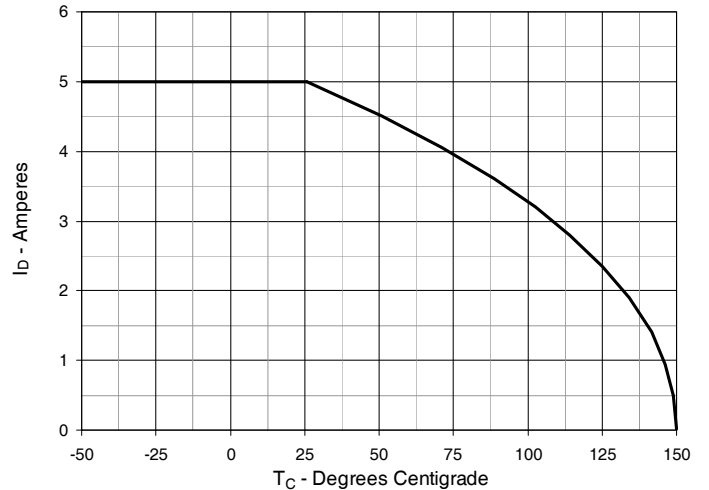

Fig. 7. Input Admittance

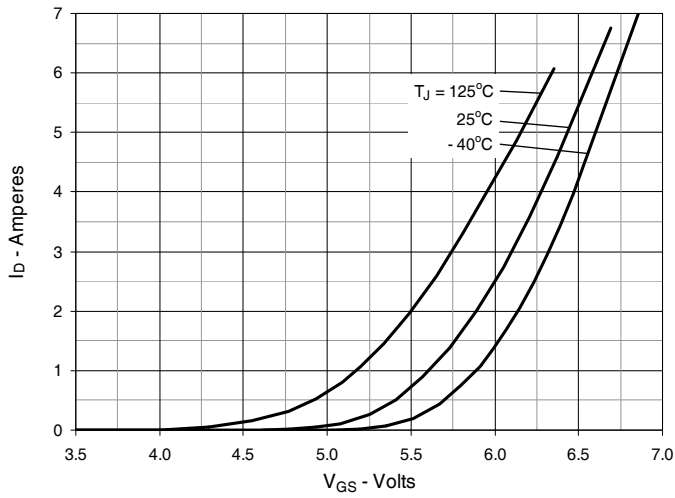

Fig. 8. Transconductance

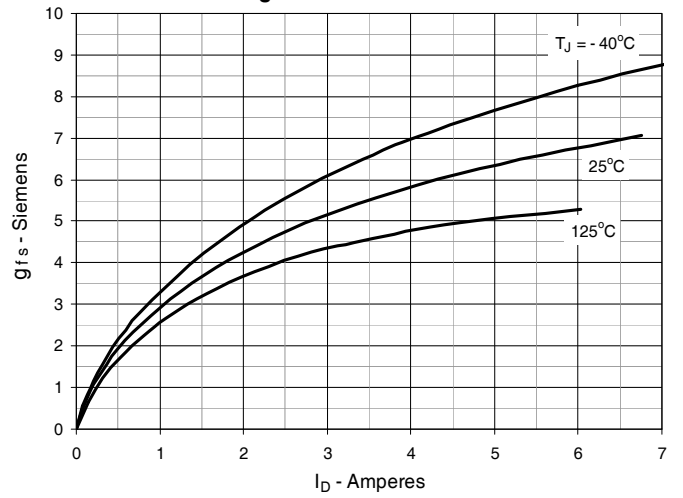

Fig. 9. Forward Voltage Drop of Intrinsic Diode

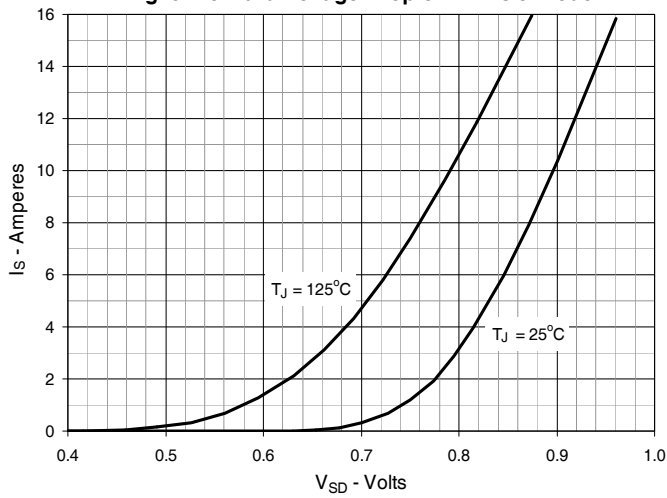

Fig. 10. Gate Charge

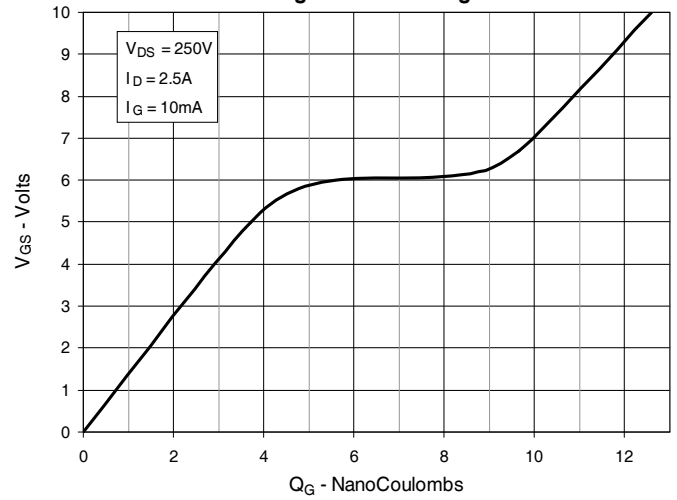

Fig. 11. Capacitance

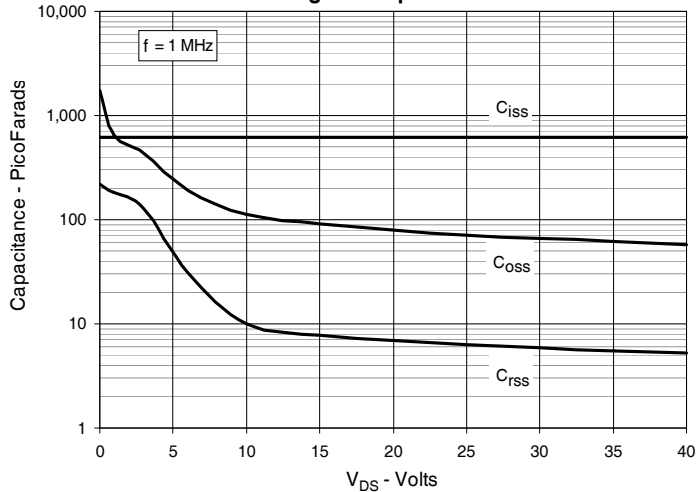

Fig. 12. Forward-Bias Safe Operating Area

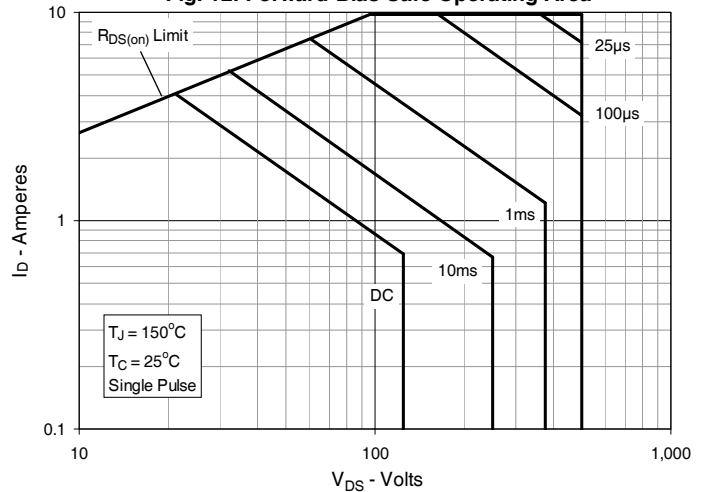
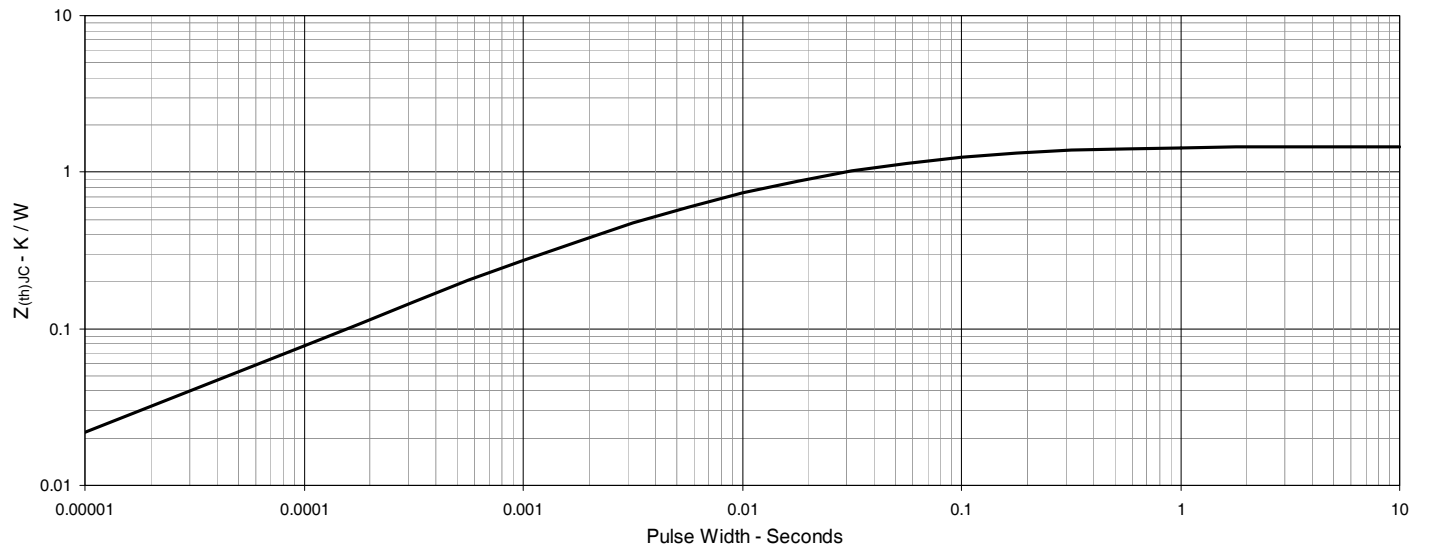
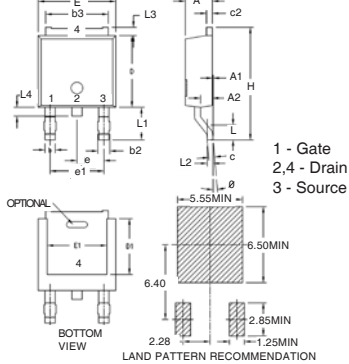

Fig. 13. Maximum Transient Thermal Impedance



TO-252 AA Outline



| SYM | INCHES | | MILLIMETERS | |
|-----|----------|------|-------------|-------|
| | MIN | MAX | MIN | MAX |
| A | .086 | .094 | 2.19 | 2.38 |
| A1 | 0 | .005 | 0 | 0.12 |
| A2 | .038 | .046 | 0.97 | 1.17 |
| b | .025 | .035 | 0.64 | 0.89 |
| b2 | .030 | .045 | 0.76 | 1.14 |
| b3 | .200 | .215 | 5.08 | 5.46 |
| c | .018 | .024 | 0.46 | 0.61 |
| c2 | .018 | .023 | 0.46 | 0.58 |
| D | .235 | .245 | 5.97 | 6.22 |
| D1 | .180 | .205 | 4.57 | 5.21 |
| E | .250 | .265 | 6.35 | 6.73 |
| E1 | .170 | .205 | 4.32 | 5.21 |
| e | .090 BSC | | 2.28 BSC | |
| e1 | .180 BSC | | 4.57 BSC | |
| H | .370 | .410 | 9.40 | 10.42 |
| L | .055 | .070 | 1.40 | 1.78 |
| L1 | .100 | .115 | 2.54 | 2.92 |
| L2 | .020 BSC | | 0.50 BSC | |
| L3 | .025 | .040 | 0.64 | 1.02 |
| L4 | .025 | .040 | 0.64 | 1.02 |
| θ | 0° - 10° | | 0° - 10° | |

TO-263 Outline

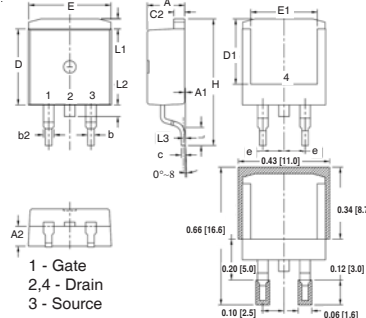

| SYM | INCHES | | MILLIMETER | |
|-----|----------|------|------------|-------|
| | MIN | MAX | MIN | MAX |
| A | .170 | .185 | 4.30 | 4.70 |
| A1 | .000 | .008 | 0.00 | 0.20 |
| A2 | .091 | .098 | 2.30 | 2.50 |
| b | .028 | .035 | 0.70 | 0.90 |
| b2 | .046 | .060 | 1.18 | 1.52 |
| C | .018 | .024 | 0.45 | 0.60 |
| C2 | .049 | .060 | 1.25 | 1.52 |
| D | .340 | .370 | 8.63 | 9.40 |
| D1 | .300 | .327 | 7.62 | 8.30 |
| E | .380 | .410 | 9.65 | 10.41 |
| E1 | .270 | .330 | 6.86 | 8.38 |
| e | .100 BSC | | 2.54 BSC | |
| H | .580 | .620 | 14.73 | 15.75 |
| L | .075 | .105 | 1.91 | 2.67 |
| L1 | .039 | .060 | 1.00 | 1.52 |
| L2 | — | .070 | — | 1.77 |
| L3 | .010 BSC | | 0.254 BSC | |

TO-220 Outline

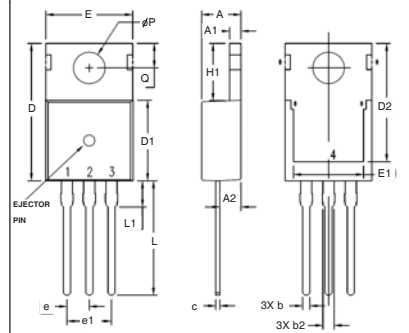

| SYM | INCHES | | MILLIMETERS | |
|------|----------|------|-------------|-------|
| | MIN | MAX | MIN | MAX |
| A | .169 | .185 | 4.30 | 4.70 |
| A1 | .047 | .055 | 1.20 | 1.40 |
| A2 | .079 | .106 | 2.00 | 2.70 |
| b | .024 | .039 | 0.60 | 1.00 |
| b2 | .045 | .057 | 1.15 | 1.45 |
| c | .014 | .026 | 0.35 | 0.65 |
| D | .587 | .626 | 14.90 | 15.90 |
| D1 | .335 | .370 | 8.50 | 9.40 |
| (D2) | .500 | .531 | 12.70 | 13.50 |
| E | .382 | .406 | 9.70 | 10.30 |
| (E1) | .283 | .323 | 7.20 | 8.20 |
| e | .100 BSC | | 2.54 BSC | |
| e1 | .200 BSC | | 5.08 BSC | |
| H1 | .244 | .268 | 6.20 | 6.80 |
| L | .492 | .547 | 12.50 | 13.90 |
| L1 | .110 | .154 | 2.80 | 3.90 |
| ∅P | .134 | .150 | 3.40 | 3.80 |
| Q | .106 | .126 | 2.70 | 3.20 |

TO-251 OUTLINE

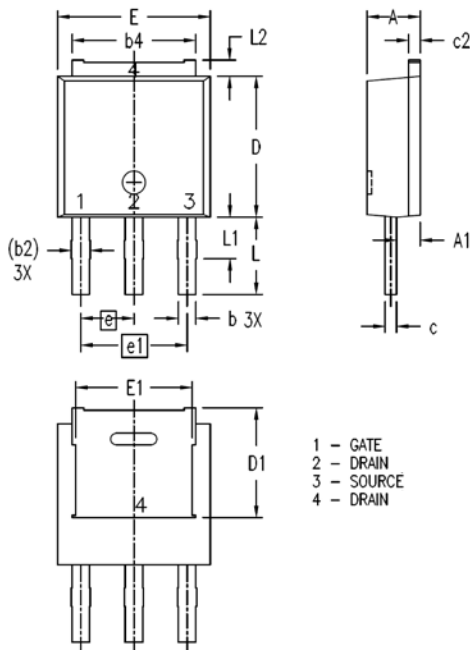

| SYM | INCHES | | MILLIMETERS | |
|------|----------|------|-------------|------|
| | MIN | MAX | MIN | MAX |
| A | .087 | .094 | 2.20 | 2.40 |
| A1 | .032 | .048 | 0.82 | 1.22 |
| b | .026 | .034 | 0.66 | 0.86 |
| (b2) | .030 | .035 | 0.76 | 0.88 |
| b4 | .198 | .222 | 5.04 | 5.64 |
| c | .018 | .024 | 0.45 | 0.60 |
| c2 | .016 | .024 | 0.40 | 0.60 |
| D | .232 | .248 | 5.90 | 6.30 |
| (D1) | .179 | .195 | 4.55 | 4.95 |
| E | .252 | .268 | 6.40 | 6.80 |
| (E1) | .191 | .207 | 4.85 | 5.25 |
| e | .090 BSC | | 2.28 BSC | |
| e1 | .180 BSC | | 4.57 BSC | |
| L | .126 | .138 | 3.20 | 3.50 |
| L1 | .063 | .079 | 1.60 | 2.00 |
| L2 | .020 | .035 | 0.50 | 0.90 |



Disclaimer Notice - Information furnished is believed to be accurate and reliable. However, users should independently evaluate the suitability of and test each product selected for their own applications. Littelfuse products are not designed for, and may not be used in, all applications. Read complete Disclaimer Notice at www.littelfuse.com/disclaimer-electronics.