

Polar™
Power MOSFET

IXTA3N100P
IXTP3N100P
IXTH3N100P

$V_{DSS} = 1000V$
 $I_{D25} = 3A$
 $R_{DS(on)} \leq 4.8\Omega$

N-Channel Enhancement Mode
Avalanche Rated



Symbol	Test Conditions	Maximum Ratings	
V_{DSS}	$T_J = 25^\circ C$ to $150^\circ C$	1000	V
V_{DGR}	$T_J = 25^\circ C$ to $150^\circ C$, $R_{GS} = 1M\Omega$	1000	V
V_{GSS}	Continuous	± 20	V
V_{GSM}	Transient	± 30	V
I_{D25}	$T_C = 25^\circ C$	3	A
I_{DM}	$T_C = 25^\circ C$, Pulse Width Limited by T_{JM}	6	A
I_A	$T_C = 25^\circ C$	3	A
E_{AS}	$T_C = 25^\circ C$	200	mJ
dv/dt	$I_S \leq I_{DM}$, $V_{DD} \leq V_{DSS}$, $T_J \leq 150^\circ C$	10	V/ns
P_D	$T_C = 25^\circ C$	125	W
T_J		-55 ... +150	$^\circ C$
T_{JM}		150	$^\circ C$
T_{stg}		-55 ... +150	$^\circ C$
T_L	Maximum Lead Temperature for Soldering	300	$^\circ C$
T_{SOLD}	1.6 mm (0.062in.) from Case for 10s	260	$^\circ C$
F_C	Mounting Force (TO-263)	10..65 / 2.2..14.6	N/lb
M_d	Mounting Torque (TO-220 & TO-247)	1.13 / 10	Nm/lb.in
Weight	TO-263	2.5	g
	TO-220	3.0	g
	TO-247	6.0	g

TO-263 (IXTA)

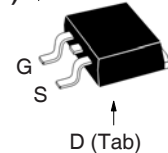

TO-220 (IXTP)

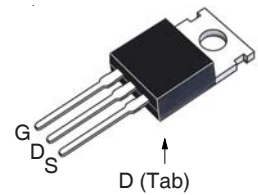

TO-247 (IXTH)

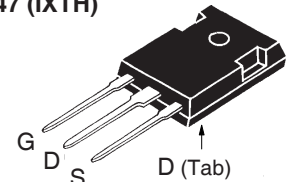

G = Gate D = Drain
S = Source Tab = Drain

Features

- International Standard Packages
- Low $R_{DS(ON)}$ and Q_G
- Avalanche Rated
- Low Package Inductance

Advantages

- High Power Density
- Easy to Mount
- Space Savings

Applications

- Switch-Mode and Resonant-Mode Power Supplies
- DC-DC Converters
- Laser Drivers
- AC and DC Motor Drives
- Robotics and Servo Controls

Symbol	Test Conditions ($T_J = 25^\circ C$, Unless Otherwise Specified)	Characteristic Values		
		Min.	Typ.	Max.
BV_{DSS}	$V_{GS} = 0V$, $I_D = 250\mu A$	1000		V
$V_{GS(th)}$	$V_{DS} = V_{GS}$, $I_D = 250\mu A$	2.5		V
I_{GSS}	$V_{GS} = \pm 20V$, $V_{DS} = 0V$			± 50 nA
I_{DSS}	$V_{DS} = V_{DSS}$, $V_{GS} = 0V$ $T_J = 125^\circ C$			5 μA 250 μA
$R_{DS(on)}$	$V_{GS} = 10V$, $I_D = 0.5 \cdot I_{D25}$, Note 1			4.8 Ω

Symbol	Test Conditions ($T_J = 25^\circ\text{C}$, Unless Otherwise Specified)	Characteristic Values		
		Min.	Typ.	Max
g_{fs}	$V_{DS} = 20\text{V}$, $I_D = 0.5 \cdot I_{D25}$, Note 1	1.5	2.4	S
C_{iss}	$V_{GS} = 0\text{V}$, $V_{DS} = 25\text{V}$, $f = 1\text{MHz}$		1100	pF
C_{oss}			70	pF
C_{rss}			14.5	pF
$t_{d(on)}$	Resistive Switching Times $V_{GS} = 10\text{V}$, $V_{DS} = 0.5 \cdot V_{DSS}$, $I_D = 0.5 \cdot I_{D25}$ $R_G = 18\Omega$ (External)		22	ns
t_r			27	ns
$t_{d(off)}$			75	ns
t_f			29	ns
$Q_{g(on)}$	$V_{GS} = 10\text{V}$, $V_{DS} = 0.5 \cdot V_{DSS}$, $I_D = 0.5 \cdot I_{D25}$		36	nC
Q_{gs}			9	nC
Q_{gd}			13	nC
R_{thJC}	TO-220 TO-247			1.0 $^\circ\text{C/W}$
R_{thCS}			0.50 0.21	$^\circ\text{C/W}$ $^\circ\text{C/W}$

Source-Drain Diode

Symbol	Test Conditions ($T_J = 25^\circ\text{C}$, Unless Otherwise Specified)	Characteristic Values		
		Min.	Typ.	Max
I_S	$V_{GS} = 0\text{V}$			3 A
I_{SM}	Repetitive, pulse Width Limited by T_{JM}			9 A
V_{SD}	$I_F = I_S$, $V_{GS} = 0\text{V}$, Note 1			1.5 V
t_{rr}	$I_F = 3\text{A}$, $-di/dt = 100\text{A}/\mu\text{s}$ $V_R = 100\text{V}$		820	ns

Note 1. Pulse test, $t \leq 300\mu\text{s}$, duty cycle, $d \leq 2\%$.

IXYS Reserves the Right to Change Limits, Test Conditions, and Dimensions.

IXYS MOSFETs and IGBTs are covered by one or more of the following U.S. patents:	4,835,592	4,931,844	5,049,961	5,237,481	6,162,665	6,404,065B1	6,683,344	6,727,585	7,005,734B2	7,157,338B2
	4,860,072	5,017,508	5,063,307	5,381,025	6,259,123B1	6,534,343	6,710,405B2	6,759,692	7,063,975B2	
	4,881,106	5,034,796	5,187,117	5,486,715	6,306,728B1	6,583,505	6,710,463	6,771,478B2	7,071,537	

Fig. 1. Output Characteristics @ $T_J = 25^\circ\text{C}$

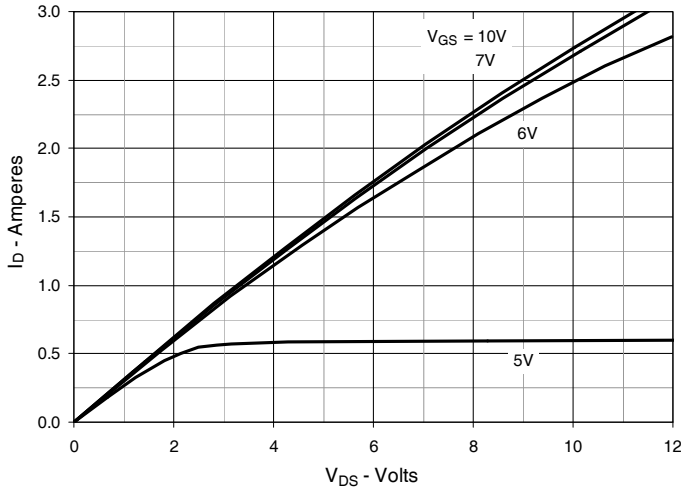

Fig. 2. Extended Output Characteristics @ $T_J = 25^\circ\text{C}$

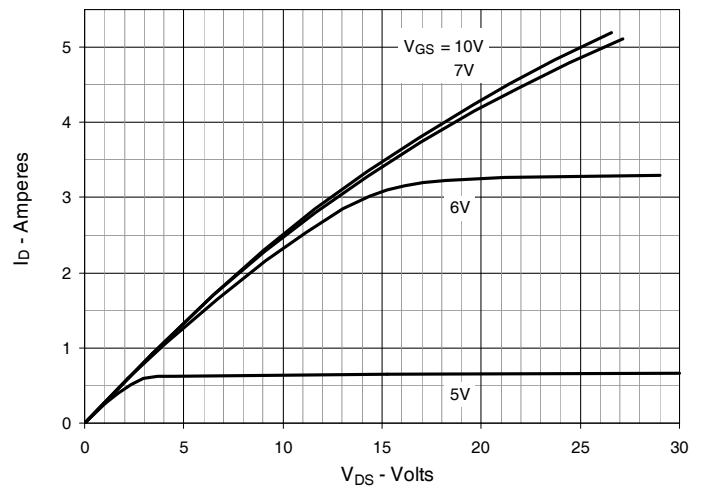

Fig. 3. Output Characteristics @ $T_J = 125^\circ\text{C}$

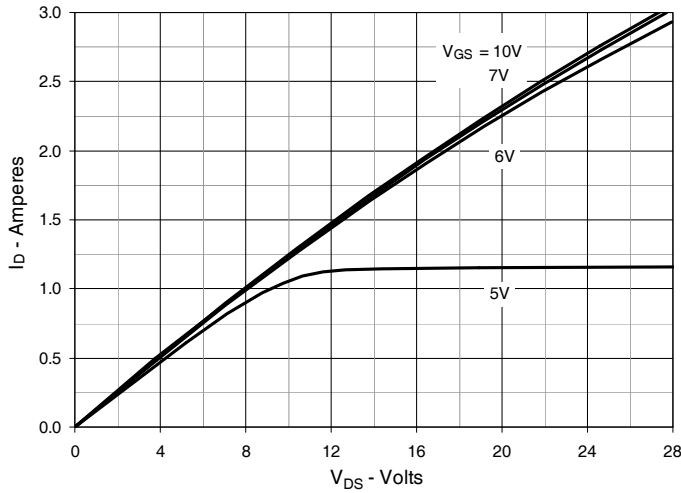

Fig. 4. $R_{DS(on)}$ Normalized to $I_D = 1.5\text{A}$ Value vs. Junction Temperature

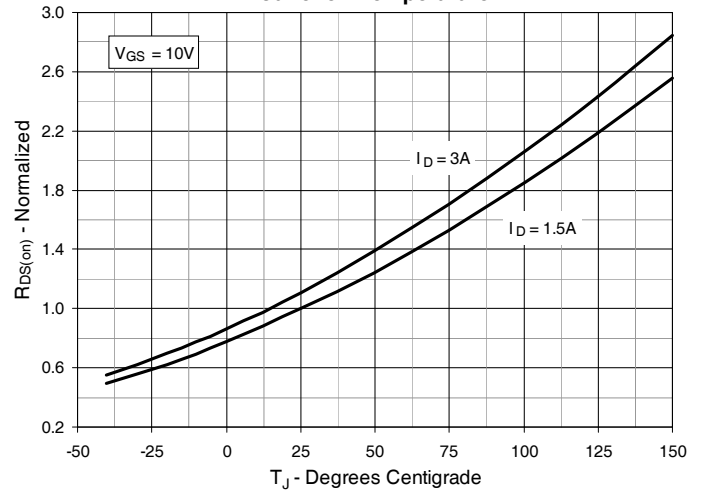

Fig. 5. $R_{DS(on)}$ Normalized to $I_D = 1.5\text{A}$ Value vs. Drain Current

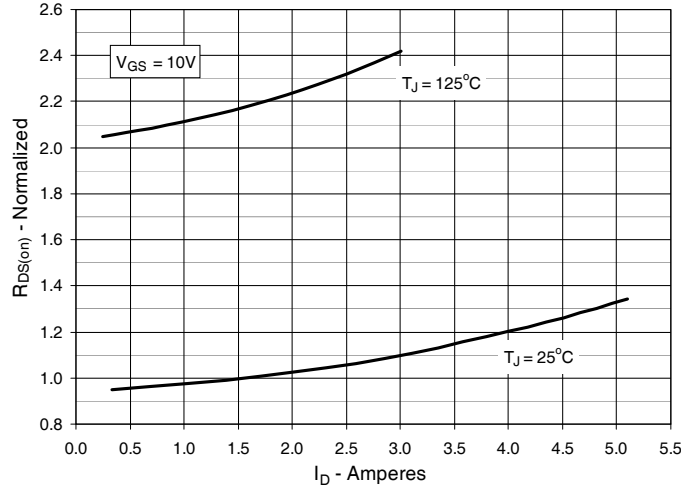

Fig. 6. Maximum Drain Current vs. Case Temperature

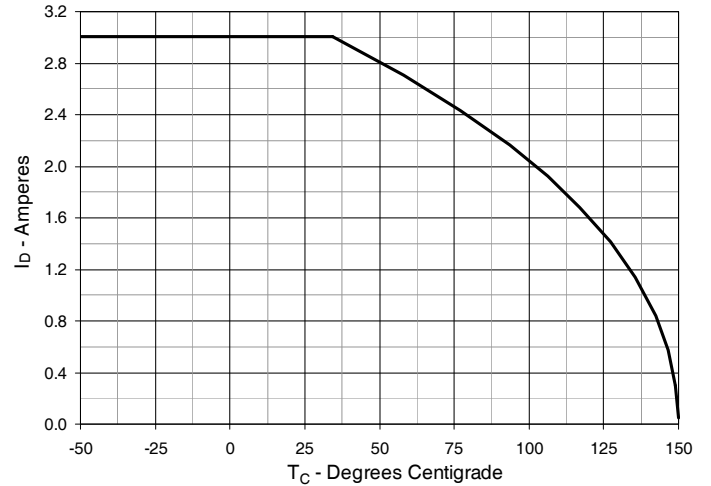

Fig. 7. Input Admittance

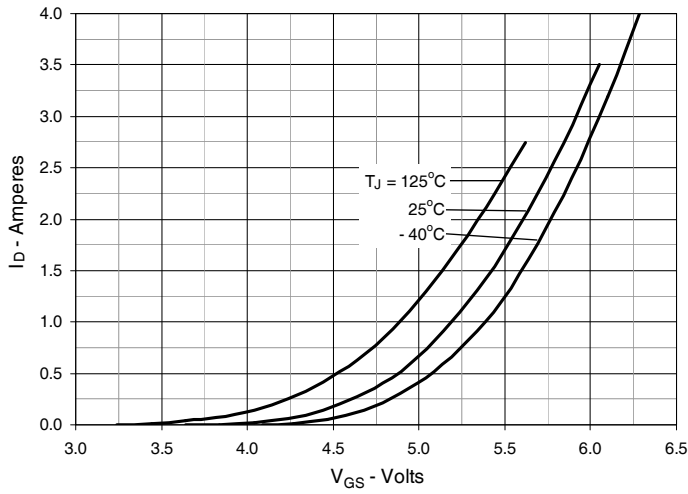

Fig. 8. Transconductance

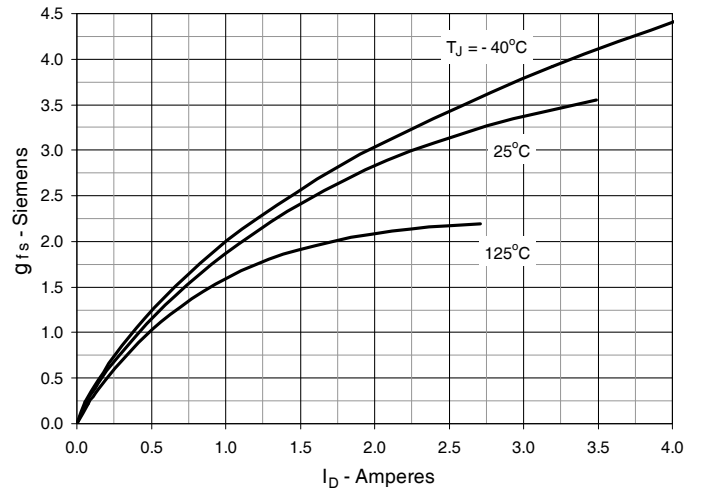

Fig. 9. Forward Voltage Drop of Intrinsic Diode

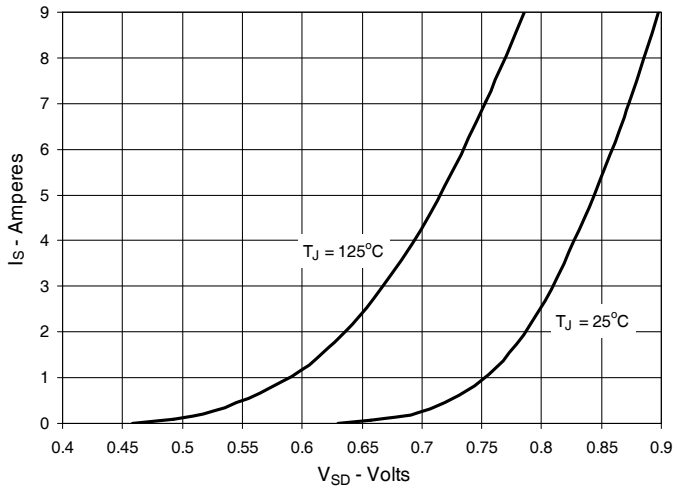

Fig. 10. Gate Charge

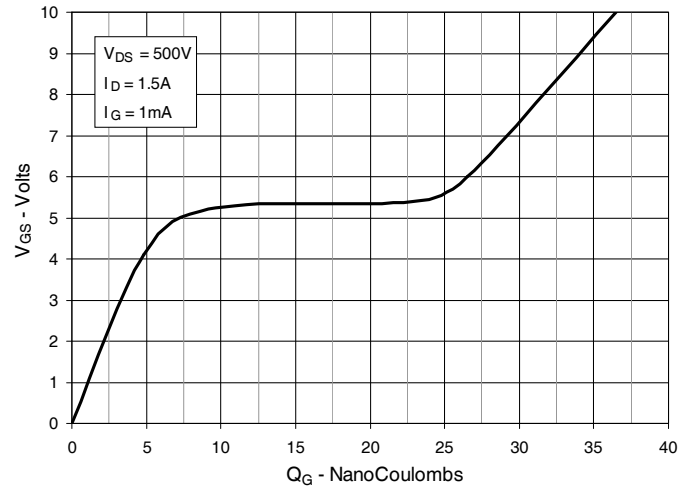

Fig. 11. Capacitance

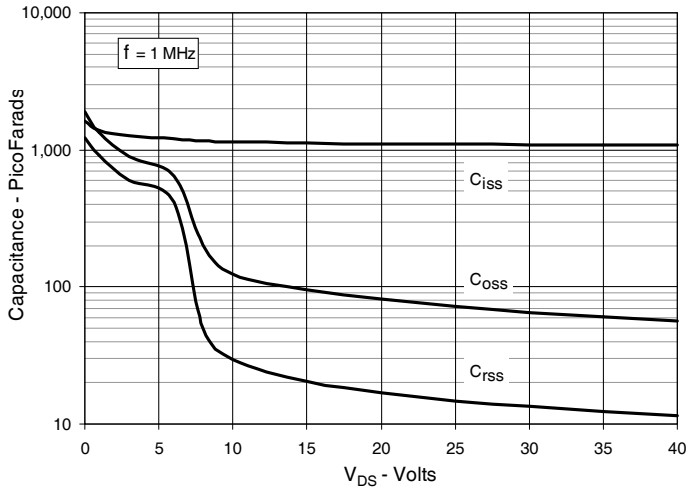

Fig. 12. Forward-Bias Safe Operating Area

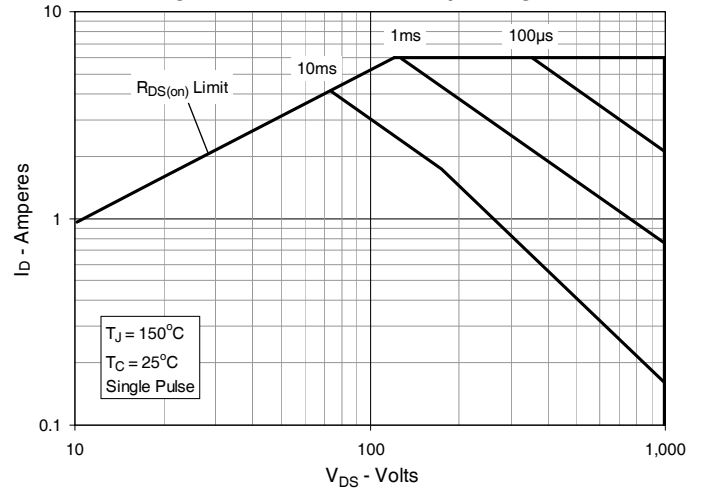
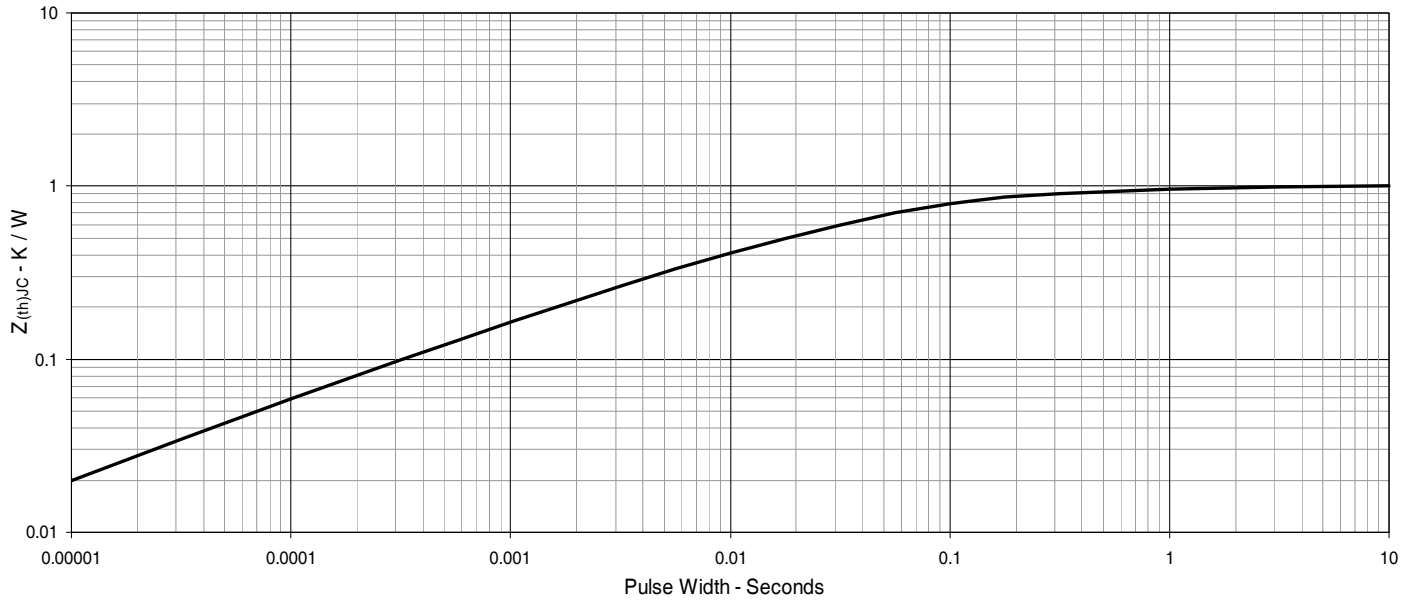
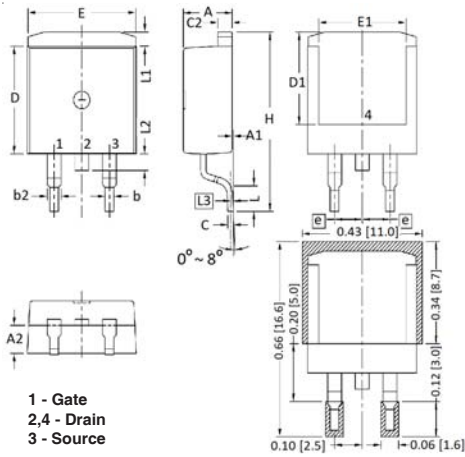

Fig. 13. Maximum Transient Thermal Impedance



TO-263 Outline



SYM	INCHES		MILLIMETER	
	MIN	MAX	MIN	MAX
A	.170	.185	4.30	4.70
A1	.000	.008	0.00	0.20
A2	.091	.098	2.30	2.50
b	.028	.035	0.70	0.90
b2	.046	.060	1.18	1.52
C	.018	.024	0.45	0.60
C2	.049	.060	1.25	1.52
D	.340	.370	8.63	9.40
D1	.300	.327	7.62	8.30
E	.380	.410	9.65	10.41
E1	.270	.330	6.86	8.38
e	.100 BSC		2.54 BSC	
H	.580	.620	14.73	15.75
L	.075	.105	1.91	2.67
L1	.039	.060	1.00	1.52
L2	—	.070	—	1.77
L3	.010 BSC		0.254 BSC	

TO-220 Outline

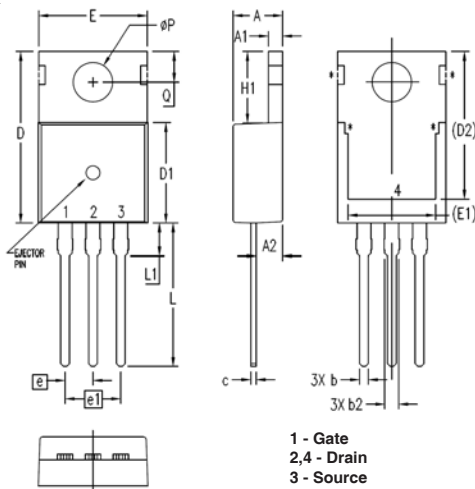

SYM	INCHES		MILLIMETERS	
	MIN	MAX	MIN	MAX
A	.169	.185	4.30	4.70
A1	.047	.055	1.20	1.40
A2	.079	.106	2.00	2.70
b	.024	.039	0.60	1.00
b2	.045	.057	1.15	1.45
c	.014	.026	0.35	0.65
D	.587	.626	14.90	15.90
D1	.335	.370	8.50	9.40
(D2)	.500	.531	12.70	13.50
E	.382	.406	9.70	10.30
(E1)	.283	.323	7.20	8.20
e	.100 BSC		2.54 BSC	
e1	.200 BSC		5.08 BSC	
H1	.244	.268	6.20	6.80
L	.492	.547	12.50	13.90
L1	.110	.154	2.80	3.90
∅P	.134	.150	3.40	3.80
Q	.106	.126	2.70	3.20

TO-247 Outline

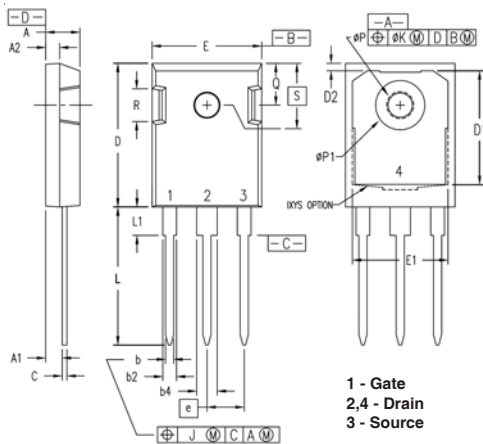

SYM	INCHES		MILLIMETERS	
	MIN	MAX	MIN	MAX
A	.190	.205	4.83	5.21
A1	.090	.100	2.29	2.54
A2	.075	.085	1.91	2.16
b	.045	.055	1.14	1.40
b2	.075	.087	1.91	2.20
b4	.115	.126	2.92	3.20
C	.024	.031	0.61	0.80
D	.819	.840	20.80	21.34
D1	.650	.690	16.51	17.53
D2	.035	.050	0.89	1.27
E	.620	.635	15.75	16.13
E1	.545	.565	13.84	14.35
e	.215 BSC		5.45 BSC	
J	—	.010	—	0.25
K	—	.025	—	0.64
L	.780	.810	19.81	20.57
L1	.150	.170	3.81	4.32
∅P	.140	.144	3.55	3.65
∅P1	.275	.290	6.99	7.37
Q	.220	.244	5.59	6.20
R	.170	.190	4.32	4.83
S	.242 BSC		6.15 BSC	



Disclaimer Notice - Information furnished is believed to be accurate and reliable. However, users should independently evaluate the suitability of and test each product selected for their own applications. Littelfuse products are not designed for, and may not be used in, all applications. Read complete Disclaimer Notice at www.littelfuse.com/disclaimer-electronics.