

**Linear™**  
**Power MOSFET**  
**w/Extended FBSOA**

**IXTK8N150L**  
**IXTX8N150L**

**V<sub>DSS</sub> = 1500V**  
**I<sub>D25</sub> = 8A**  
**R<sub>DS(on)</sub> ≤ 3.6Ω**

N-Channel Enhancement Mode  
 Guaranteed FBSOA

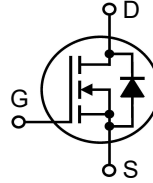

**TO-264**  
**(IXTK)**

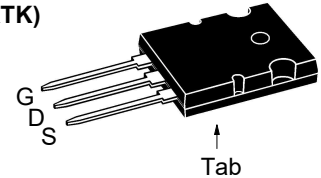

**PLUS247**  
**(IXTX)**

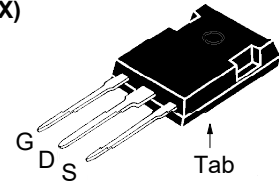

G = Gate    D = Drain  
 S = Source    Tab = Drain

Symbol	Test Conditions	Maximum Ratings	
V <sub>DSS</sub>	T <sub>J</sub> = 25°C to 150°C	1500	V
V <sub>DGR</sub>	T <sub>J</sub> = 25°C to 150°C, R <sub>GS</sub> = 1MΩ	1500	V
V <sub>GSS</sub>	Continuous	±30	V
V <sub>GSM</sub>	Transient	±40	V
I <sub>D25</sub>	T <sub>C</sub> = 25°C	8	A
I <sub>DM</sub>	T <sub>C</sub> = 25°C, Pulse Width Limited by T <sub>JM</sub>	20	A
P <sub>D</sub>	T <sub>C</sub> = 25°C	700	W
T <sub>J</sub>		-55 to +150	°C
T <sub>JM</sub>		150	°C
T <sub>stg</sub>		-55 to +150	°C
T <sub>L</sub>	Maximum Lead Temperature for Soldering 1.6 mm (0.062 in.) from Case for 10s	300	°C
M <sub>d</sub>	Mounting Torque (TO-264)	1.13/10	Nm/lb.in
F <sub>C</sub>	Mounting Force (PLUS247)	20..120 /4.5..27	N/lb
Weight	TO-264	10	g
	PLUS247	6	g

**Features**

- Designed for Linear Operations
- International Standard Packages
- Guaranteed FBSOA at 60°C
- Molding Epoxies Meet UL94 V-0 Flammability Classification

**Applications**

- Programmable Loads
- Current Regulators
- DC-DC Convertors
- Battery Chargers
- DC Choppers
- Temperature and Lighting Controls

**Advantages**

- Easy to Mount
- Space Savings
- High Power Density

Symbol	Test Conditions (T <sub>J</sub> = 25°C, Unless Otherwise Specified)	Characteristic Values		
		Min.	Typ.	Max.
BV <sub>DSS</sub>	V <sub>GS</sub> = 0V, I <sub>D</sub> = 1mA	1500		V
V <sub>GS(th)</sub>	V <sub>DS</sub> = V <sub>GS</sub> , I <sub>D</sub> = 250μA	5.0		V
I <sub>GSS</sub>	V <sub>GS</sub> = ±30V, V <sub>DS</sub> = 0V			±200 nA
I <sub>DSS</sub>	V <sub>DS</sub> = V <sub>DSS</sub> , V <sub>GS</sub> = 0V T <sub>J</sub> = 125°C			50 μA 3 mA
R <sub>DS(on)</sub>	V <sub>GS</sub> = 20V, I <sub>D</sub> = 0.5 • I <sub>D25</sub> , Note 1			3.6 Ω

Symbol	Test Conditions ( $T_J = 25^\circ\text{C}$ , Unless Otherwise Specified)	Characteristic Values		
		Min.	Typ.	Max.
$g_{fs}$	$V_{DS} = 50\text{V}$ , $I_D = 0.5 \cdot I_{D25}$ , Note 1	1.4	2.3	3.2 S
$C_{iss}$	$V_{GS} = 0\text{V}$ , $V_{DS} = 25\text{V}$ , $f = 1\text{MHz}$		8000	pF
$C_{oss}$			405	pF
$C_{rss}$			70	pF
$t_{d(on)}$	<b>Resistive Switching Times</b> $V_{GS} = 15\text{V}$ , $V_{DS} = 0.5 \cdot V_{DSS}$ , $I_D = 0.5 \cdot I_{D25}$ $R_G = 2\Omega$ (External)		36	ns
$t_r$			18	ns
$t_{d(off)}$			90	ns
$t_f$			95	ns
$Q_{g(on)}$			$V_{GS} = 15\text{V}$ , $V_{DS} = 0.5 \cdot V_{DSS}$ , $I_D = 0.5 \cdot I_{D25}$	
$Q_{gs}$	80	nC		
$Q_{gd}$	116	nC		
$R_{thJC}$		0.15	0.18 $^\circ\text{C/W}$	
$R_{thCS}$			$^\circ\text{C/W}$	

### Safe Operating Area Specification

Symbol	Test Conditions	Characteristic Values		
		Min.	Typ.	Max.
<b>SOA</b>	$V_{DS} = 1\text{kV}$ , $I_D = 0.5\text{A}$ , $T_C = 60^\circ\text{C}$ , $T_p = 3\text{s}$	500		W

### Source-Drain Diode

Symbol	Test Conditions ( $T_J = 25^\circ\text{C}$ , Unless Otherwise Specified)	Characteristic Values		
		Min.	Typ.	Max.
$I_s$	$V_{GS} = 0\text{V}$			8 A
$I_{SM}$	Repetitive, Pulse Width Limited by $T_{JM}$			32 A
$V_{SD}$	$I_F = 8\text{A}$ , $V_{GS} = 0\text{V}$ , Note 1			1.2 V
$t_{rr}$	$I_F = I_s$ , $-di/dt = 100\text{A}/\mu\text{s}$ , $V_R = 100\text{V}$		1700	ns

Note: 1. Pulse Test,  $t \leq 300\mu\text{s}$ ; Duty Cycle,  $d \leq 2\%$ .

Littelfuse reserves the right to change limits, test conditions, and dimensions.

IXYS MOSFETs and IGBTs are covered	4,835,592	4,931,844	5,049,961	5,237,481	6,162,665	6,404,065 B1	6,683,344	6,727,585	7,005,734 B2	7,157,338 B2
by one or more of the following U.S. patents:	4,860,072	5,017,508	5,063,307	5,381,025	6,259,123 B1	6,534,343	6,710,405 B2	6,759,692	7,063,975 B2	
	4,881,106	5,034,796	5,187,117	5,486,715	6,306,728 B1	6,583,505	6,710,463	6,771,478 B2	7,071,537	

**Fig. 1. Extended Output Characteristics @  $T_J = 25^\circ\text{C}$**

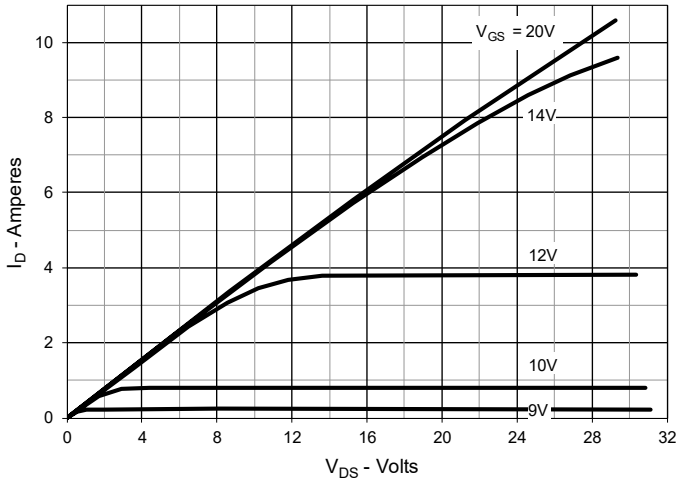

**Fig. 2. Output Characteristics @  $T_J = 125^\circ\text{C}$**

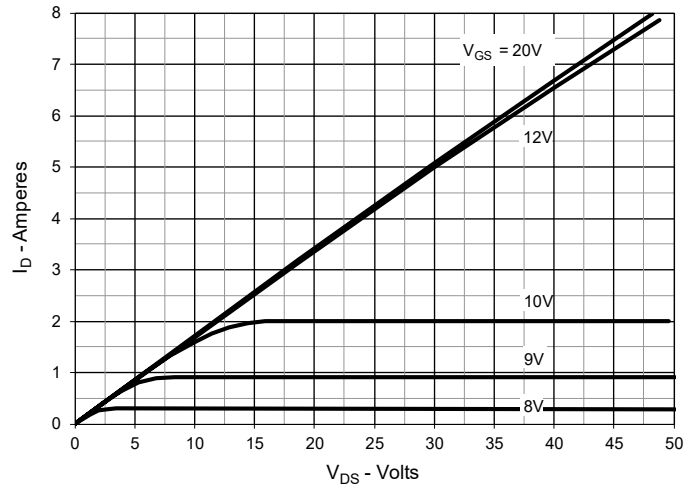

**Fig. 3.  $R_{DS(on)}$  Normalized to  $I_D = 4\text{A}$  Value vs. Junction Temperature**

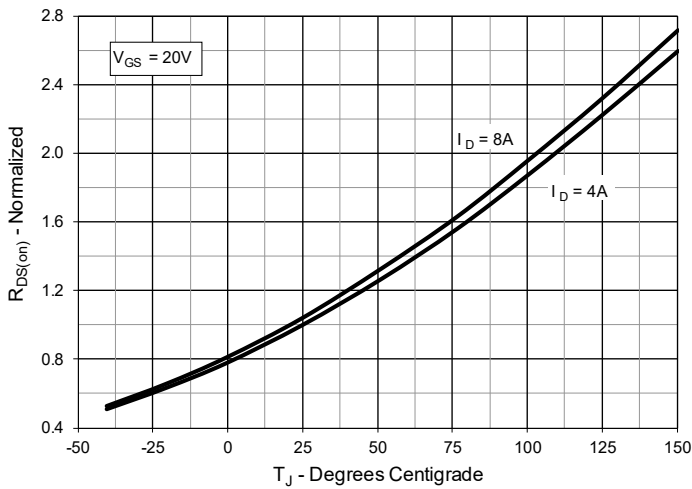

**Fig. 4.  $R_{DS(on)}$  Normalized to  $I_D = 4\text{A}$  Value vs. Drain Current**

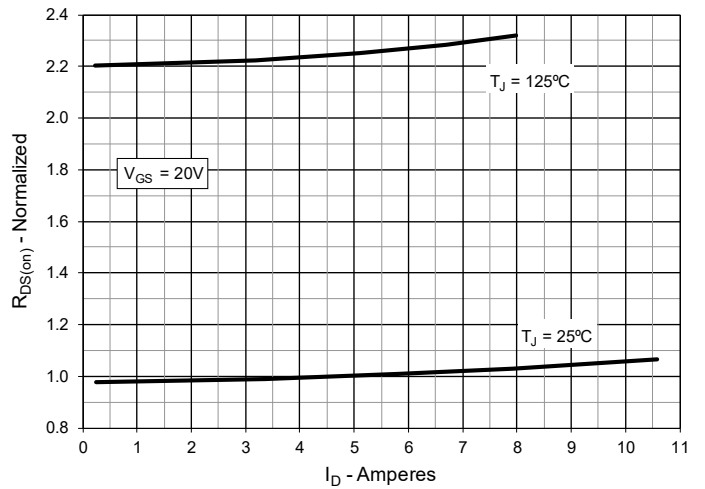

**Fig. 5. Maximum Drain Current vs. Case Temperature**

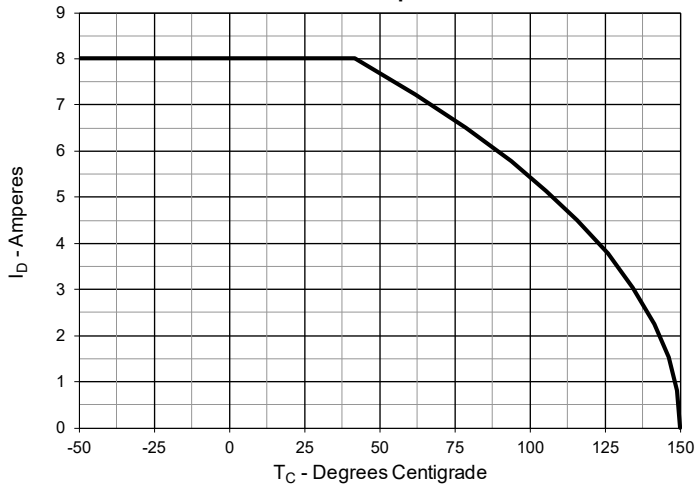

**Fig. 6. Input Admittance**

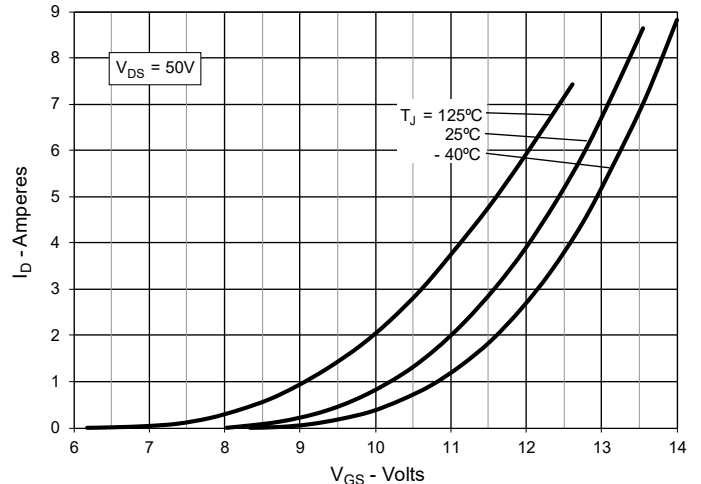

**Fig. 7. Transconductance**

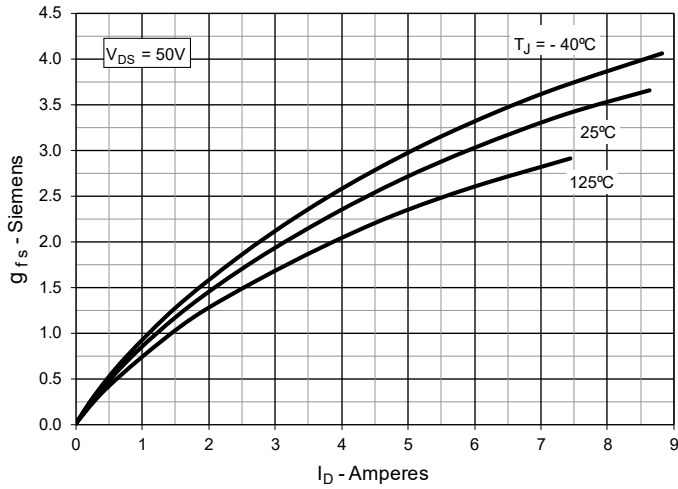

**Fig. 8. Forward Voltage Drop of Intrinsic Diode**

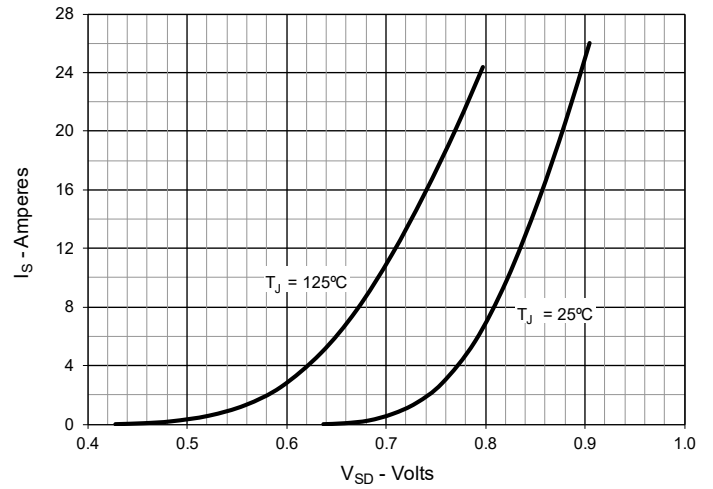

**Fig. 9. Gate Charge**

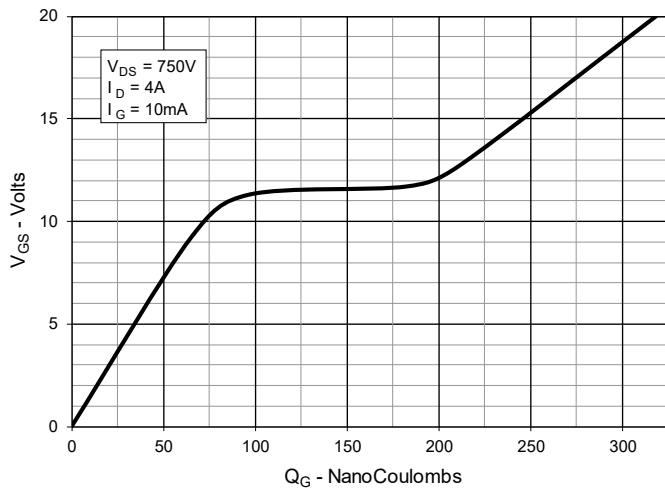

**Fig. 10. Capacitance**

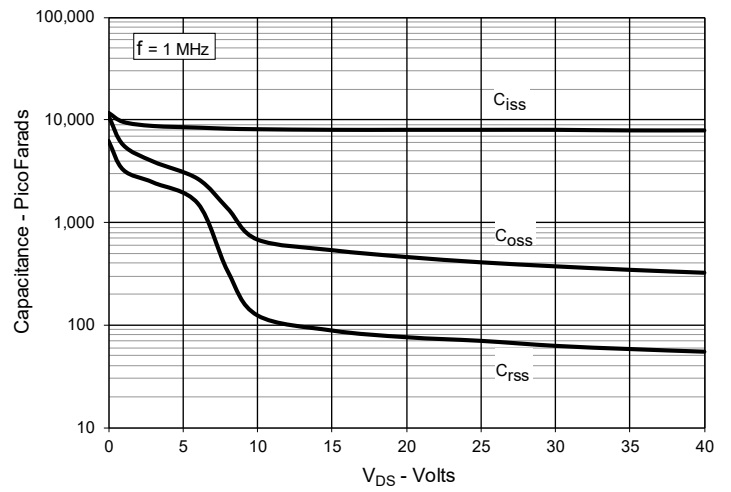

**Fig. 11. Maximum Transient Thermal Impedance**

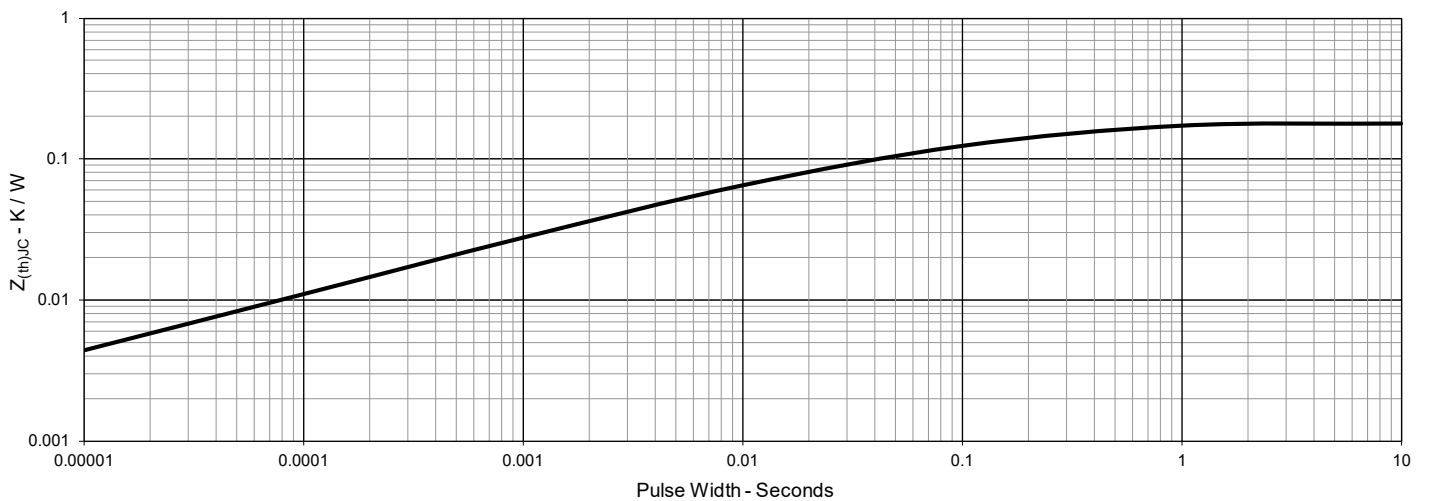

**Fig. 12. Forward-Bias Safe Operating Area**  
**@  $T_C = 25^\circ\text{C}$**

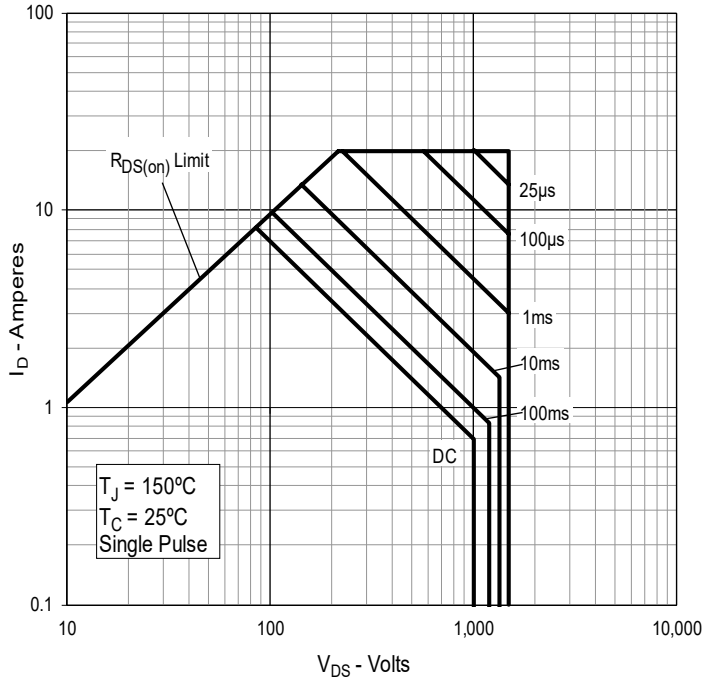

**Fig. 13. Forward-Bias Safe Operating Area**  
**@  $T_C = 60^\circ\text{C}$**

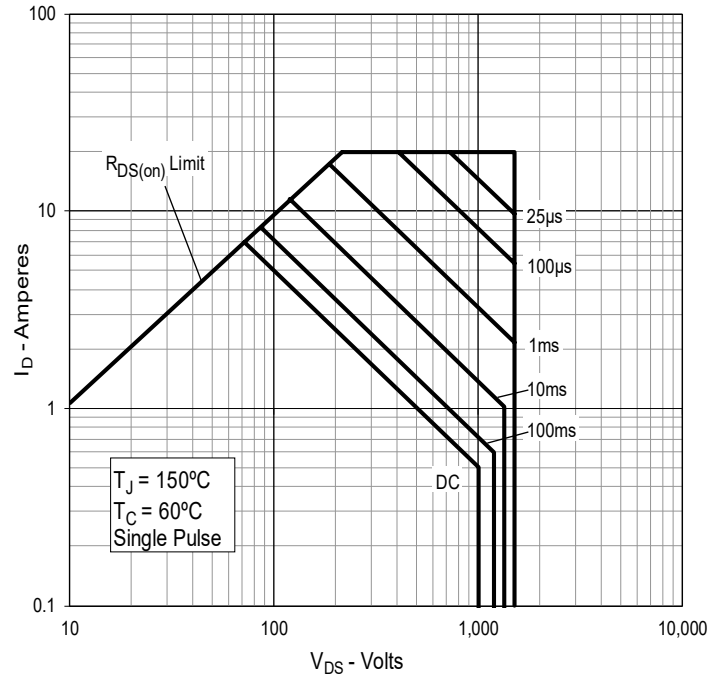

**TO-264 Outline**

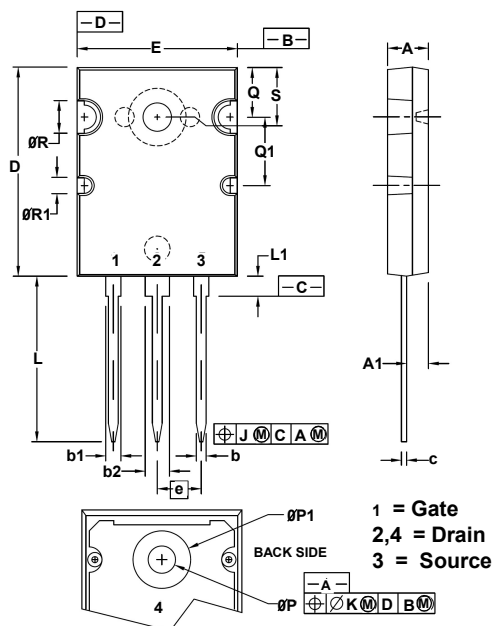

SYMBOL	INCHES		MILLIMETERS	
	MIN	MAX	MIN	MAX
A	.185	.209	4.70	5.31
A1	.102	.118	2.59	3.00
b	.037	.055	0.94	1.40
b1	.087	.102	2.21	2.59
b2	.110	.126	2.79	3.20
c	.017	.029	0.43	0.74
D	1.007	1.047	25.58	26.59
E	.760	.799	19.30	20.29
e	.215 BSC		5.46 BSC	
J	.000	.010	0.00	0.25
K	.000	.010	0.00	0.25
L	.779	.842	19.79	21.39
L1	.087	.102	2.21	2.59
øP	.122	.138	3.10	3.51
øP1	.270	.290	6.86	7.37
Q	.240	.256	6.10	6.50
Q1	.330	.346	8.38	8.79
øR	.155	.187	3.94	4.75
øR1	.085	.093	2.16	2.36
S	.243	.253	6.17	6.43

**PLUS247™ Outline**

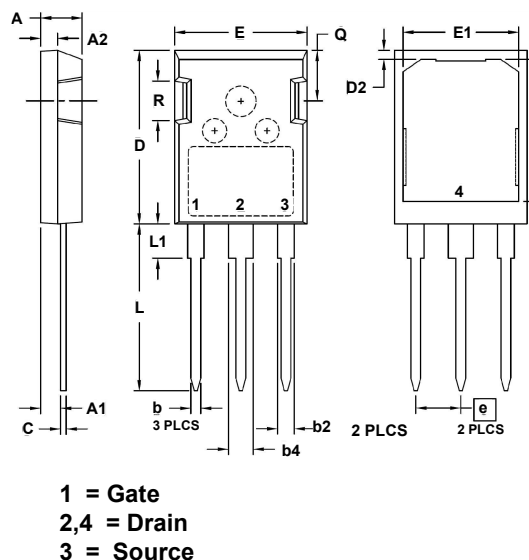

SYM	INCHES		MILLIMETERS	
	MIN	MAX	MIN	MAX
A	.190	.205	4.83	5.21
A1	.090	.100	2.29	2.54
A2	.075	.085	1.91	2.16
b	.045	.055	1.14	1.40
b2	.075	.087	1.91	2.20
b4	.115	.126	2.92	3.20
C	.024	.031	0.61	0.80
D	.819	.840	20.80	21.34
D1	.650	.690	16.51	17.53
D2	.035	.050	0.89	1.27
E	.620	.635	15.75	16.13
E1	.520	.560	13.08	14.22
e	.215 BSC		5.45 BSC	
L	.780	.810	19.81	20.57
L1	.150	.170	3.81	4.32
Q	.220	.244	5.59	6.20
R	.170	.190	4.32	4.83



---

Disclaimer Notice - Information furnished is believed to be accurate and reliable. However, users should independently evaluate the suitability of and test each product selected for their own applications. Littelfuse products are not designed for, and may not be used in, all applications. Read complete Disclaimer Notice at [www.littelfuse.com/disclaimer-electronics](http://www.littelfuse.com/disclaimer-electronics).

---