

HiPerFET™

Power MOSFETs ISOPLUS247™, Q-Class

IXFR 44N50Q

IXFR 48N50Q

V_{DSS}	I_{D25}	$R_{DS(on)}$
500 V	34 A	120 mΩ
500 V	40 A	110 mΩ

(Electrically Isolated Backside)

N-Channel Enhancement Mode
Avalanche Rated, Low Q_g , High dv/dt

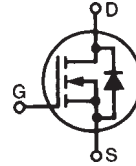

$t_{rr} \leq 250$ ns

Symbol	Test Conditions	Maximum Ratings	
V_{DSS}	$T_J = 25^\circ\text{C}$ to 150°C	500	V
V_{DGR}	$T_J = 25^\circ\text{C}$ to 150°C ; $R_{GS} = 1$ MΩ	500	V
V_{GS}	Continuous	±20	V
V_{GSM}	Transient	±30	V
I_{D25}	$T_C = 25^\circ\text{C}$	44N50Q 34 48N50Q 40	A
I_{DM}	$T_C = 25^\circ\text{C}$, Note 1	44N50Q 176 48N50Q 192	A
I_{AR}	$T_C = 25^\circ\text{C}$	44N50Q 44 48N50Q 48	A
E_{AR}	$T_C = 25^\circ\text{C}$	60	mJ
E_{AS}	$T_C = 25^\circ\text{C}$	2.5	J
dv/dt	$I_S \leq I_{DM}$, $di/dt \leq 100$ A/μs, $V_{DD} \leq V_{DSS}$ $T_J \leq 150^\circ\text{C}$, $R_G = 2$ Ω	15	V/ns
P_D	$T_C = 25^\circ\text{C}$	310	W
T_J		-55 ... +150	°C
T_{JM}		150	°C
T_{stg}		-55 ... +150	°C
T_L	1.6 mm (0.063 in.) from case for 10 s	300	°C
V_{ISOL}	50/60 Hz, RMS $t = 1$ min	2500	V~
Weight		5	g

ISOPLUS247™
E153432

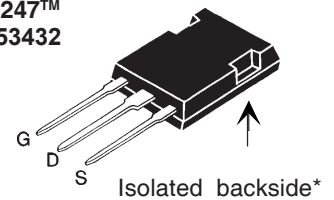

G = Gate D = Drain
S = Source

* Patent pending

Features

- Silicon chip on Direct-Copper-Bond substrate
 - High power dissipation
 - Isolated mounting surface
 - 2500V electrical isolation
- Low drain to tab capacitance (<30pF)
- IXYS advanced low Q_g process
- Rugged polysilicon gate cell structure
- Rated for Unclamped Inductive Load Switching (UIS)
- Fast intrinsic diode

Applications

- DC-DC converters
- Battery chargers
- Switched-mode and resonant-mode power supplies
- DC choppers
- AC motor control

Advantages

- Easy assembly
- Space savings
- High power density

Symbol	Test Conditions	Characteristic Values ($T_J = 25^\circ\text{C}$, unless otherwise specified)		
		min.	typ.	max.
V_{DSS}	$V_{GS} = 0$ V, $I_D = 250$ μA	500		V
$V_{GS(th)}$	$V_{DS} = V_{GS}$, $I_D = 4$ mA	2.0		4.0 V
I_{GSS}	$V_{GS} = \pm 20$ V, $V_{DS} = 0$			±100 nA
I_{DSS}	$V_{DS} = V_{DSS}$ $V_{GS} = 0$ V			100 μA 2 mA
$R_{DS(on)}$	$V_{GS} = 10$ V, $I_D = I_T$ Notes 2, 3	44N50Q 48N50Q		120 mΩ 110 mΩ

Symbol	Test Conditions	Notes	Characteristic Values ($T_J = 25^\circ\text{C}$, unless otherwise specified)		
			min.	typ.	max.
g_{fs}	$V_{DS} = 10\text{ V}; I_D = I_T$	Notes 2, 3	30	42	S
C_{iss}	$V_{GS} = 0\text{ V}, V_{DS} = 25\text{ V}, f = 1\text{ MHz}$			7000	pF
C_{oss}				960	pF
C_{rss}				230	pF
$t_{d(on)}$	$V_{GS} = 10\text{ V}, V_{DS} = 0.5 \cdot V_{DSS}, I_D = I_T$ $R_G = 1\ \Omega$ (External), Notes 2, 3			33	ns
t_r				22	ns
$t_{d(off)}$				75	ns
t_f				10	ns
$Q_{g(on)}$	$V_{GS} = 10\text{ V}, V_{DS} = 0.5 \cdot V_{DSS}, I_D = I_T$ Notes 2, 3			190	nC
Q_{gs}				40	nC
Q_{gd}				86	nC
R_{thJC}				0.40	K/W
R_{thCK}				0.15	K/W

Source-Drain Diode

Symbol	Test Conditions	Characteristic Values ($T_J = 25^\circ\text{C}$, unless otherwise specified)		
		min.	typ.	max.
I_S	$V_{GS} = 0\text{ V}$			48 A
I_{SM}	Repetitive; Note 1			192 A
V_{SD}	$I_F = I_T, V_{GS} = 0\text{ V}$, Notes 2, 3			1.5 V
t_{rr}	$I_F = 25\text{ A}, -di/dt = 100\text{ A}/\mu\text{s}, V_R = 100\text{ V}$			250 ns
Q_{RM}				1.0 μC
I_{RM}				10 A

- Note: 1. Pulse width limited by T_{JM}
 2. Pulse test, $t \leq 300\ \mu\text{s}$, duty cycle $d \leq 2\%$
 3. IXFR44N50Q: $I_T = 22\text{ A}$
 IXFR48N50Q: $I_T = 24\text{ A}$

ISOPLUS 247 OUTLINE

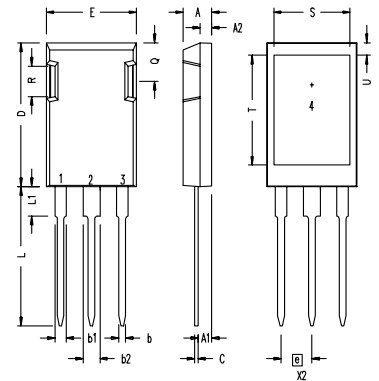

- 1 Gate, 2 Drain (Collector)
 3 Source (Emitter)
 4 no connection

Dim.	Millimeter		Inches	
	Min.	Max.	Min.	Max.
A	4.83	5.21	.190	.205
A ₁	2.29	2.54	.090	.100
A ₂	1.91	2.16	.075	.085
b	1.14	1.40	.045	.055
b ₁	1.91	2.13	.075	.084
b ₂	2.92	3.12	.115	.123
C	0.61	0.80	.024	.031
D	20.80	21.34	.819	.840
E	15.75	16.13	.620	.635
e	5.45 BSC		.215 BSC	
L	19.81	20.32	.780	.800
L1	3.81	4.32	.150	.170
Q	5.59	6.20	.220	.244
R	4.32	4.83	.170	.190

**Fig. 1. Output Characteristics
@ 25 Deg. C**

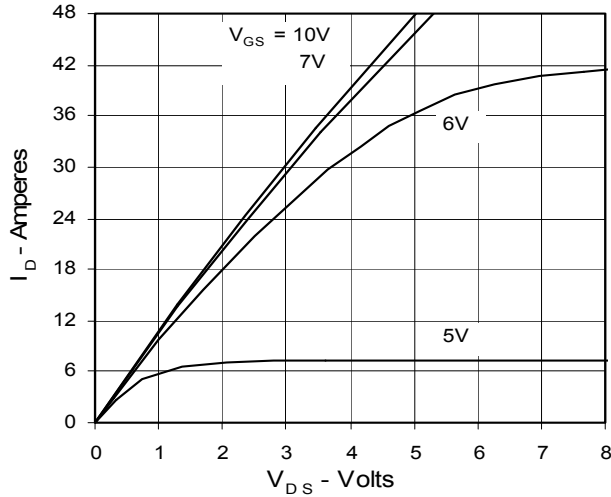

**Fig. 2. Extended Output Characteristics
@ 25 deg. C**

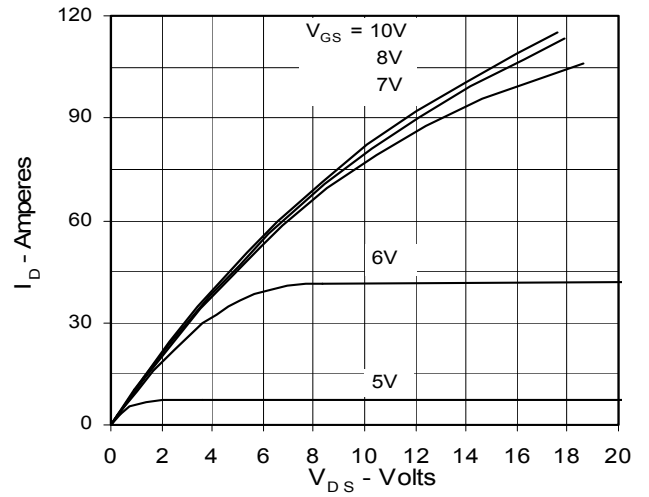

**Fig. 3. Output Characteristics
@ 125 Deg. C**

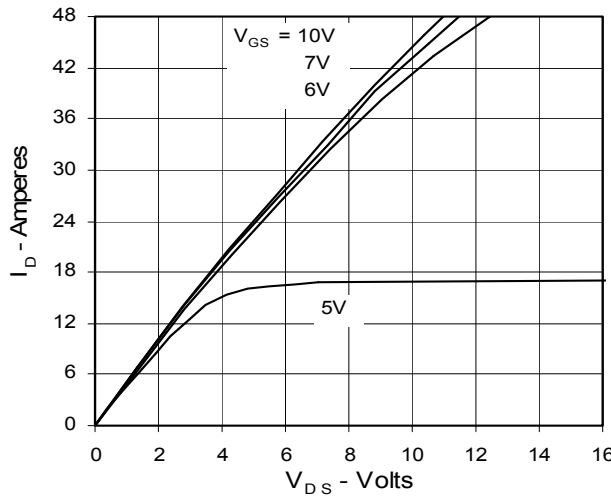

**Fig. 4. $R_{DS(on)}$ Normalized to I_{D25} Value vs.
Junction Temperature**

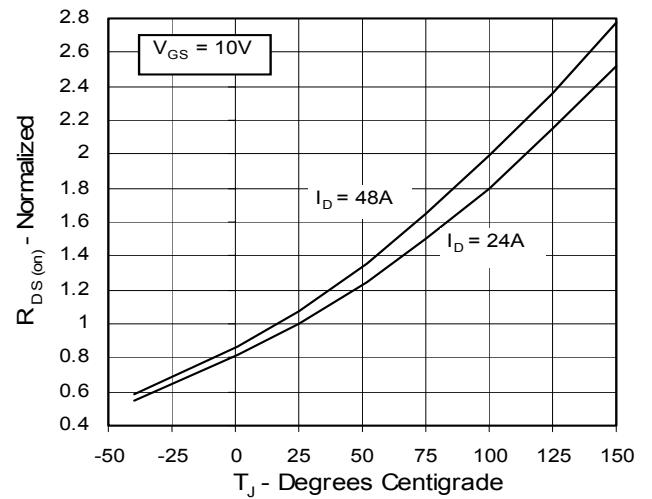

**Fig. 5. $R_{DS(on)}$ Normalized to I_{D25}
Value vs. I_D**

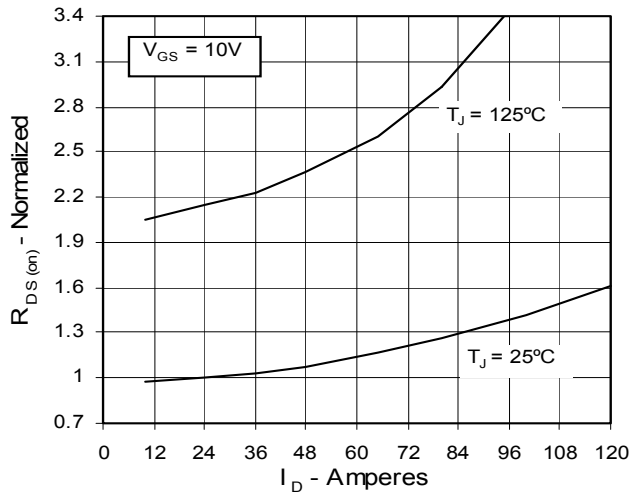

**Fig. 6. Drain Current vs. Case
Temperature**

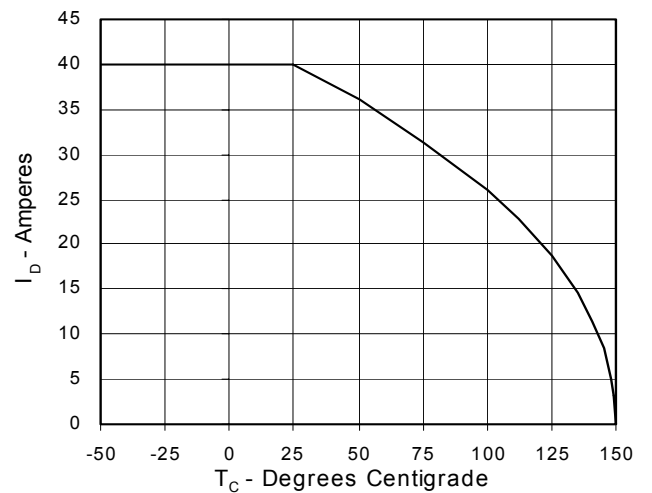

Fig. 7. Input Admittance

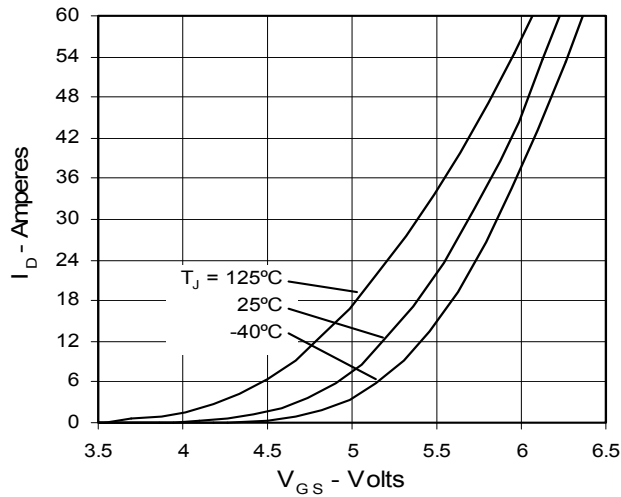

Fig. 8. Transconductance

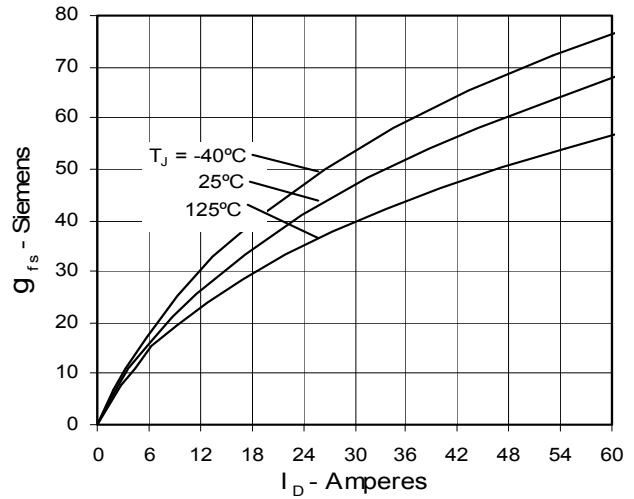

Fig. 9. Source Current vs. Source-To-Drain Voltage

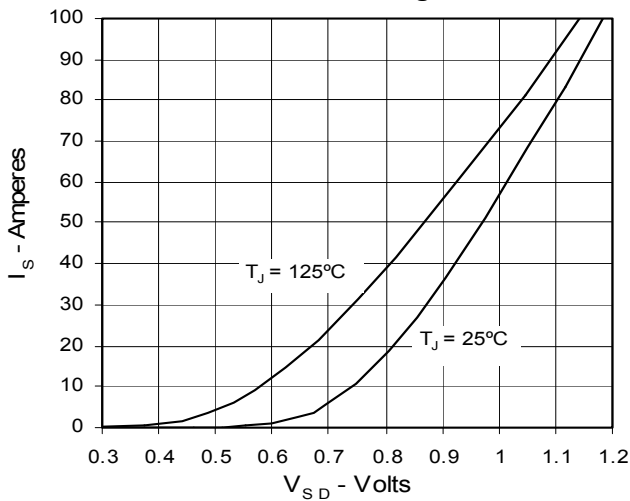

Fig. 10. Gate Charge

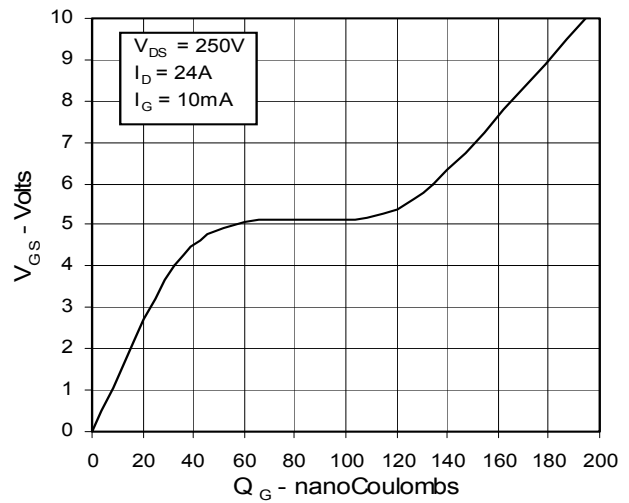

Fig. 11. Capacitance

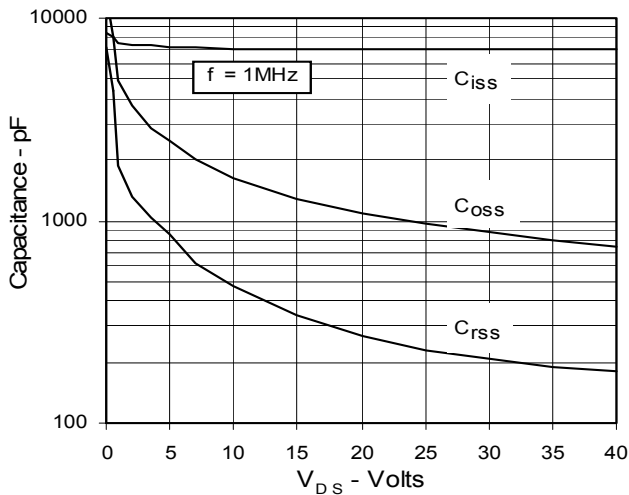
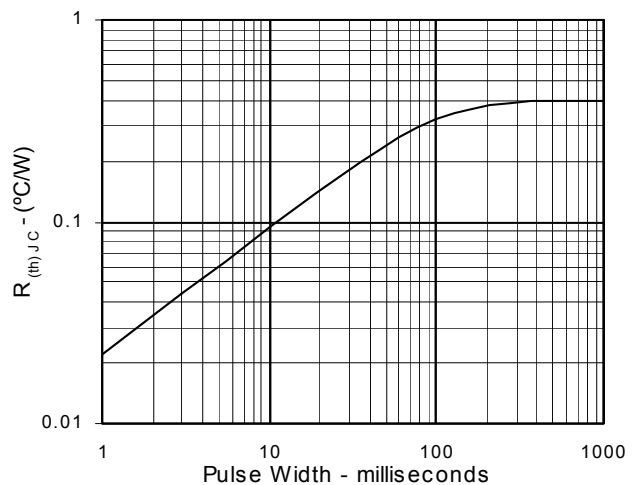

Fig. 12. Maximum Transient Thermal Resistance



IXYS reserves the right to change limits, test conditions, and dimensions.

IXYS MOSFETs and IGBTs are covered by one or more of the following U.S. patents:

4,835,592 4,881,106 5,017,508 5,049,961 5,187,117 5,486,715 6,306,728B1 6,259,123B1 6,306,728B1
4,850,072 4,931,844 5,034,796 5,063,307 5,237,481 5,381,025 6,404,065B1 6,162,665 6,534,343



Disclaimer Notice - Information furnished is believed to be accurate and reliable. However, users should independently evaluate the suitability of and test each product selected for their own applications. Littelfuse products are not designed for, and may not be used in, all applications. Read complete Disclaimer Notice at www.littelfuse.com/disclaimer-electronics.