

PolarHV™ HiPerFET IXFR 24N80P

Power MOSFET

(Electrically Isolated Back Surface)

N-Channel Enhancement Mode
Avalanche Rated
Fast Intrinsic Diode

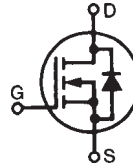

V_{DSS}	=	800	V
I_{D25}	=	13	A
$R_{DS(on)}$	≤	420	mΩ
t_{rr}	≤	200	ns

Symbol	Test Conditions	Maximum Ratings	
V_{DSS}	$T_J = 25^\circ\text{C}$ to 150°C	800	V
V_{DGR}	$T_J = 25^\circ\text{C}$ to 150°C ; $R_{GS} = 1\text{ M}\Omega$	800	V
V_{GSS}	Continuous	±30	V
V_{GSM}	Transient	±40	V
I_{D25}	$T_C = 25^\circ\text{C}$	13	A
I_{DM}	$T_C = 25^\circ\text{C}$, pulse width limited by T_{JM}	55	A
I_{AR}	$T_C = 25^\circ\text{C}$	12	A
E_{AR}	$T_C = 25^\circ\text{C}$	50	mJ
E_{AS}	$T_C = 25^\circ\text{C}$	1.5	J
dv/dt	$I_S \leq I_{DM}$, $di/dt \leq 100\text{ A}/\mu\text{s}$, $V_{DD} \leq V_{DSS}$, $T_J \leq 150^\circ\text{C}$, $R_G = 2\ \Omega$	10	V/ns
P_D	$T_C = 25^\circ\text{C}$	208	W
T_J		-55 ... +150	°C
T_{JM}		150	°C
T_{stg}		-55 ... +150	°C
T_L	1.6 mm (0.062 in.) from case for 10 s	300	°C
T_{SOLD}	Plastic body for 10 s	260	°C
V_{ISOL}	50/60 Hz, RMS, 1 minute	2500	V~
F_C	Mounting force	20..120/4.6..27	N/lb
Weight		5	g

ISOPLUS247 (IXFR)
E153432

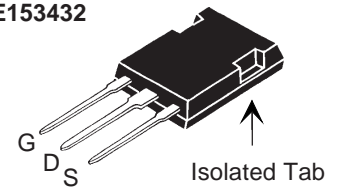

G = Gate D = Drain
S = Source

Features

- Silicon chip on Direct-Copper-Bond substrate
 - High power dissipation
 - Isolated mounting surface
 - 2500V electrical isolation
- International standard package
- Fast recovery diode
- Unclamped Inductive Switching (UIS) rated
- Low package inductance
 - easy to drive and to protect

Advantages

- Easy to mount
- Space savings
- High power density

Symbol	Test Conditions	Characteristic Values		
		Min.	Typ.	Max.
BV_{DSS}	$V_{GS} = 0\text{ V}$, $I_D = 250\ \mu\text{A}$	800		V
$V_{GS(th)}$	$V_{DS} = V_{GS}$, $I_D = 4\text{ mA}$	3.0		5.0 V
I_{GSS}	$V_{GS} = \pm 30\text{ V}$, $V_{DS} = 0\text{ V}$			±100 nA
I_{DSS}	$V_{DS} = V_{DSS}$ $V_{GS} = 0\text{ V}$ $T_J = 125^\circ\text{C}$			25 μA 1000 μA
$R_{DS(on)}$	$V_{GS} = 10\text{ V}$, $I_D = I_T$ (note 1) Pulse test, $t \leq 300\ \mu\text{s}$, duty cycle $d \leq 2\%$			420 mΩ

Symbol	Test Conditions	Characteristic Values ($T_J = 25^\circ\text{C}$, unless otherwise specified)		
		Min.	Typ.	Max.
g_{fs}	$V_{DS} = 20\text{ V}$; $I_D = I_T$, pulse test	15	25	S
C_{iss}	$V_{GS} = 0\text{ V}$, $V_{DS} = 25\text{ V}$, $f = 1\text{ MHz}$		7200	pF
C_{oss}			470	pF
C_{rss}			26	pF
$t_{d(on)}$	$V_{GS} = 10\text{ V}$, $V_{DS} = 0.5 V_{DSS}$, $I_D = I_T$ $R_G = 2\ \Omega$ (External)		32	ns
t_r			27	ns
$t_{d(off)}$			75	ns
t_f			24	ns
$Q_{g(on)}$	$V_{GS} = 10\text{ V}$, $V_{DS} = 0.5 V_{DSS}$, $I_D = I_T$		105	nC
Q_{gs}			30	nC
Q_{gd}			33	nC
R_{thJC}			0.6	$^\circ\text{C/W}$
R_{thCS}		0.15		$^\circ\text{C/W}$

Note 1: Test current $I_T = 12\text{ A}$

Source-Drain Diode

Symbol	Test Conditions	Characteristic Values ($T_J = 25^\circ\text{C}$, unless otherwise specified)		
		Min.	Typ.	Max.
I_S	$V_{GS} = 0\text{ V}$			24 A
I_{SM}	Repetitive			55 A
V_{SD}	$I_F = I_S$, $V_{GS} = 0\text{ V}$, Pulse test, $t \leq 300\ \mu\text{s}$, duty cycle $d \leq 2\%$			1.5 V
t_{rr}	$I_F = 25\text{ A}$, $-di/dt = 100\text{ A}/\mu\text{s}$ $V_R = 100\text{ V}$, $V_{GS} = 0\text{ V}$			250 ns
Q_{RM}			0.8	μC
I_{RM}			6.0	A

ISOPLUS247 (IXFR) Outline

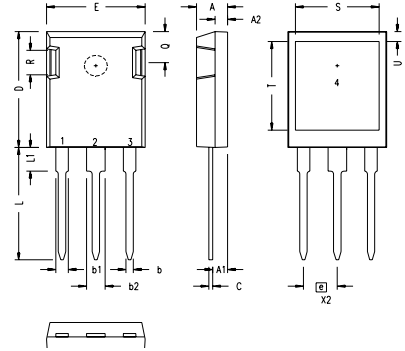

SYM	INCHES		MILLIMETERS	
	MIN	MAX	MIN	MAX
A	.190	.205	4.83	5.21
A1	.090	.100	2.29	2.54
A2	.075	.085	1.91	2.16
b	.045	.055	1.14	1.40
b1	.075	.084	1.91	2.13
b2	.115	.123	2.92	3.12
C	.024	.031	0.61	0.80
D	.819	.840	20.80	21.34
E	.620	.635	15.75	16.13
e	.215 BSC		5.45 BSC	
L	.780	.800	19.81	20.32
L1	.150	.170	3.81	4.32
Q	.220	.244	5.59	6.20
R	.170	.190	4.32	4.83
S	.520	.540	13.21	13.72
T	.620	.640	15.75	16.26
U	.065	.080	1.65	2.03

- 1 - GATE
- 2 - DRAIN (COLLECTOR)
- 3 - SOURCE (EMITTER)
- 4 - NO CONNECTION

NOTE: This drawing will meet all dimensions requirement of JEDEC outline TO-247AD except screw hole.

IXYS reserves the right to change limits, test conditions, and dimensions.

IXYS MOSFETs and IGBTs are covered by 4,835,592 4,931,844 5,049,961 5,237,481 6,162,665 6,404,065 B1 6,683,344 6,727,585 7,005,734 B2
 one or more of the following U.S. patents: 4,850,072 5,017,508 5,063,307 5,381,025 6,259,123 B1 6,534,343 6,710,405B2 6,759,692
 4,881,106 5,034,796 5,187,117 5,486,715 6,306,728 B1 6,583,505 6,710,463 6,771,478 B2

Fig. 1. Output Characteristics @ 25°C

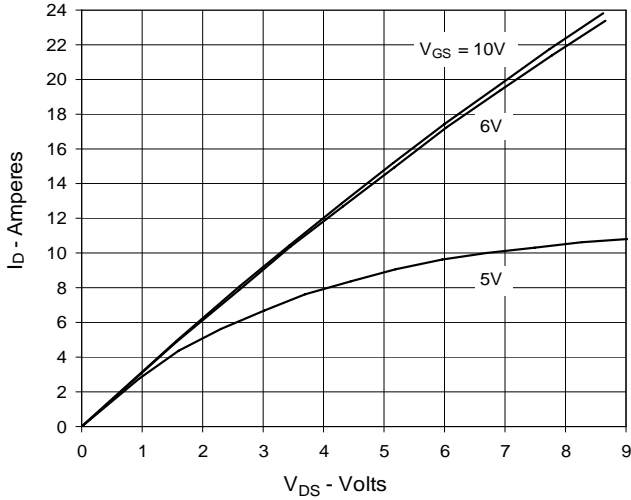

Fig. 2. Extended Output Characteristics @ 25°C

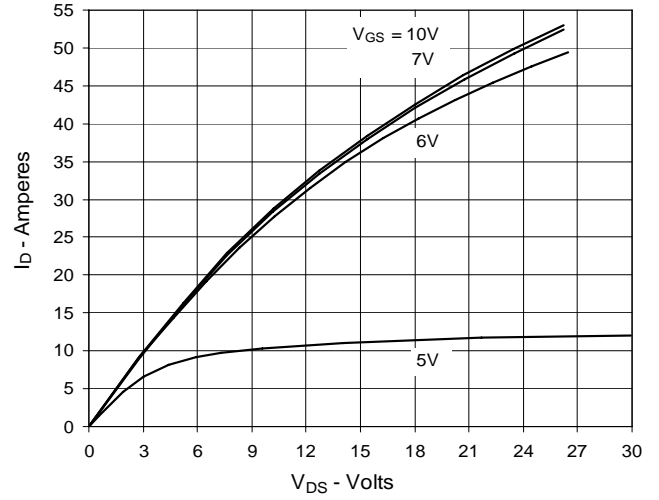

Fig. 3. Output Characteristics @ 125°C

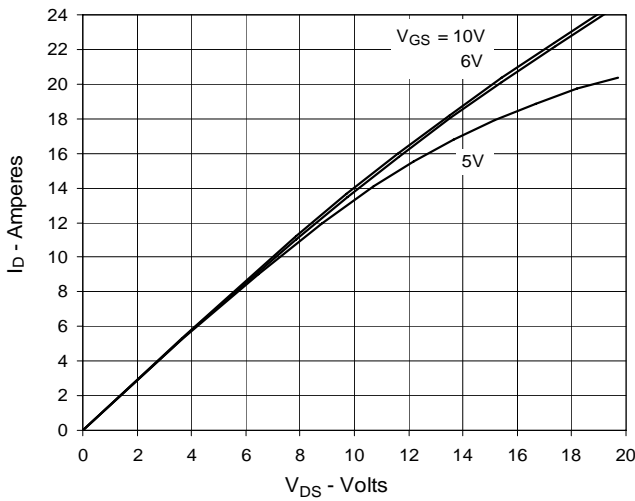

Fig. 4. $R_{DS(on)}$ Normalized to $I_D = 12A$ Value vs. Junction Temperature

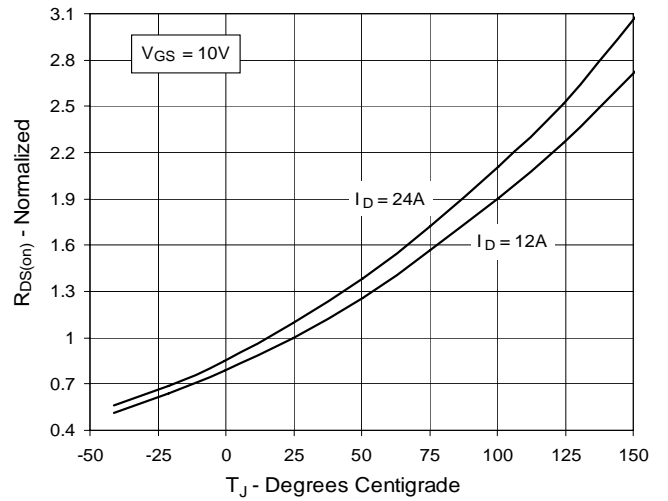

Fig. 5. $R_{DS(on)}$ Normalized to $I_D = 12A$ Value vs. Drain Current

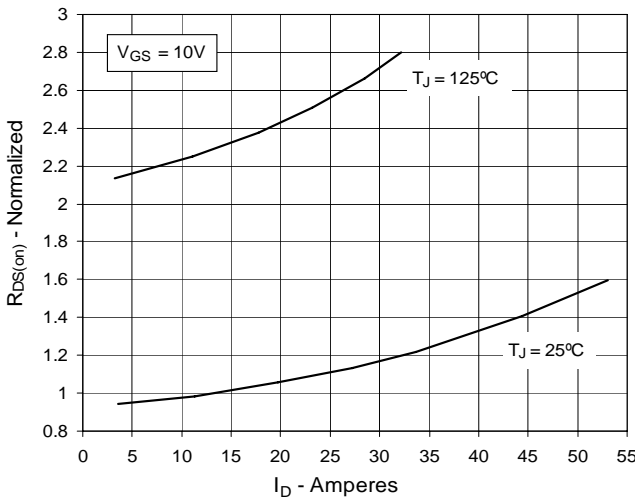

Fig. 6. Maximum Drain Current vs. Case Temperature

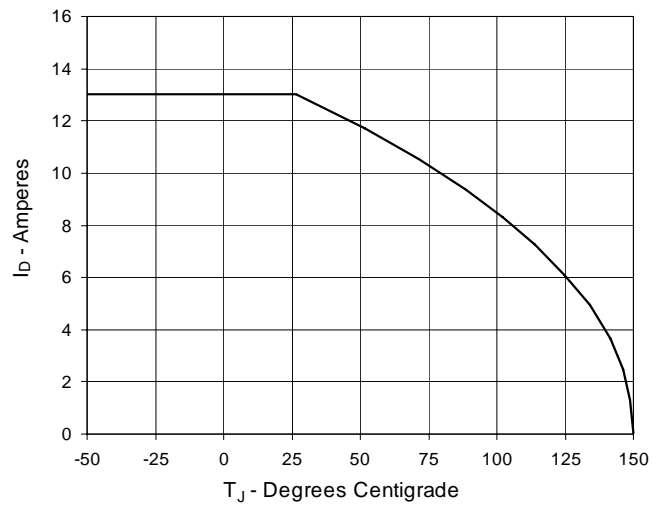

Fig. 7. Input Admittance

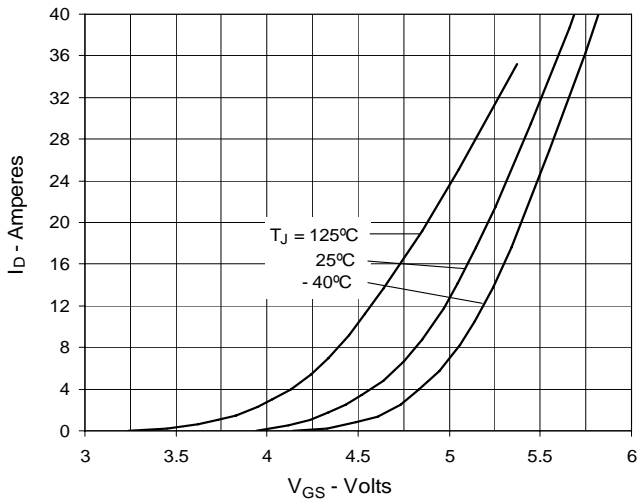

Fig. 8. Transconductance

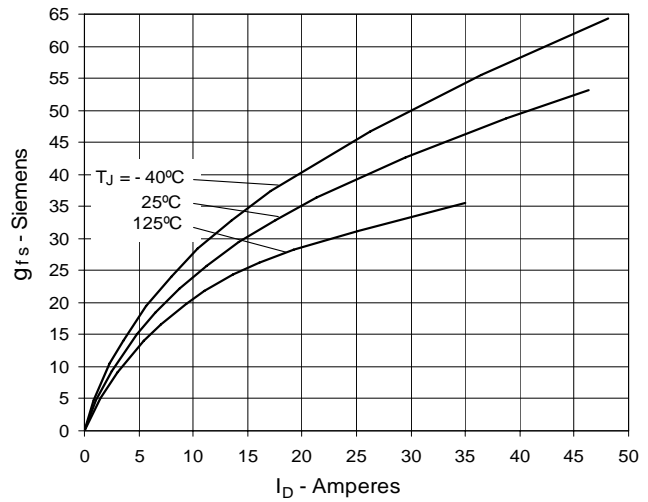

Fig. 9. Forward Voltage Drop of Intrinsic Diode

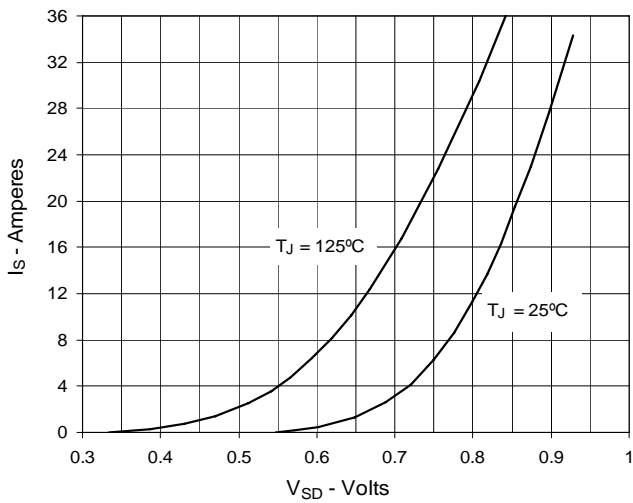

Fig. 10. Gate Charge

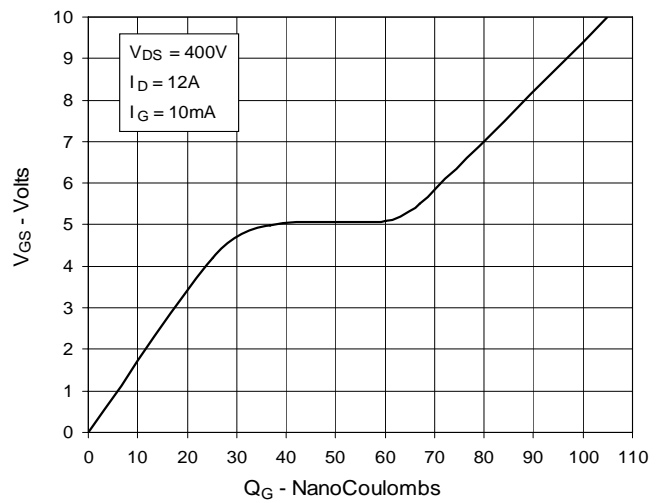

Fig. 11. Capacitance

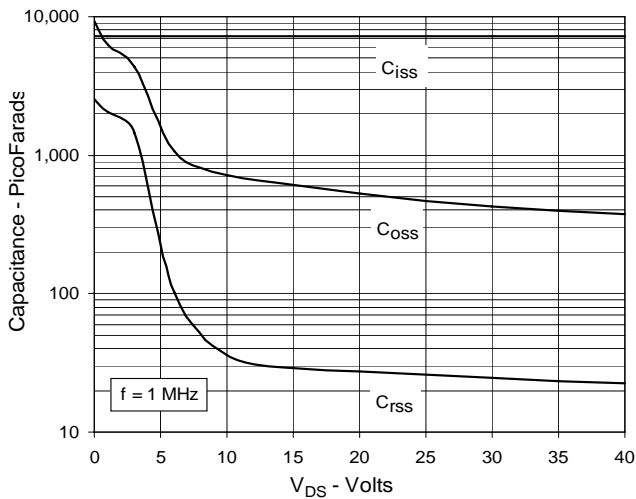
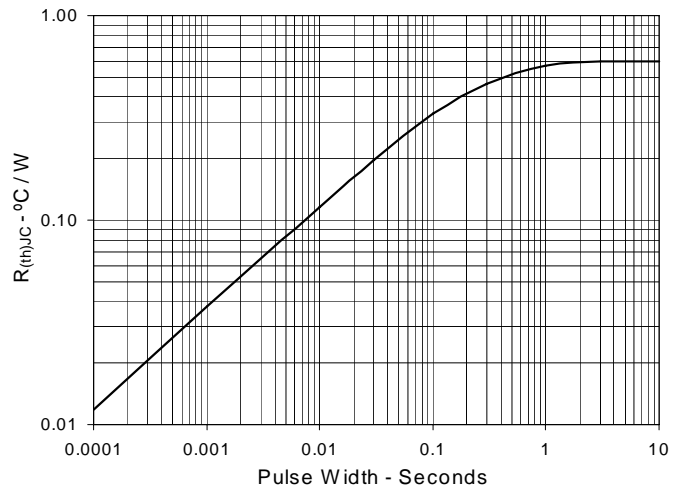

Fig. 12. Maximum Transient Thermal Resistance





Disclaimer Notice - Information furnished is believed to be accurate and reliable. However, users should independently evaluate the suitability of and test each product selected for their own applications. Littelfuse products are not designed for, and may not be used in, all applications. Read complete Disclaimer Notice at www.littelfuse.com/disclaimer-electronics.