

# Polar™ Power MOSFET IXFP12N50PM

## HiPerFET™

(Electrically Isolated Tab)

N-Channel Enhancement Mode  
Avalanche Rated  
Fast Intrinsic Diode

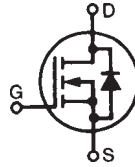

$$V_{DSS} = 500V$$

$$I_{D25} = 6A$$

$$R_{DS(on)} \leq 500m\Omega$$

$$t_{rr} \leq 300ns$$

OVERMOLDED TO-220  
(IXFP...M) OUTLINE

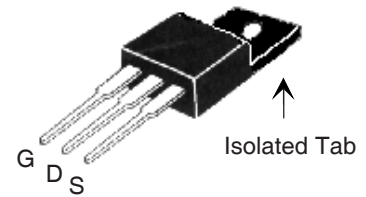

G = Gate      D = Drain  
S = Source

Symbol	Test Conditions	Maximum Ratings	
$V_{DSS}$	$T_J = 25^\circ C$ to $150^\circ C$	500	V
$V_{DGR}$	$T_J = 25^\circ C$ to $150^\circ C$ ; $R_{GS} = 1 M\Omega$	500	V
$V_{GSS}$	Continuous	$\pm 30$	V
$V_{GSM}$	Transient	$\pm 40$	V
$I_{D25}$	$T_C = 25^\circ C$	6	A
$I_{DM}$	$T_C = 25^\circ C$ , pulse width limited by $T_{JM}$	30	A
$I_A$	$T_C = 25^\circ C$	12	A
$E_{AS}$	$T_C = 25^\circ C$	600	mJ
$dv/dt$	$I_S \leq I_{DM}$ , $V_{DD} \leq V_{DSS}$ , $T_J = 150^\circ C$	10	V/ns
$P_D$	$T_C = 25^\circ C$	50	W
$T_J$		- 55 ... +150	$^\circ C$
$T_{JM}$		150	$^\circ C$
$T_{stg}$		- 55 ... +150	$^\circ C$
$T_L$	1.6 mm (0.062 in.) from case for 10 s	300	$^\circ C$
$T_{SOLD}$	Plastic body for 10 s	260	$^\circ C$
$M_d$	Mounting torque	1.13/10	Nm/lb.in.
<b>Weight</b>		2.5	g

### Features

- Plastic overmolded tab for electrical isolation
- International standard package
- Unclamped Inductive Switching (UIS) rated
- Low package inductance
  - easy to drive and to protect

### Advantages

- Easy to mount
- Space savings

Symbol	Test Conditions ( $T_J = 25^\circ C$ , unless otherwise specified)	Characteristic Values		
		Min.	Typ.	Max.
$BV_{DSS}$	$V_{GS} = 0V$ , $I_D = 250\mu A$	500		V
$V_{GS(th)}$	$V_{DS} = V_{GS}$ , $I_D = 1mA$	3.0		5.5 V
$I_{GSS}$	$V_{GS} = \pm 30V$ , $V_{DS} = 0V$			$\pm 100$ nA
$I_{DSS}$	$V_{DS} = V_{DSS}$ $V_{GS} = 0V$ $T_J = 125^\circ C$			5 $\mu A$ 250 $\mu A$
$R_{DS(on)}$	$V_{GS} = 10V$ , $I_D = 6A$ , Note 1			500 m $\Omega$

Symbol	Test Conditions	Characteristic Values ( $T_J = 25^\circ\text{C}$ , unless otherwise specified)		
		Min.	Typ.	Max.
$g_{fs}$	$V_{DS} = 10\text{V}, I_D = 6\text{A}$ , Note 1	7.5	13	S
$C_{iss}$	$V_{GS} = 0\text{V}, V_{DS} = 25\text{V}, f = 1\text{MHz}$		1830	pF
$C_{oss}$			182	pF
$C_{rss}$			16	pF
$t_{d(on)}$	$V_{GS} = 10\text{V}, V_{DS} = 0.5 \cdot V_{DSS}, I_D = 6\text{A}$ $R_G = 10\Omega$ (External)		22	ns
$t_r$			27	ns
$t_{d(off)}$			65	ns
$t_f$			20	ns
$Q_{g(on)}$	$V_{GS} = 10\text{V}, V_{DS} = 0.5 \cdot V_{DSS}, I_D = 6\text{A}$		29	nC
$Q_{gs}$			11	nC
$Q_{gd}$			10	nC
$R_{thJC}$				2.5 $^\circ\text{C/W}$

### Source-Drain Diode

Symbol	Test Conditions	Characteristic Values ( $T_J = 25^\circ\text{C}$ unless otherwise specified)		
		Min.	Typ.	Max.
$I_S$	$V_{GS} = 0\text{V}$			12 A
$I_{SM}$	Repetitive, pulse width limited by $T_{JM}$			48 A
$V_{SD}$	$I_F = I_S, V_{GS} = 0\text{V}$ , Note 1			1.5 V
$t_{rr}$	$I_F = 6\text{A}, -di/dt = 150\text{A}/\mu\text{s}$ $V_R = 100\text{V}, V_{GS} = 0\text{V}$			300 ns
$Q_{RM}$			2.8	$\mu\text{C}$
$I_{RM}$			18.2	A

### ISOLATED TO-220 (IXFP...M)

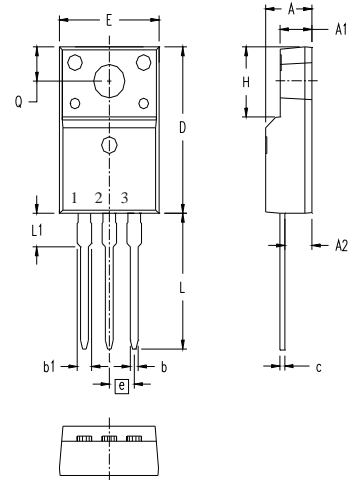

Terminals: 1 - Gate  
2 - Drain (Collector)  
3 - Source (Emitter)

SYM	INCHES		MILLIMETERS	
	MIN	MAX	MIN	MAX
A	.177	.193	4.50	4.90
A1	.092	.108	2.34	2.74
A2	.101	.117	2.56	2.96
b	.028	.035	0.70	0.90
b1	.050	.058	1.27	1.47
c	.018	.024	0.45	0.60
D	.617	.633	15.67	16.07
E	.392	.408	9.96	10.36
e	.100 BSC		2.54 BSC	
H	.255	.271	6.48	6.88
L	.499	.523	12.68	13.28
L1	.119	.135	3.03	3.43
$\varnothing P$	.121	.129	3.08	3.28
Q	.126	.134	3.20	3.40

Notes: 1. Pulse test,  $t \leq 300 \mu\text{s}$ ; duty cycle,  $d \leq 2\%$ .

IXYS reserves the right to change limits, test conditions, and dimensions.

IXYS MOSFETs and IGBTs are covered by one or more of the following U.S. patents:

4,835,592	4,931,844	5,049,961	5,237,481	6,162,665	6,404,065 B1	6,683,344	6,727,585	7,005,734 B2	7,157,338 B2
4,850,072	5,017,508	5,063,307	5,381,025	6,259,123 B1	6,534,343	6,710,405 B2	6,759,692	7,063,975 B2	
4,881,106	5,034,796	5,187,117	5,486,715	6,306,728 B1	6,583,505	6,710,463	6,771,478 B2	7,071,537	

**Fig. 1. Output Characteristics**  
@ 25°C

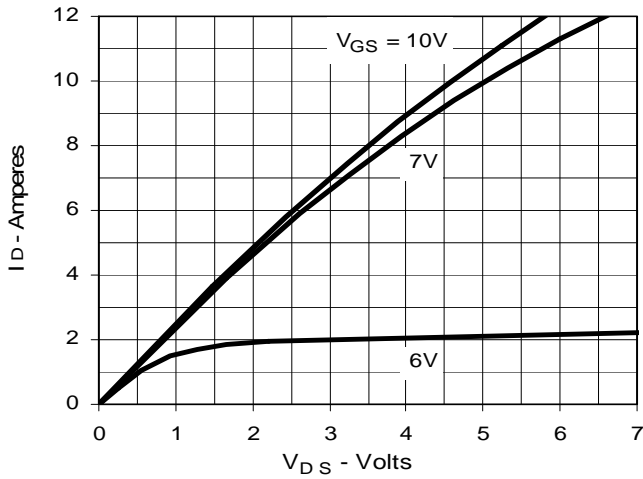

**Fig. 2. Extended Output Characteristics**  
@ 25°C

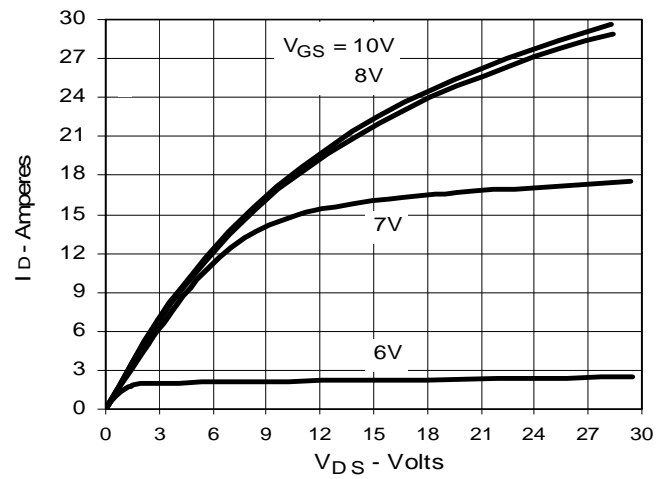

**Fig. 3. Output Characteristics**  
@ 125°C

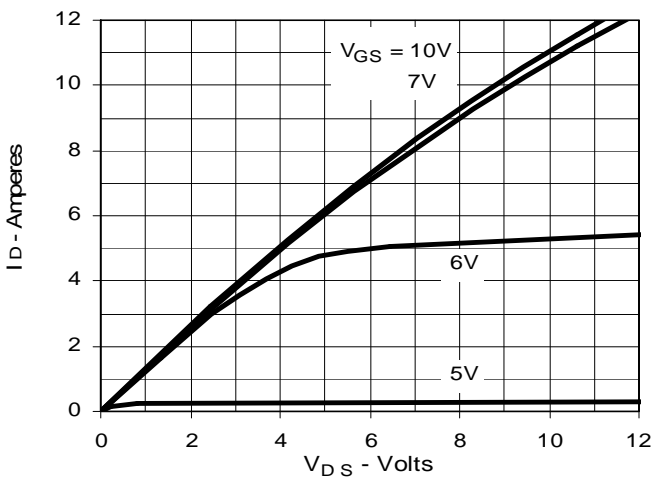

**Fig. 4.  $R_{DS(on)}$  Normalized to  $I_D = 6A$  Value vs. Junction Temperature**

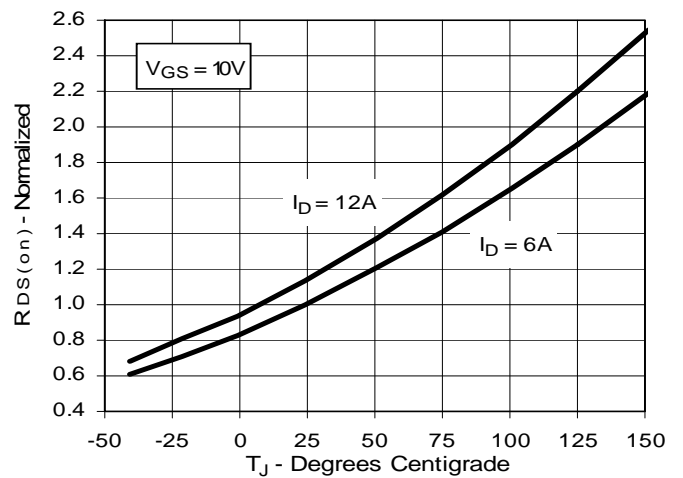

**Fig. 5.  $R_{DS(on)}$  Normalized to  $I_D = 6A$  Value vs. Drain Current**

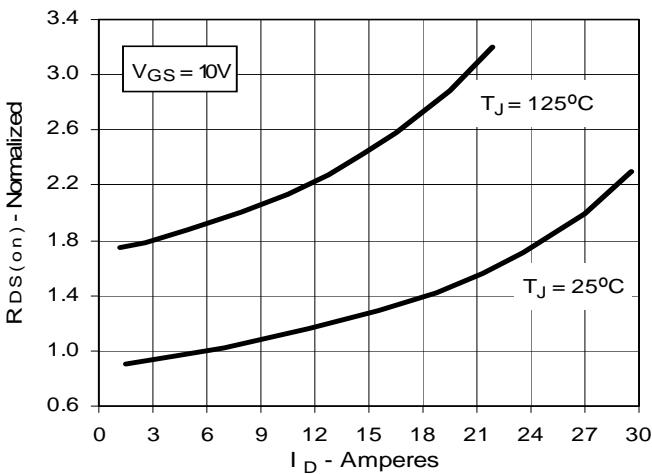

**Fig. 6. Drain Current vs. Case Temperature**

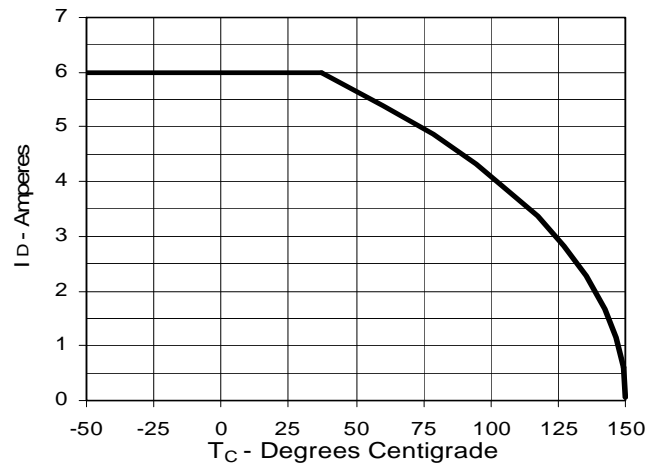

**Fig. 7. Input Admittance**

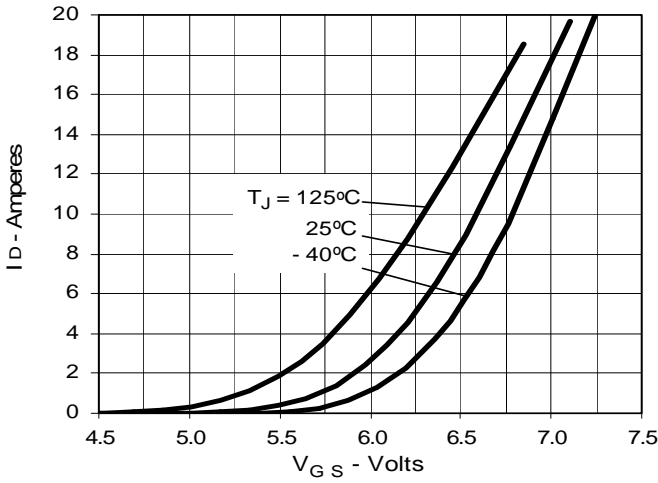

**Fig. 8. Transconductance**

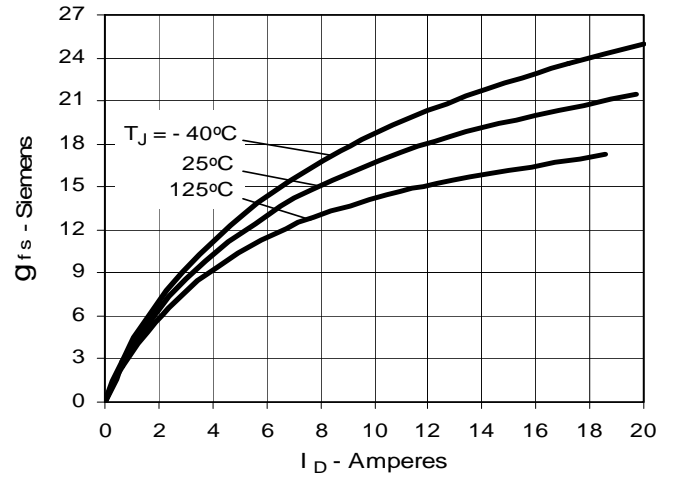

**Fig. 9. Source Current vs. Source-To-Drain Voltage**

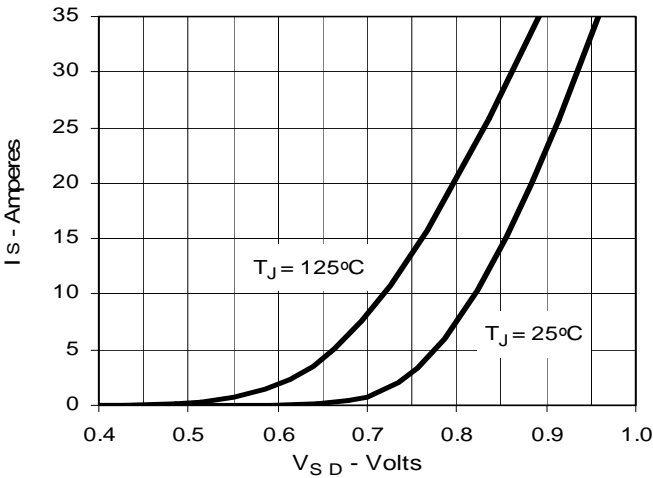

**Fig. 10. Gate Charge**

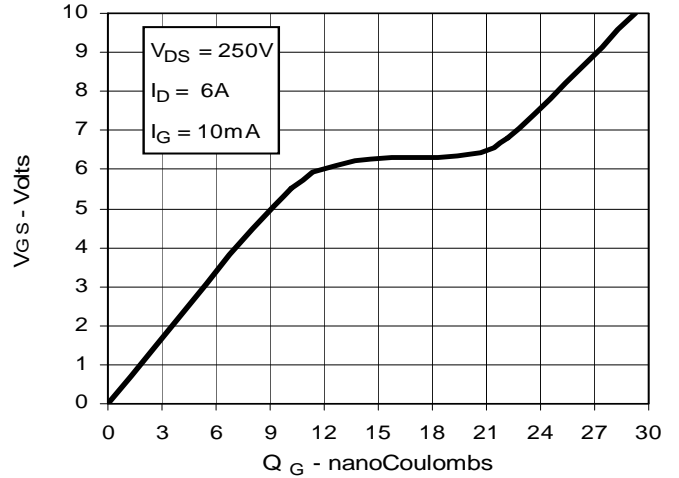

**Fig. 11. Capacitance**

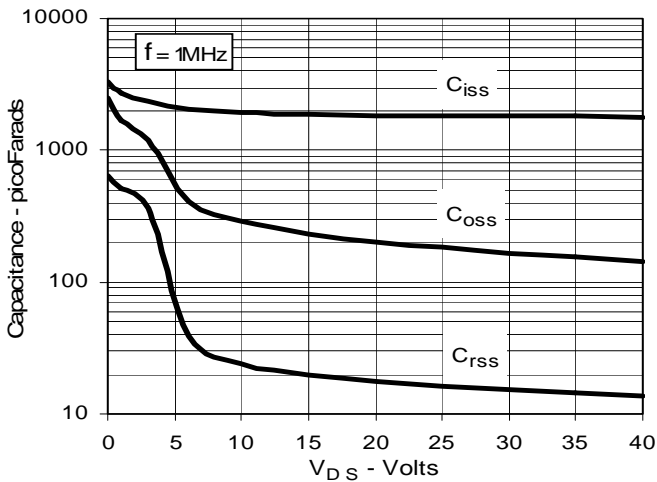

**Fig. 12. Forward-Bias Safe Operating Area**

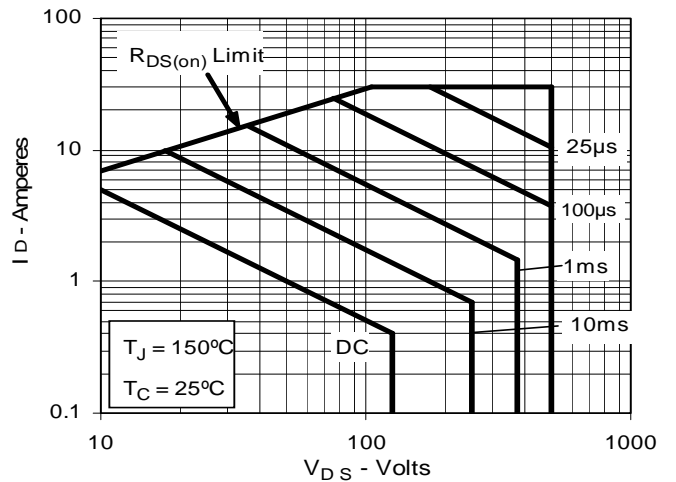
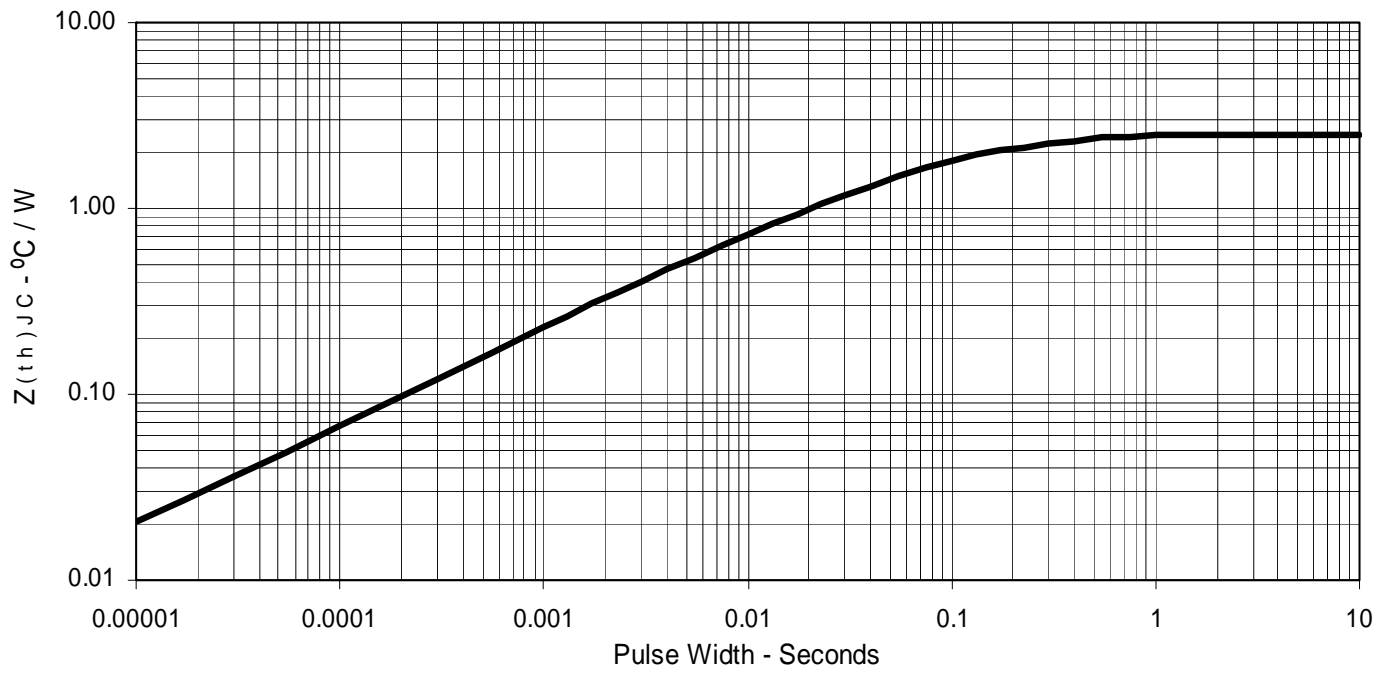

Fig. 13. Maximum Transient Thermal Impedance





---

Disclaimer Notice - Information furnished is believed to be accurate and reliable. However, users should independently evaluate the suitability of and test each product selected for their own applications. Littelfuse products are not designed for, and may not be used in, all applications. Read complete Disclaimer Notice at [www.littelfuse.com/disclaimer-electronics](http://www.littelfuse.com/disclaimer-electronics).