

HiPerFET™ Power MOSFETs Q-Class

IXFN 44N50Q
IXFN 48N50Q

N-Channel Enhancement Mode
Avalanche Rated, Low Q_g , High dv/dt

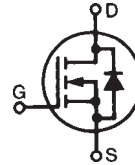

V_{DSS}	I_{D25}	$R_{DS(on)}$
500 V	44 A	120 mΩ
500 V	48 A	100 mΩ

$t_{rr} \leq 250$ ns

miniBLOC, SOT-227 B (IXFN)
E153432

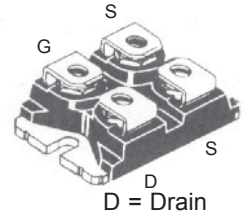

G = Gate
S = Source

Either Source terminal at miniBLOC can be used as Main or Kelvin Source

Features

- IXYS advanced low Q_g process
- Low gate charge and capacitances
- easier to drive
- faster switching
- Unclamped Inductive Switching (UIS) rated
- Low $R_{DS(on)}$
- Fast intrinsic diode
- International standard package
- miniBLOC with Aluminium nitride isolation for low thermal resistance
- Low terminal inductance (<10 nH) and stray capacitance to heatsink (<35pf)
- Molding epoxies meet UL 94 V-0 flammability classification

Applications

- DC-DC converters
- Battery chargers
- Switched-mode and resonant-mode power supplies
- DC choppers
- Temperature and lighting controls

Advantages

- Easy to mount
- Space savings
- High power density

Symbol	Test Conditions	Maximum Ratings	
V_{DSS}	$T_J = 25^\circ\text{C}$ to 150°C	500	V
V_{DGR}	$T_J = 25^\circ\text{C}$ to 150°C ; $R_{GS} = 1$ MΩ	500	V
V_{GS}	Continuous	±20	V
V_{GSM}	Transient	±30	V
I_{D25}	$T_C = 25^\circ\text{C}$	44N50 48N50	44 48
I_{DM}	$T_C = 25^\circ\text{C}$, pulse width limited by T_{JM}	44N50 48N50	176 192
I_{AR}	$T_C = 25^\circ\text{C}$	48	A
E_{AR} E_{AS}	$T_C = 25^\circ\text{C}$	60	mJ
		2.5	mJ
dv/dt	$I_S \leq I_{DM}$, $di/dt \leq 100$ A/μs, $V_{DD} \leq V_{DSS}$, $T_J \leq 150^\circ\text{C}$, $R_G = 2$ Ω	15	V/ns
P_D	$T_C = 25^\circ\text{C}$	500	W
T_J		-55 to +150	°C
T_{JM}		150	°C
T_{stg}		-55 to +150	°C
V_{ISOL}	50/60 Hz, RMS $t = 1$ min $I_{ISOL} \leq 1$ mA $t = 1$ s	2500 3000	V~ V~
M_d	Mounting torque Terminal connection torque	1.5/13 1.5/13	Nm/lb.in. Nm/lb.in.
Weight		30	g

Symbol	Test Conditions	Characteristic Values ($T_J = 25^\circ\text{C}$, unless otherwise specified)		
		min.	typ.	max.
V_{DSS}	$V_{GS} = 0$ V, $I_D = 1$ mA	500		V
$V_{GS(th)}$	$V_{DS} = V_{GS}$, $I_D = 4$ mA	2.0		4.0 V
I_{GSS}	$V_{GS} = \pm 20$ V _{DC} , $V_{DS} = 0$			±100 nA
I_{DSS}	$V_{DS} = V_{DSS}$, $V_{GS} = 0$ V		$T_J = 25^\circ\text{C}$ $T_J = 125^\circ\text{C}$	100 μA 2 mA
$R_{DS(on)}$	$V_{GS} = 10$ V, $I_D = 0.5 I_{D25}$ Pulse test, $t \leq 300$ μs, duty cycle $d \leq 2\%$	44N50 48N50		120 Ω 100 Ω

Symbol	Test Conditions	Characteristic Values		
		(T _J = 25°C, unless otherwise specified)		
		min.	typ.	max.
g_{fs}	V _{DS} = 20 V; I _D = 0.5 • I _{D25} , pulse test	30	42	S
C_{iss}	V _{GS} = 0 V, V _{DS} = 25 V, f = 1 MHz		7000	pF
C_{oss}			960	pF
C_{rss}			230	pF
t_{d(on)}	V _{GS} = 10 V, V _{DS} = 0.5 • V _{DSS} , I _D = 0.5 • I _{D25} R _G = 4.7 Ω (External),		33	ns
t_r			22	ns
t_{d(off)}			75	ns
t_f			10	ns
Q_{g(on)}	V _{GS} = 10 V, V _{DS} = 0.5 • V _{DSS} , I _D = 0.5 • I _{D25}		190	nC
Q_{gs}			40	nC
Q_{gd}			86	nC
R_{thJC}			0.26	K/W
R_{thCK}			0.05	K/W

Symbol	Test Conditions	Characteristic Values		
		(T _J = 25°C, unless otherwise specified)		
		min.	typ.	max.
I_S	V _{GS} = 0 V			48 A
I_{SM}	Repetitive; pulse width limited by T _{JM}			192 A
V_{SD}	I _F = I _S , V _{GS} = 0 V, Pulse test, t ≤ 300 μs, duty cycle d ≤ 2 %			1.5 V
t_{rr}	I _F = 25A, -di/dt = 100 A/μs, V _R = 100 V			250 ns
Q_{RM}			1.0	μC
I_{RM}			10	A

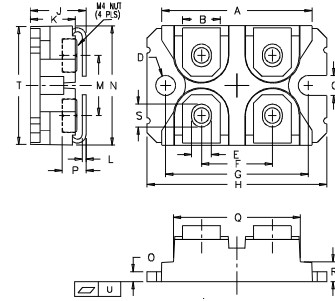
miniBLOC, SOT-227 B

M4 screws (4x) supplied

Dim.	Millimeter		Inches	
	Min.	Max.	Min.	Max.
A	31.50	31.88	1.240	1.255
B	7.80	8.20	0.307	0.323
C	4.09	4.29	0.161	0.169
D	4.09	4.29	0.161	0.169
E	4.09	4.29	0.161	0.169
F	14.91	15.11	0.587	0.595
G	30.12	30.30	1.186	1.193
H	38.00	38.23	1.496	1.505
J	11.68	12.22	0.460	0.481
K	8.92	9.60	0.351	0.378
L	0.76	0.84	0.030	0.033
M	12.60	12.85	0.496	0.506
N	25.15	25.42	0.990	1.001
O	1.98	2.13	0.078	0.084
P	4.95	5.97	0.195	0.235
Q	26.54	26.90	1.045	1.059
R	3.94	4.42	0.155	0.174
S	4.72	4.85	0.186	0.191
T	24.59	25.07	0.968	0.987
U	-0.05	0.1	-0.002	0.004

IXYS reserves the right to change limits, test conditions, and dimensions.

Fig. 1. Output Characteristics @ 25 Deg. C

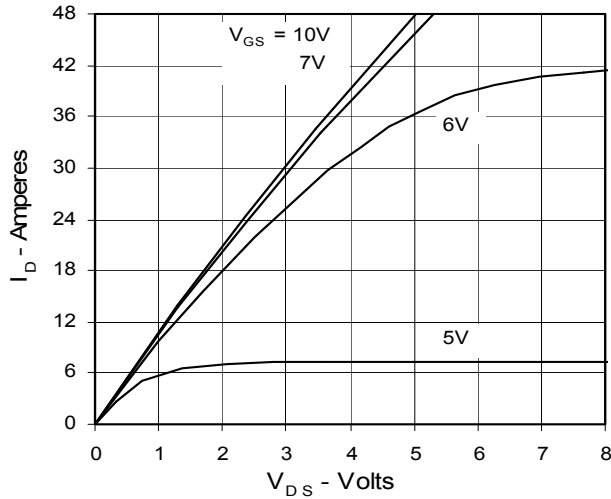

Fig. 2. Extended Output Characteristics @ 25 deg. C

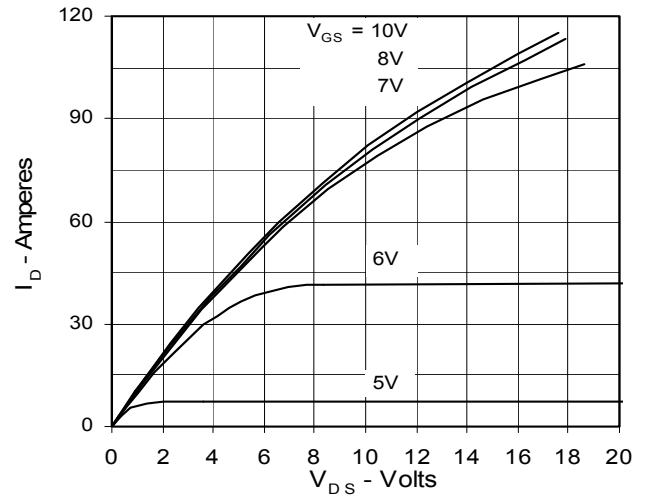

Fig. 3. Output Characteristics @ 125 Deg. C

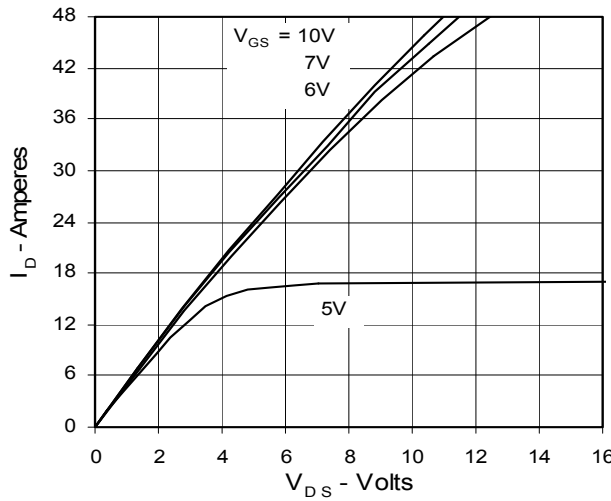

Fig. 4. $R_{DS(on)}$ Normalized to I_{D25} Value vs. Junction Temperature

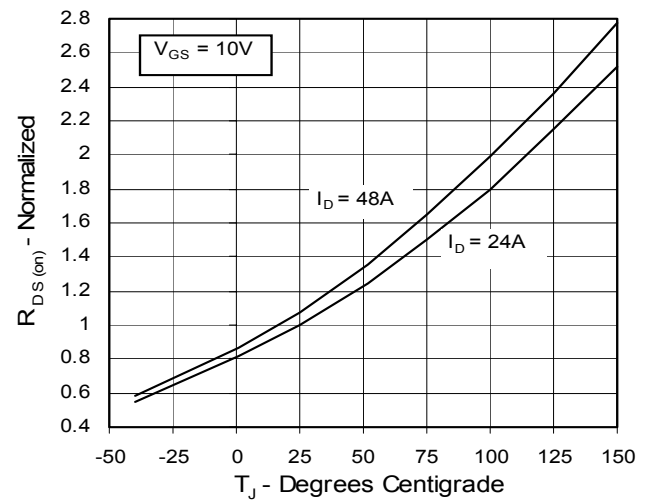

Fig. 5. $R_{DS(on)}$ Normalized to I_{D25} Value vs. I_D

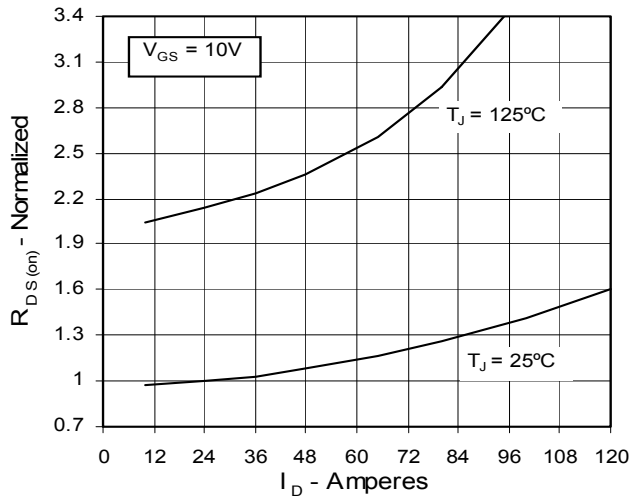

Fig. 6. Drain Current vs. Case Temperature

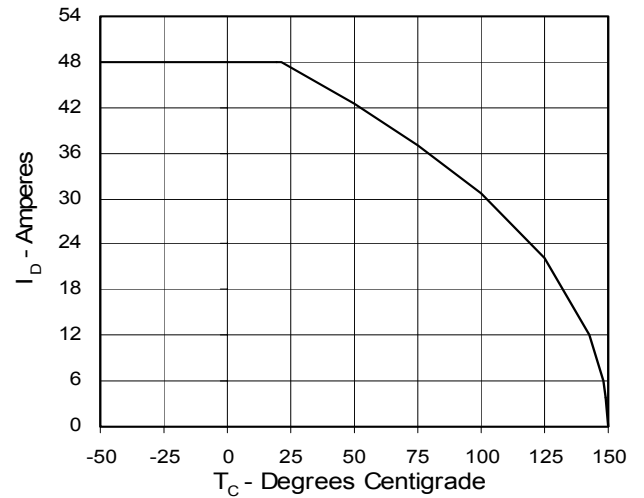

Fig. 7. Input Admittance

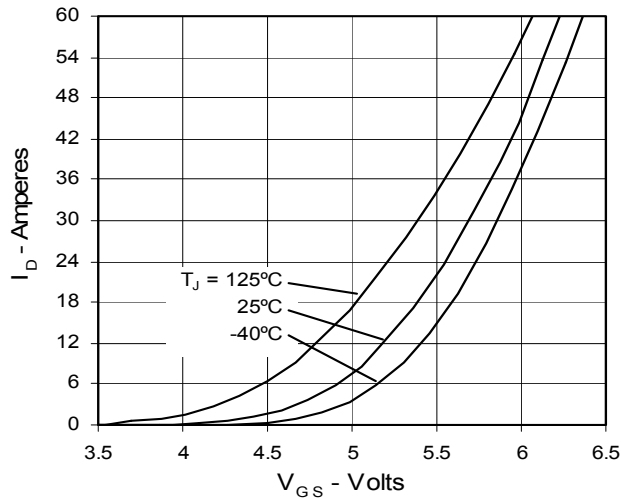

Fig. 8. Transconductance

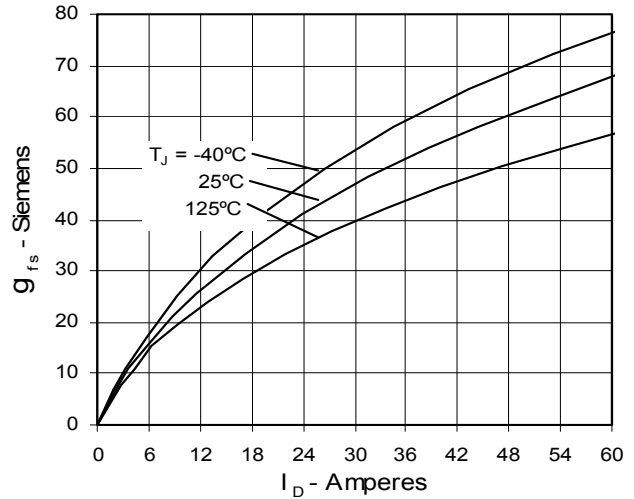

Fig. 9. Source Current vs. Source-To-Drain Voltage

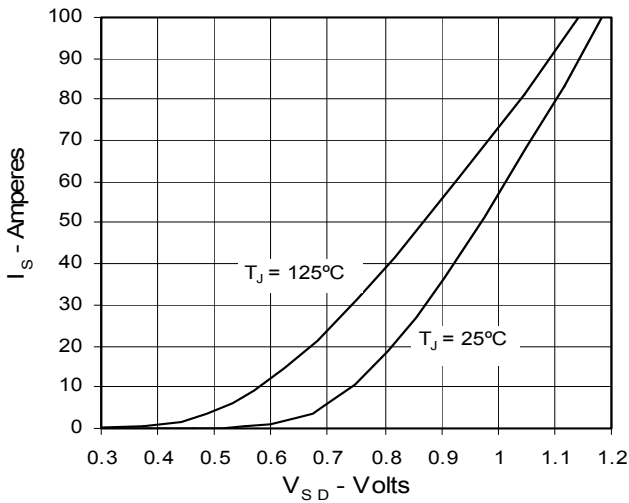

Fig. 10. Gate Charge

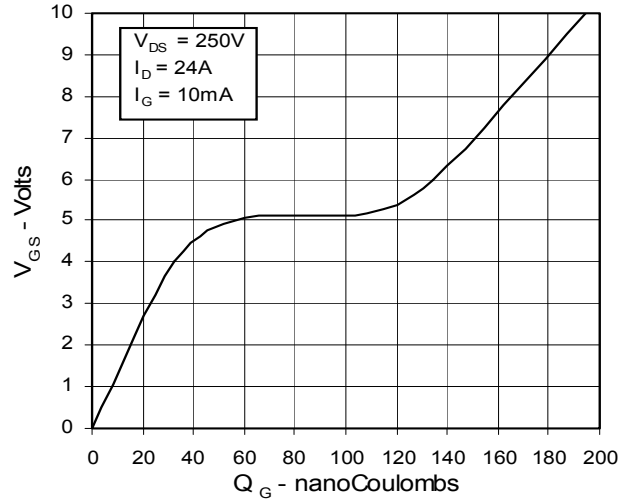

Fig. 11. Capacitance

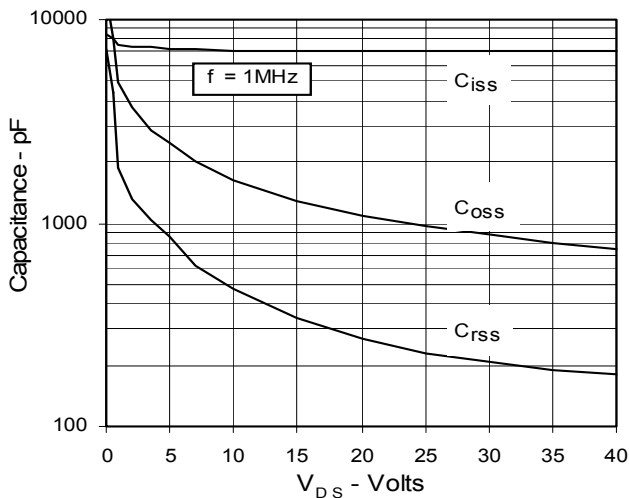
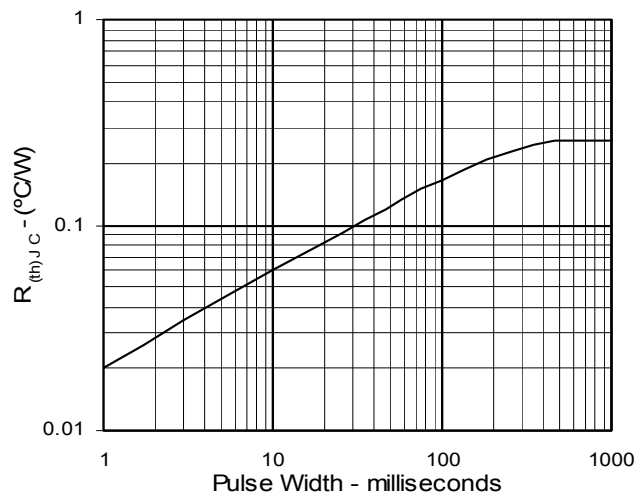

Fig. 12. Maximum Transient Thermal Resistance



IXYS reserves the right to change limits, test conditions, and dimensions.



Disclaimer Notice - Information furnished is believed to be accurate and reliable. However, users should independently evaluate the suitability of and test each product selected for their own applications. Littelfuse products are not designed for, and may not be used in, all applications. Read complete Disclaimer Notice at www.littelfuse.com/disclaimer-electronics.