

High Voltage HiPerFET Power MOSFET

IXFH 6N120

$$\begin{aligned} V_{DSS} &= 1200 \text{ V} \\ I_{D(\text{cont})} &= 6 \text{ A} \\ R_{DS(\text{on})} &= 2.6 \Omega \\ t_{rr} &\leq 300 \text{ ns} \end{aligned}$$

N-Channel Enhancement Mode
Avalanche Rated

Preliminary Data Sheet



Symbol	Test Conditions	Maximum Ratings	
V_{DSS}	$T_J = 25^\circ\text{C}$ to 150°C	1200	V
V_{DGR}	$T_J = 25^\circ\text{C}$ to 150°C ; $R_{GS} = 1 \text{ M}\Omega$	1200	V
V_{GS}	Continuous	± 20	V
V_{GSM}	Transient	± 30	V
I_{D25}	$T_C = 25^\circ\text{C}$	6	A
I_{DM}	$T_C = 25^\circ\text{C}$, pulse width limited by T_{JM}	24	A
I_{AR}	$T_C = 25^\circ\text{C}$	6	A
E_{AR}	$T_C = 25^\circ\text{C}$	25	mJ
E_{AS}	$T_C = 25^\circ\text{C}$	500	mJ
dv/dt	$I_S \leq I_{DM}$, $di/dt \leq 100 \text{ A}/\mu\text{s}$, $V_{DD} \leq V_{DSS}$, $T_J \leq 150^\circ\text{C}$, $R_G = 2 \Omega$	10	V/ns
P_D	$T_C = 25^\circ\text{C}$	300	W
T_J		-55 ... +150	$^\circ\text{C}$
T_{JM}		150	$^\circ\text{C}$
T_{stg}		-55 ... +150	$^\circ\text{C}$
T_L	1.6 mm (0.062 in.) from case for 10 s	300	$^\circ\text{C}$
M_d	Mounting torque	1.13/10	Nm/lb.in.
Weight	TO-247 AD	6	g

TO-247 AD (IXTH)

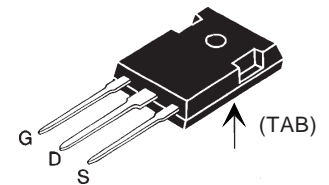

G = Gate, D = Drain,
S = Source, TAB = Drain

Features

- International standard packages
- Low $R_{DS(\text{on})}$ HDMOS™ process
- Rugged polysilicon gate cell structure
- Unclamped Inductive Switching (UIS) rated
- Low package inductance
- easy to drive and to protect

Advantages

- Easy to mount
- Space savings
- High power density

Symbol	Test Conditions ($T_J = 25^\circ\text{C}$, unless otherwise specified)	Characteristic Values		
		Min.	Typ.	Max.
V_{DSS}	$V_{GS} = 0 \text{ V}$, $I_D = 250 \mu\text{A}$	1200		V
$V_{GS(\text{th})}$	$V_{DS} = V_{GS}$, $I_D = 2.5 \text{ mA}$	3.0		V
I_{GSS}	$V_{GS} = \pm 20 \text{ V}_{DC}$, $V_{DS} = 0$			$\pm 100 \text{ nA}$
I_{DSS}	$V_{DS} = V_{DSS}$, $V_{GS} = 0 \text{ V}$	$T_J = 25^\circ\text{C}$		50 μA
		$T_J = 125^\circ\text{C}$		1500 μA
$R_{DS(\text{on})}$	$V_{GS} = 10 \text{ V}$, $I_D = 0.5 I_{D25}$ Pulse test, $t \leq 300 \mu\text{s}$, duty cycle $d \leq 2 \%$			2.6 Ω

Symbol	Test Conditions	Characteristic Values		
		(T _J = 25°C, unless otherwise specified)		
		Min.	Typ.	Max.
g_{fs}	V _{DS} = 20 V; I _D = 0.5 I _{D25} , pulse test	3	5	S
C_{iss}	V _{GS} = 0 V, V _{DS} = 25 V, f = 1 MHz		1950	pF
C_{oss}			175	pF
C_{rss}			60	pF
t_{d(on)}	V _{GS} = 10 V, V _{DS} = 0.5 V _{DSS} , I _D = 0.5 I _{D25} R _G = 4.7 Ω (External)		28	ns
t_r			33	ns
t_{d(off)}			42	ns
t_f			18	ns
Q_{g(on)}	V _{GS} = 10 V, V _{DS} = 0.5 V _{DSS} , I _D = 0.5 I _{D25}		56	nC
Q_{gs}			13	nC
Q_{gd}			25	nC
R_{thJC}	(TO-247)		0.42	K/W
R_{thCK}			0.21	K/W

Source-Drain Diode

Symbol	Test Conditions	Characteristic Values		
		(T _J = 25°C, unless otherwise specified)		
		min.	typ.	max.
I_S	V _{GS} = 0 V			6 A
I_{SM}	Repetitive			24 A
V_{SD}	I _F = I _S , V _{GS} = 0 V, Pulse test, t ≤ 300 μs, duty cycle d ≤ 2 %			1.5 V
t_{rr}	I _F = 6 A, di/dt ≤ 100 A/μs			300 ns
Q_{RM}			0.6	uC
I_{RM}			3.0	A

TO-247 AD Outline

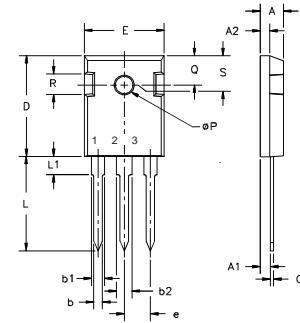

Terminals: 1 - Gate 2 - Drain
3 - Source Tab - Drain

Dim.	Millimeter		Inches	
	Min.	Max.	Min.	Max.
A	4.7	5.3	.185	.209
A ₁	2.2	2.54	.087	.102
A ₂	2.2	2.6	.059	.098
b	1.0	1.4	.040	.055
b ₁	1.65	2.13	.065	.084
b ₂	2.87	3.12	.113	.123
C	.4	.8	.016	.031
D	20.80	21.46	.819	.845
E	15.75	16.26	.610	.640
e	5.20	5.72	0.205	0.225
L	19.81	20.32	.780	.800
L1		4.50		.177
ØP	3.55	3.65	.140	.144
Q	5.89	6.40	0.232	0.252
R	4.32	5.49	.170	.216
S	6.15	BSC	.242	BSC

IXYS reserves the right to change limits, test conditions, and dimensions.

Fig. 1. Output Characteristics
@ 25 Deg. C

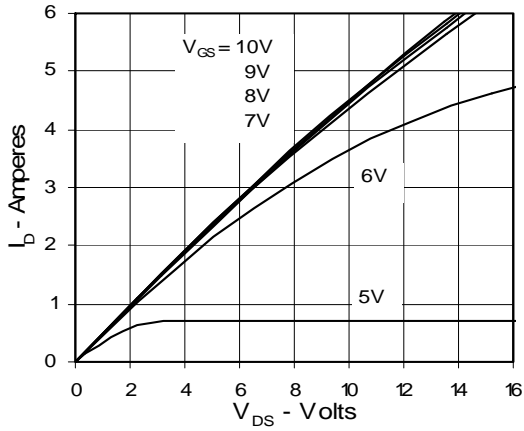

Fig. 2. Extended Output Characteristics
@ 25 deg. C

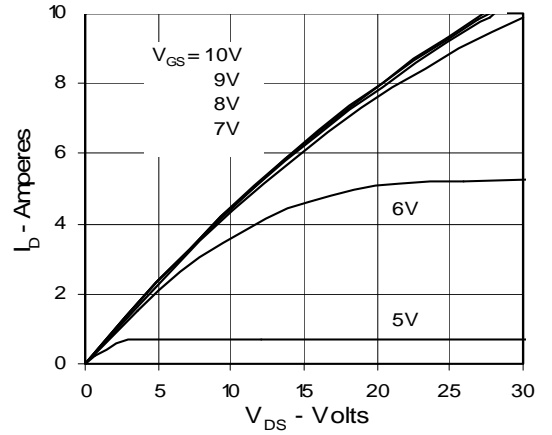

Fig. 3. Output Characteristics
@ 125 Deg. C

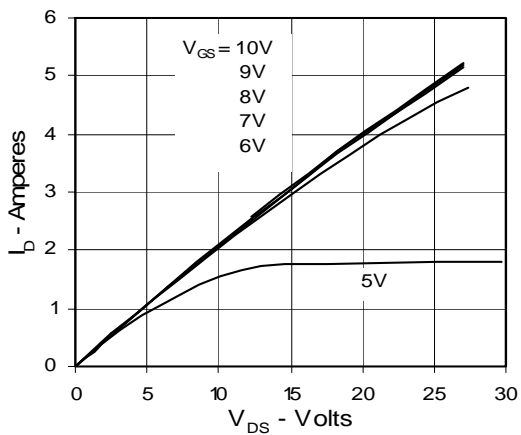

Fig. 4. $R_{DS(on)}$ Normalized to I_{D25} Value vs. Junction Temperature

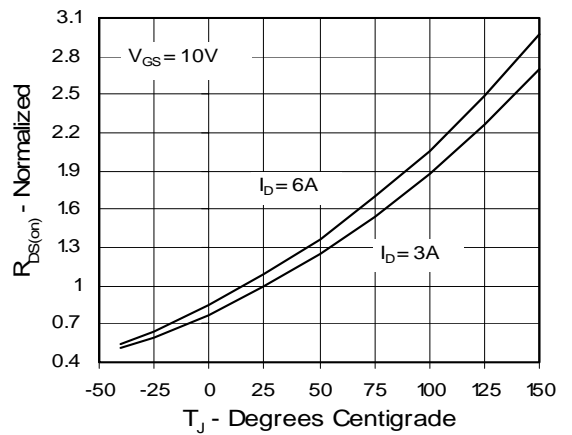

Fig. 5. $R_{DS(on)}$ Normalized to I_{D25} Value vs. I_D

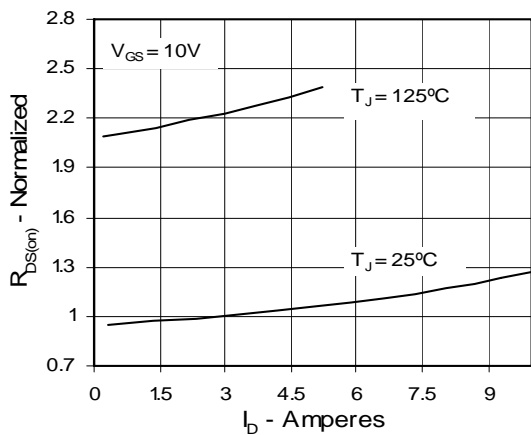

Fig. 6. Drain Current vs. Case Temperature

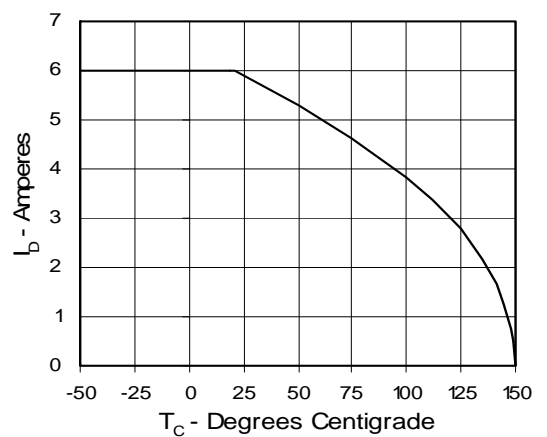

Fig. 7. Input Admittance

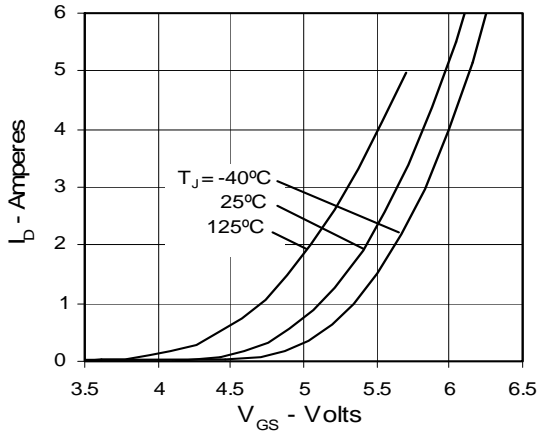

Fig. 8. Transconductance

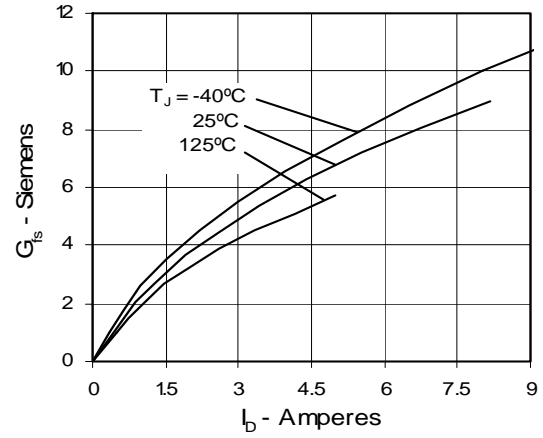

Fig. 9. Source Current vs. Source-To-Drain Voltage

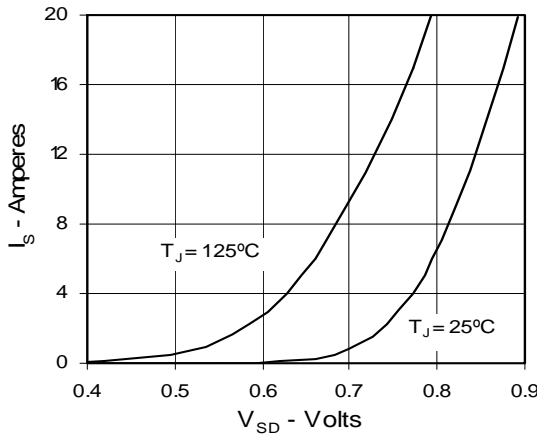

Fig. 10. Gate Charge

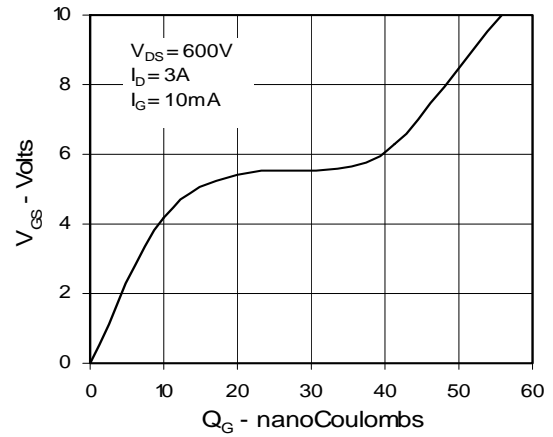

Fig. 11. Capacitance

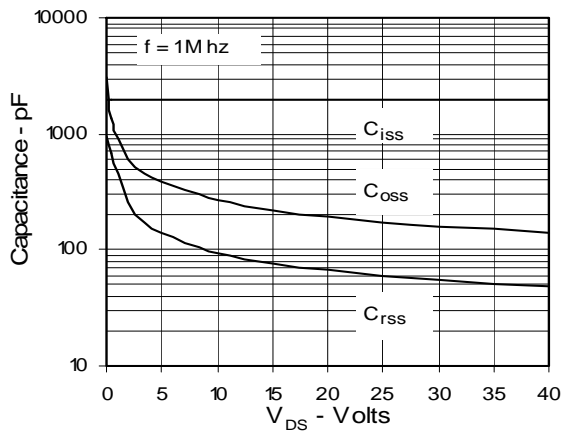
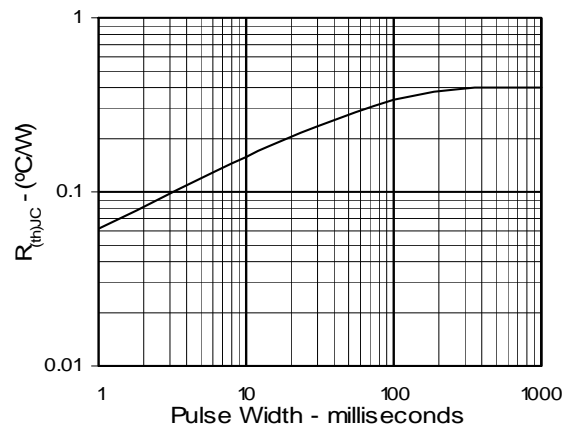

Fig. 12. Maximum Transient Thermal Resistance



IXYS reserves the right to change limits, test conditions, and dimensions.

IXYS MOSFETs and IGBTs are covered by one or more of the following U.S. patents:

4,835,592 4,881,106 5,017,508 5,049,961 5,187,117 5,486,715 6,306,728B1 6,259,123B1 6,306,728B1
4,850,072 4,931,844 5,034,796 5,063,307 5,237,481 5,381,025 6,404,065B1 6,162,665 6,534,343



Disclaimer Notice - Information furnished is believed to be accurate and reliable. However, users should independently evaluate the suitability of and test each product selected for their own applications. Littelfuse products are not designed for, and may not be used in, all applications. Read complete Disclaimer Notice at www.littelfuse.com/disclaimer-electronics.