

HiPerFET™ Power MOSFETs

IXFH/IXFT/IXFX14N100
IXFH/IXFT/IXFX15N100

V_{DSS}	I_{D25}	$R_{DS(on)}$
1000 V	14 A	0.75 Ω
1000 V	15 A	0.70 Ω

$t_{rr} \leq 200$ ns

N-Channel Enhancement Mode
High dv/dt, Low t_{rr} , HDMOS™ Family

Preliminary data sheet

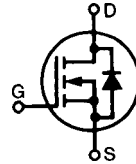

Symbol	Test Conditions	Maximum Ratings	
V_{DSS}	$T_J = 25^\circ\text{C}$ to 150°C	1000	V
V_{DGR}	$T_J = 25^\circ\text{C}$ to 150°C ; $R_{GS} = 1$ M Ω	1000	V
V_{GS}	Continuous	± 20	V
V_{GSM}	Transient	± 30	V
I_{D25}	$T_C = 25^\circ\text{C}$	14N100: 14 15N100: 15	A
I_{DM}	$T_C = 25^\circ\text{C}$, pulse width limited by T_{JM}	14N100: 56 15N100: 60	A
I_{AR}	$T_C = 25^\circ\text{C}$	14N100: 14 15N100: 15	A
E_{AR}	$T_C = 25^\circ\text{C}$	45	mJ
dv/dt	$I_S \leq I_{DM}$, $di/dt \leq 100$ A/ μs , $V_{DD} \leq V_{DSS}$, $T_J \leq 150^\circ\text{C}$, $R_G = 2$ Ω	5	V/ns
P_D	$T_C = 25^\circ\text{C}$	360	W
T_J		-55 ... +150	$^\circ\text{C}$
T_{JM}		150	$^\circ\text{C}$
T_{stg}		-55 ... +150	$^\circ\text{C}$
T_L	1.6 mm (0.062 in.) from case for 10 s	300	$^\circ\text{C}$
M_d	Mounting torque	1.13/10	Nm/lb.in.
Weight		6	g

TO-247 AD
(IXFH)

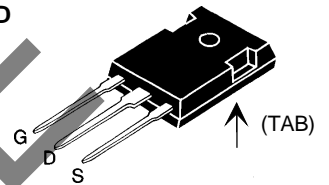

PLUS 247™
(IXFX)

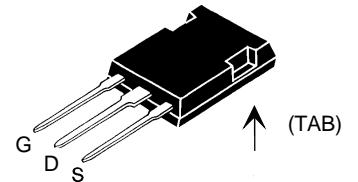

TO-268 (D3)
(IXFT)

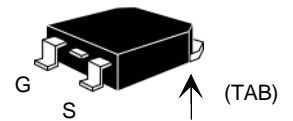

Features

- International standard packages
- Low $R_{DS(on)}$ HDMOS™ process
- Rugged polysilicon gate cell structure
- Unclamped Inductive Switching (UIS) rated
- Low package inductance
- easy to drive and to protect
- Fast intrinsic Rectifier

Applications

- DC-DC converters
- Battery chargers
- Switched-mode and resonant-mode power supplies
- DC choppers
- AC motor control
- Temperature and lighting controls

Advantages

- Easy to mount with 1 screw (TO-247) (isolated mounting screw hole) or mounting clip or spring (PLUS 247™)
- High power surface mountable package
- High power density

Symbol	Test Conditions	Characteristic Values ($T_J = 25^\circ\text{C}$, unless otherwise specified)		
		min.	typ.	max.
V_{DSS}	$V_{GS} = 0$ V, $I_D = 1$ mA	1000		V
$V_{GS(th)}$	$V_{DS} = V_{GS}$, $I_D = 4$ mA	2.5		V
I_{GSS}	$V_{GS} = \pm 20$ V _{DC} , $V_{DS} = 0$			± 100 nA
I_{DSS}	$V_{DS} = 0.8 \cdot V_{DSS}$, $T_J = 25^\circ\text{C}$ $V_{GS} = 0$ V, $T_J = 125^\circ\text{C}$			250 μA 1 mA
$R_{DS(on)}$	$V_{GS} = 10$ V, $I_D = 0.5 \cdot I_{D25}$ Pulse test, $t \leq 300$ μs , duty cycle $d \leq 2\%$			0.75 Ω 0.70 Ω

Symbol	Test Conditions	Characteristic Values ($T_J = 25^\circ\text{C}$, unless otherwise specified)		
		min.	typ.	max.
g_{fs}	$V_{DS} = 10\text{ V}; I_D = 0.5 \cdot I_{D25}$, pulse test	6	10	S
C_{iss} C_{oss} C_{rss}	$V_{GS} = 0\text{ V}, V_{DS} = 25\text{ V}, f = 1\text{ MHz}$		4500	pF
			430	pF
			150	pF
$t_{d(on)}$ t_r $t_{d(off)}$ t_f	$V_{GS} = 10\text{ V}, V_{DS} = 0.5 \cdot V_{DSS}, I_D = 0.5 \cdot I_{D25}$ $R_G = 2\ \Omega$ (External),		27	ns
			30	ns
			120	ns
			30	ns
$Q_{g(on)}$ Q_{gs} Q_{gd}	$V_{GS} = 10\text{ V}, V_{DS} = 0.5 \cdot V_{DSS}, I_D = 0.5 \cdot I_{D25}$		220	nC
			30	nC
			85	nC
R_{thJC} R_{thCK}	(TO-247 Case Style)	0.25	0.35	K/W K/W

TO-247 AD (IXFH) Outline

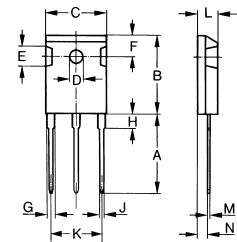

Dim.	Millimeter		Inches	
	Min.	Max.	Min.	Max.
A	19.81	20.32	0.780	0.800
B	20.80	21.46	0.819	0.845
C	15.75	16.26	0.610	0.640
D	3.55	3.65	0.140	0.144
E	4.32	5.49	0.170	0.216
F	5.4	6.2	0.212	0.244
G	1.65	2.13	0.065	0.084
H	-	4.5	-	0.177
J	1.0	1.4	0.040	0.055
K	10.8	11.0	0.426	0.433
L	4.7	5.3	0.185	0.209
M	0.4	0.8	0.016	0.031
N	1.5	2.49	0.087	0.102

Source-Drain Diode

Characteristic Values
($T_J = 25^\circ\text{C}$, unless otherwise specified)

Symbol	Test Conditions	Characteristic Values		
		min.	typ.	max.
I_S	$V_{GS} = 0\text{ V}$	14N100 15N100		14 A 15 A
I_{SM}	Repetitive; pulse width limited by T_{JM}	14N100 15N100		56 A 60 A
V_{SD}	$I_F = I_S, V_{GS} = 0\text{ V}$, Pulse test, $t \leq 300\ \mu\text{s}$, duty cycle $d \leq 2\%$			1.5 V
t_{rr}	$I_F = I_S$ $-di/dt = 100\text{ A}/\mu\text{s}$, $V_R = 100\text{ V}$	$T_J = 25^\circ\text{C}$		200 ns
		$T_J = 125^\circ\text{C}$		350 ns
Q_{RM}		$T_J = 25^\circ\text{C}$	1	μC
		$T_J = 125^\circ\text{C}$	2	μC
I_{RM}		$T_J = 25^\circ\text{C}$	10	A
		$T_J = 125^\circ\text{C}$	15	A

PLUS247™ (IXFX) Outline

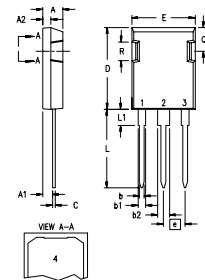

Dim.	Millimeter		Inches	
	Min.	Max.	Min.	Max.
A	4.83	5.21	.190	.205
A ₁	2.29	2.54	.090	.100
A ₂	1.91	2.16	.075	.085
b	1.14	1.40	.045	.055
b ₁	1.91	2.13	.075	.084
b ₂	2.92	3.12	.115	.123
C	0.61	0.80	.024	.031
D	20.80	21.34	.819	.840
E	15.75	16.13	.620	.635
e	5.45 BSC		.215 BSC	
L	19.81	20.32	.780	.800
L ₁	3.81	4.32	.150	.170
Q	5.59	6.20	.220	.244
R	4.32	4.83	.170	.190

TO-268AA (D³ PAK)

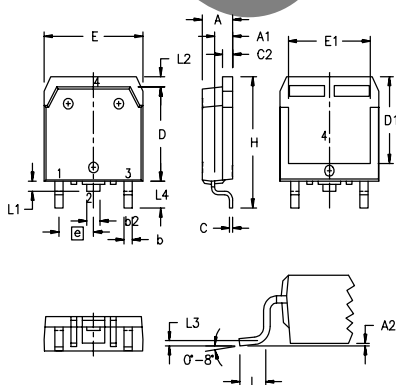

Dim.	Millimeter		Inches	
	Min.	Max.	Min.	Max.
A	4.9	5.1	.193	.201
A ₁	2.7	2.9	.106	.114
A ₂	.02	.25	.001	.010
b	1.15	1.45	.045	.057
b ₂	1.9	2.1	.75	.83
C	.4	.65	.016	.026
D	13.80	14.00	.543	.551
E	15.85	16.05	.624	.632
E ₁	13.3	13.6	.524	.535
e	5.45 BSC		.215 BSC	
H	18.70	19.10	.736	.752
L	2.40	2.70	.094	.106
L ₁	1.20	1.40	.047	.055
L ₂	1.00	1.15	.039	.045
L ₃	0.25 BSC		.010 BSC	
L ₄	3.80	4.10	.150	.161

Min. Recommended Footprint

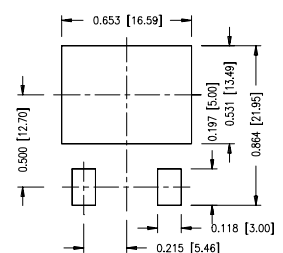

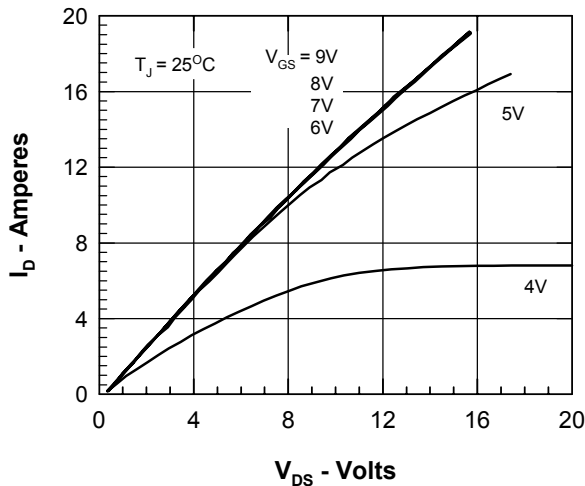

Fig.1 Output Characteristics

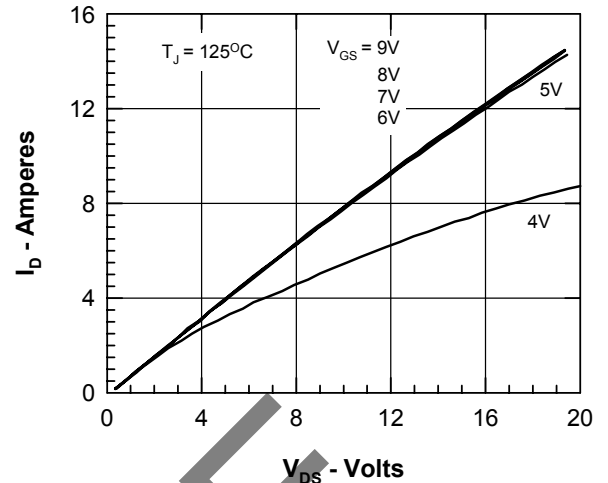

Fig.2 Output characteristics at elevated temperature

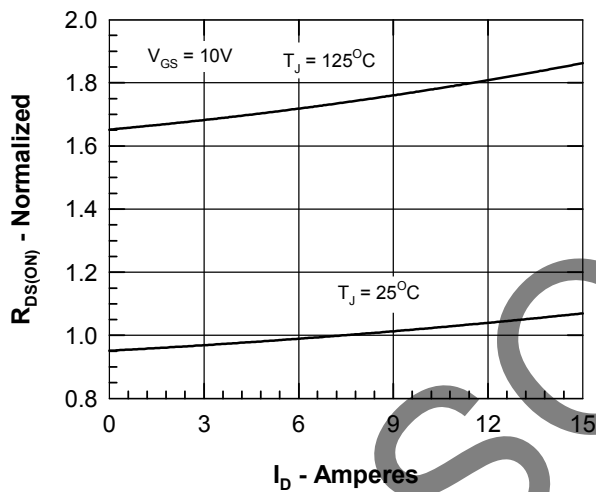

Fig.3 $R_{DS(on)}$ vs. Drain Current

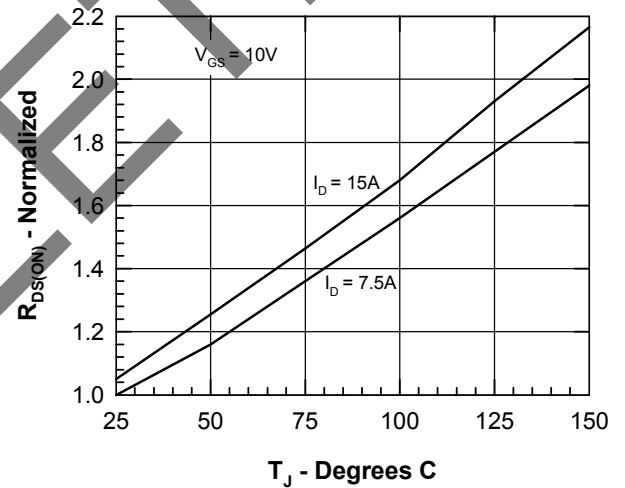

Fig.4 Temperature Dependence of Drain to Source Resistance

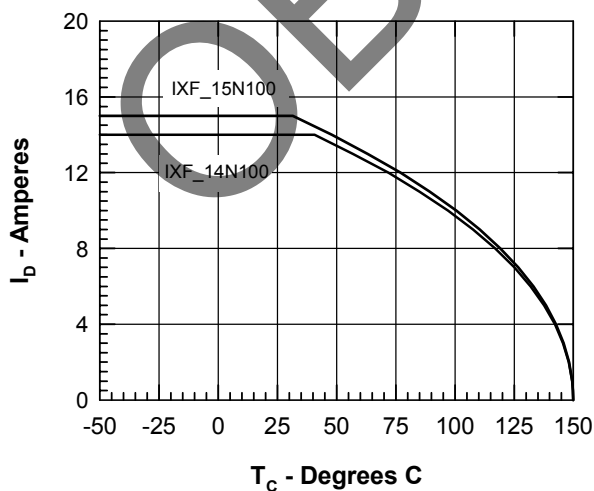

Fig.5 Drain Current vs. Case Temperature

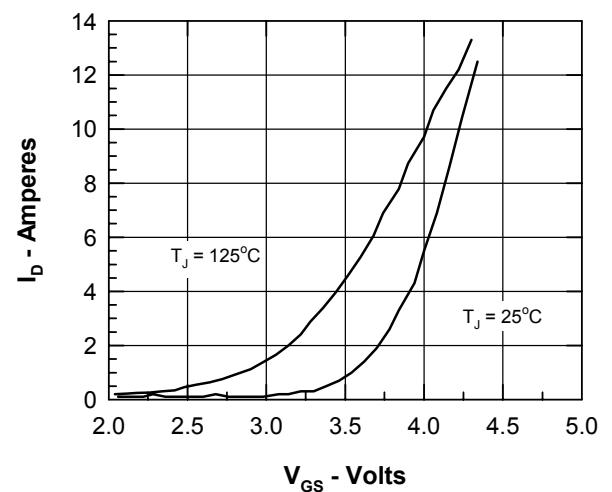

Fig.6 Input admittance

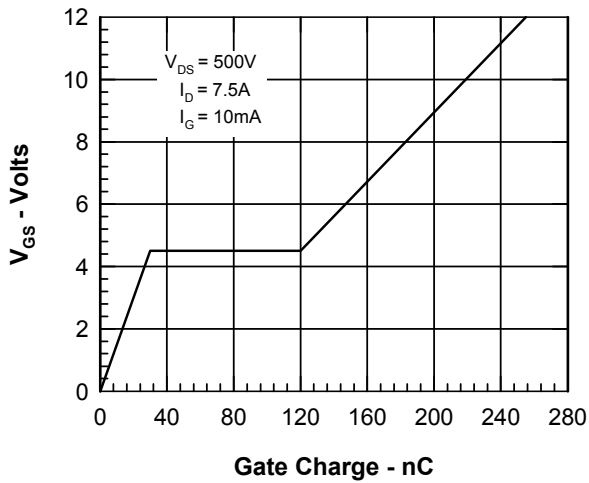

Fig.7 Gate Charge Characteristic Curve

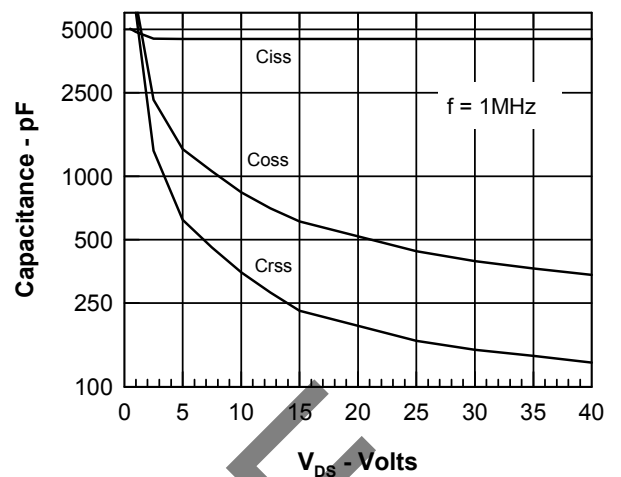

Fig.8 Capacitance Curves

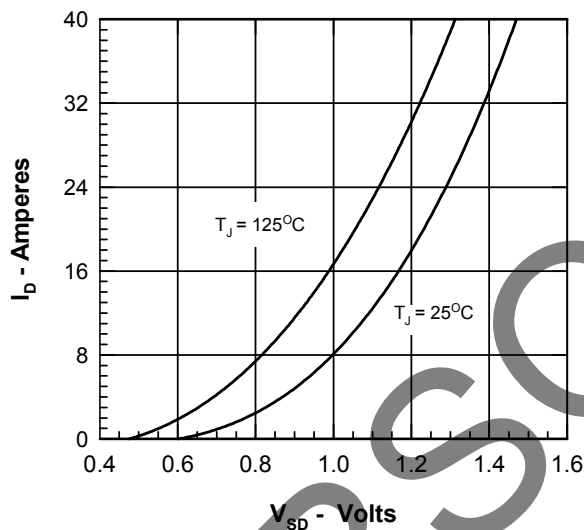

Fig.9 Source current vs Source drain voltage.

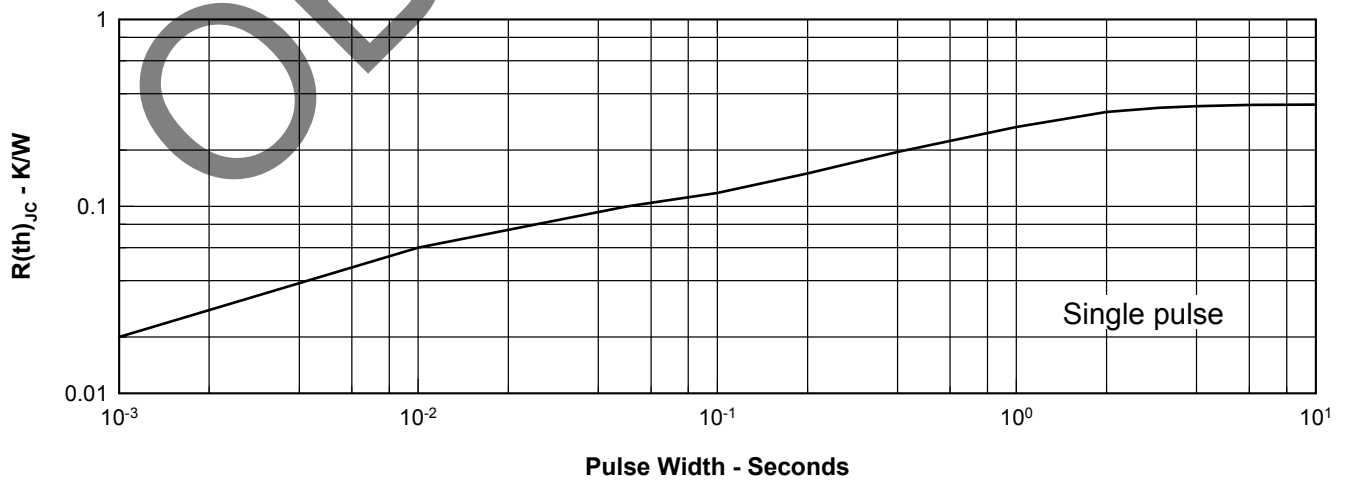

Fig.10 Transient Thermal Impedance



Disclaimer Notice - Information furnished is believed to be accurate and reliable. However, users should independently evaluate the suitability of and test each product selected for their own applications. Littelfuse products are not designed for, and may not be used in, all applications. Read complete Disclaimer Notice at www.littelfuse.com/disclaimer-electronics.