

HiPerFET™

Power MOSFETs

Q2-Class

IXFH14N100Q2

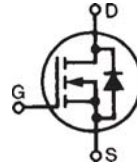

N-Channel Enhancement Mode
 Avalanche Rated, High dv/dt , Low Q_g
 Low intrinsic R_g , low t_{rr}

$$\begin{aligned} V_{DSS} &= 1000V \\ I_{D25} &= 14A \\ R_{DS(on)} &\leq 950m\Omega \\ t_{rr} &\leq 300ns \end{aligned}$$

TO-247 (IXFH)

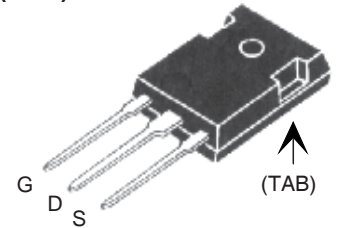

G = Gate
 S = Source

D = Drain
 TAB = Drain

| Symbol | Test Conditions | Maximum Ratings | |
|---------------|--|-----------------|------------------|
| V_{DSS} | $T_J = 25^\circ\text{C}$ to 150°C | 1000 | V |
| V_{DGR} | $T_J = 25^\circ\text{C}$ to 150°C , $R_{GS} = 1M\Omega$ | 1000 | V |
| V_{GSS} | Continuous | ± 30 | V |
| V_{GSM} | Transient | ± 40 | V |
| I_{D25} | $T_C = 25^\circ\text{C}$ | 14 | A |
| I_{DM} | $T_C = 25^\circ\text{C}$, pulse width limited by T_{JM} | 56 | A |
| I_A | $T_C = 25^\circ\text{C}$ | 14 | A |
| E_{AS} | $T_C = 25^\circ\text{C}$ | 2.5 | J |
| dV/dt | $I_S \leq I_{DM}$, $V_{DD} \leq V_{DSS}$, $T_J \leq 150^\circ\text{C}$ | 20 | V/ns |
| P_D | $T_C = 25^\circ\text{C}$ | 500 | W |
| T_J | | -55 ... +150 | $^\circ\text{C}$ |
| T_{JM} | | 150 | $^\circ\text{C}$ |
| T_{stg} | | -55 ... +150 | $^\circ\text{C}$ |
| T_L | 1.6mm (0.063 in) from case for 10s | 300 | $^\circ\text{C}$ |
| M_d | Mounting torque | 1.13/10 | Nm/lb.in. |
| Weight | | 6 | g |

Features

- Double metal process for low gate resistance
- International standard package
- Epoxy meet UL94 V-0, flammability classification
- Avalanche energy and current rated
- Fast intrinsic Rectifier

Applications

- DC-DC converters
- Switched-mode and resonant-mode power supplies, >500kHz switching
- DC choppers
- Pulse generation
- Laser drivers

Advantages

- Easy to mount
- Space savings
- High power density

| Symbol | Test Conditions | Characteristic Values | | |
|--------------|---|-----------------------|------|--------------------------|
| | | Min. | Typ. | Max. |
| V_{DSS} | $V_{GS} = 0V$, $I_D = 250\mu\text{A}$ | 1000 | | V |
| $V_{GS(th)}$ | $V_{DS} = V_{GS}$, $I_D = 4\text{mA}$ | 3.0 | | 5.5 V |
| I_{GSS} | $V_{GS} = \pm 30V$, $V_{DS} = 0V$ | | | ± 200 nA |
| I_{DSS} | $V_{DS} = V_{DSS}$ $V_{GS} = 0V$ | | | 25 μA 1 mA |
| $R_{DS(on)}$ | $V_{GS} = 10V$, $I_D = 0.5 \cdot I_{D25}$, Note 1 | | | 950 m Ω |

| Symbol | Test Conditions ($T_J = 25^\circ\text{C}$, unless otherwise specified) | Characteristic Values | | |
|--------------|---|-----------------------|------|--------------------|
| | | Min. | Typ. | Max. |
| g_{fs} | $V_{DS} = 10\text{V}, I_D = 0.5 \cdot I_{D25}$, Note 1 | 15 | 28 | S |
| C_{iss} | $V_{GS} = 0\text{V}, V_{DS} = 25\text{V}, f = 1\text{MHz}$ | | 2800 | pF |
| C_{oss} | | | 287 | pF |
| C_{rss} | | | 100 | pF |
| $t_{d(on)}$ | Resistive Switching Times | | 12 | ns |
| t_r | $V_{GS} = 10\text{V}, V_{DS} = 0.5 \cdot V_{DSS}, I_D = 0.5 \cdot I_{D25}$ | | 10 | ns |
| $t_{d(off)}$ | $R_G = 2\Omega$ (External) | | 28 | ns |
| t_f | | | 12 | ns |
| $Q_{g(on)}$ | $V_{GS} = 10\text{V}, V_{DS} = 0.5 \cdot V_{DSS}, I_D = 0.5 \cdot I_{D25}$ | | 83 | nC |
| Q_{gs} | | | 20 | nC |
| Q_{gd} | | | 40 | nC |
| R_{thJC} | | | 0.25 | $^\circ\text{C/W}$ |
| R_{thCK} | | 0.21 | | $^\circ\text{C/W}$ |

Source-Drain Diode

| Symbol | Test Conditions ($T_J = 25^\circ\text{C}$, unless otherwise specified) | Characteristic Values | | |
|----------|---|-----------------------|------|---------------|
| | | Min. | Typ. | Max. |
| I_S | $V_{GS} = 0\text{V}$ | | | 14 A |
| I_{SM} | Repetitive, pulse width limited by T_{JM} | | | 56 A |
| V_{SD} | $I_F = I_S, V_{GS} = 0\text{V}$, Note 1 | | | 1.5 V |
| t_{rr} | $I_F = 25\text{A}, -di/dt = 100\text{A}/\mu\text{s}, V_R = 100\text{V}$ | | 0.8 | 300 ns |
| Q_{RM} | | | 7 | μC |
| I_{RM} | | | | A |

Notes: 1. Pulse test, $t \leq 300\mu\text{s}$; duty cycle, $d \leq 2\%$.

TO-247 (IXFH) Outline

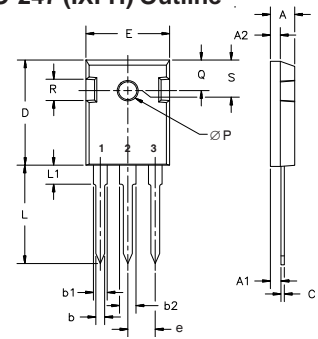

Terminals: 1 - Gate 2 - Drain

| Dim. | Millimeter | | Inches | |
|----------------|------------|-------|--------|-------|
| | Min. | Max. | Min. | Max. |
| A | 4.7 | 5.3 | .185 | .209 |
| A ₁ | 2.2 | 2.54 | .087 | .102 |
| A ₂ | 2.2 | 2.6 | .059 | .098 |
| b | 1.0 | 1.4 | .040 | .055 |
| b ₁ | 1.65 | 2.13 | .065 | .084 |
| b ₂ | 2.87 | 3.12 | .113 | .123 |
| C | .4 | .8 | .016 | .031 |
| D | 20.80 | 21.46 | .819 | .845 |
| E | 15.75 | 16.26 | .610 | .640 |
| e | 5.20 | 5.72 | 0.205 | 0.225 |
| L | 19.81 | 20.32 | .780 | .800 |
| L1 | | 4.50 | | .177 |
| ØP | 3.55 | 3.65 | .140 | .144 |
| Q | 5.89 | 6.40 | 0.232 | 0.252 |
| R | 4.32 | 5.49 | .170 | .216 |

PRELIMINARY TECHNICAL INFORMATION

The product presented herein is under development. The Technical Specifications offered are derived from data gathered during objective characterizations of preliminary engineering lots; but also may yet contain some information supplied during a pre-production design evaluation. IXYS reserves the right to change limits, test conditions, and dimensions without notice.

IXYS reserves the right to change limits, test conditions, and dimensions.

IXYS MOSFETs and IGBTs are covered by one or more of the following U.S. patents:

| | | | | | | | | | |
|-----------|-----------|-----------|-----------|--------------|--------------|--------------|--------------|--------------|--------------|
| 4,835,592 | 4,931,844 | 5,049,961 | 5,237,481 | 6,162,665 | 6,404,065 B1 | 6,683,344 | 6,727,585 | 7,005,734 B2 | 7,157,338 B2 |
| 4,850,072 | 5,017,508 | 5,063,307 | 5,381,025 | 6,259,123 B1 | 6,534,343 | 6,710,405 B2 | 6,759,692 | 7,063,975 B2 | |
| 4,881,106 | 5,034,796 | 5,187,117 | 5,486,715 | 6,306,728 B1 | 6,583,505 | 6,710,463 | 6,771,478 B2 | 7,071,537 | |

Fig. 1. Output Characteristics
 @ 25°C

Fig. 2. Extended Output Characteristics
 @ 25°C

Fig. 3. Output Characteristics
 @ 125°C

Fig. 4. $R_{DS(on)}$ Normalized to 0.5 I_{D25} Value vs. Junction Temperature

Fig. 5. $R_{DS(on)}$ Normalized to 0.5 I_{D25} Value vs. I_D

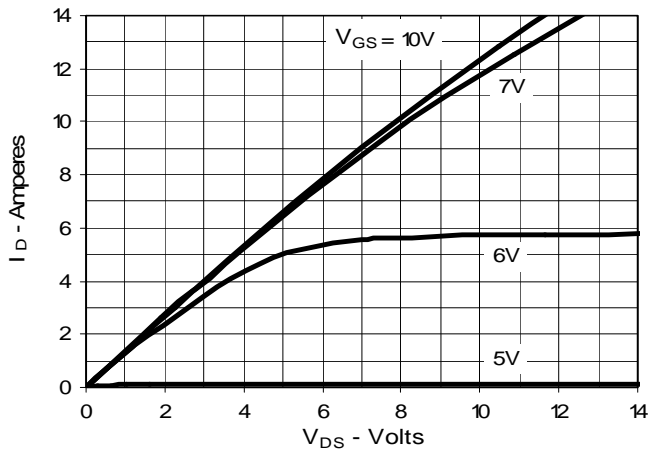
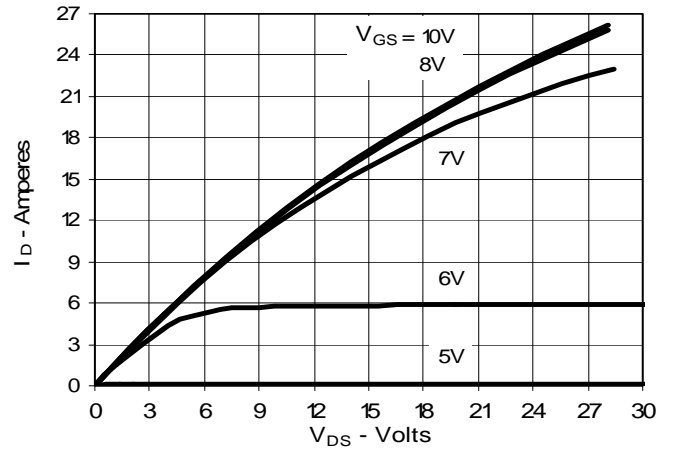
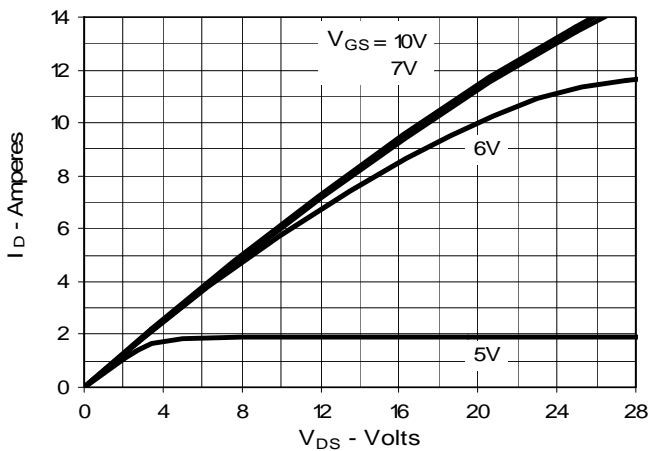
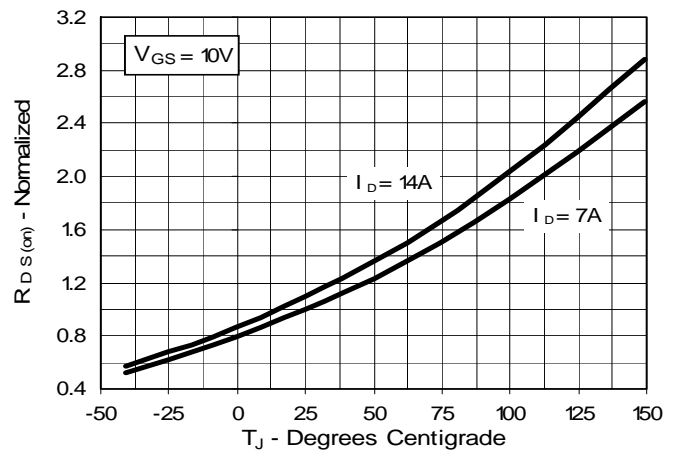
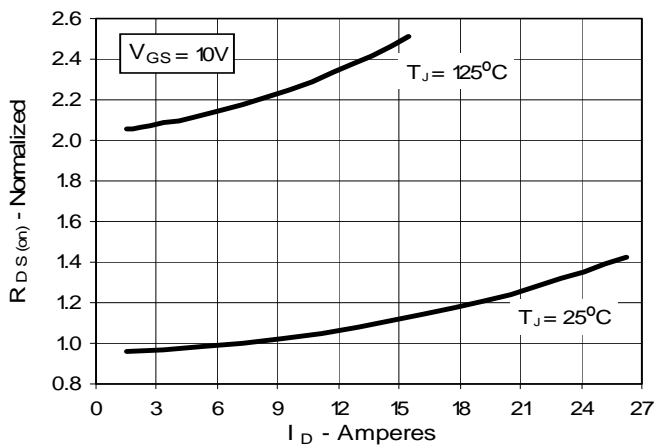
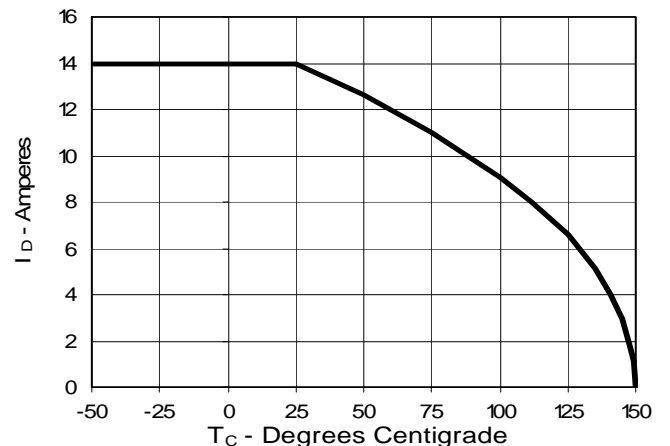
Fig. 6. Drain Current vs. Case Temperature

Fig. 7. Input Admittance

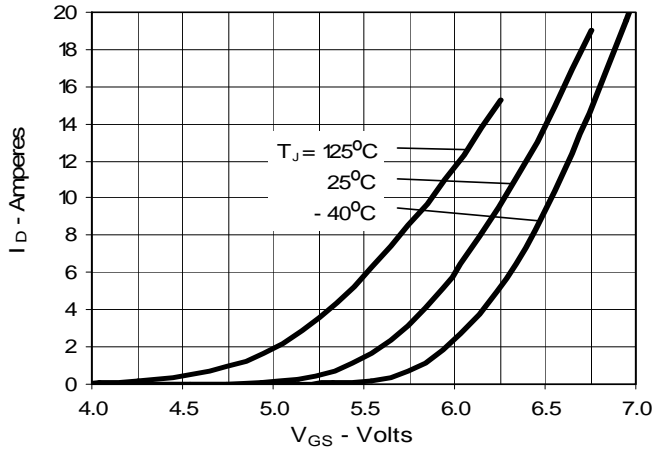

Fig. 8. Transconductance

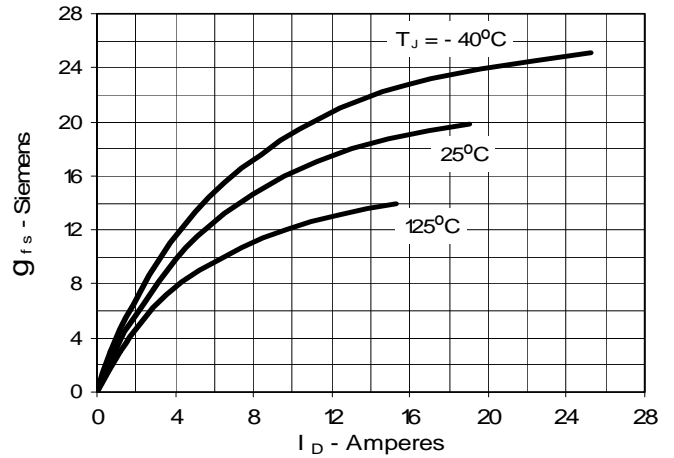

Fig. 9. Source Current vs. Source-To-Drain Voltage

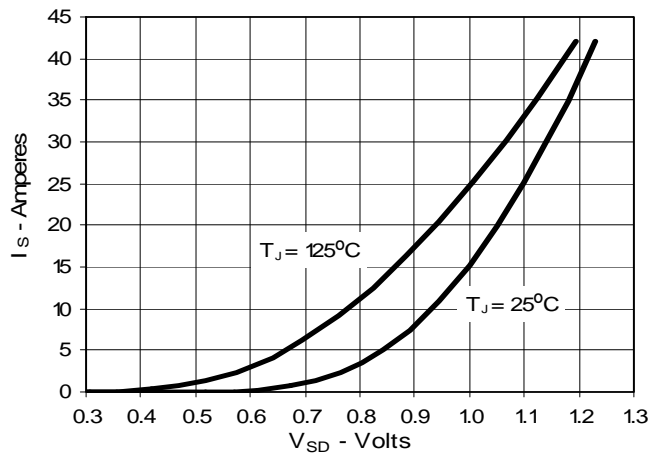

Fig. 10. Gate Charge

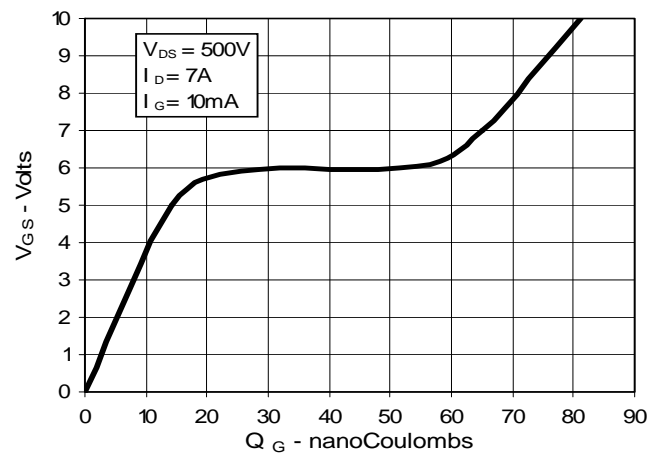

Fig. 11. Capacitance

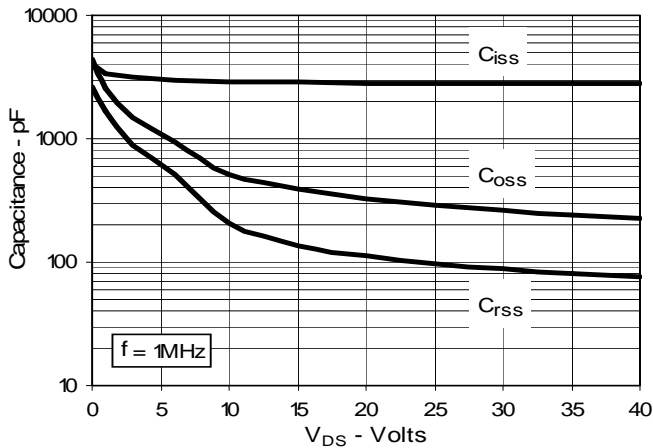
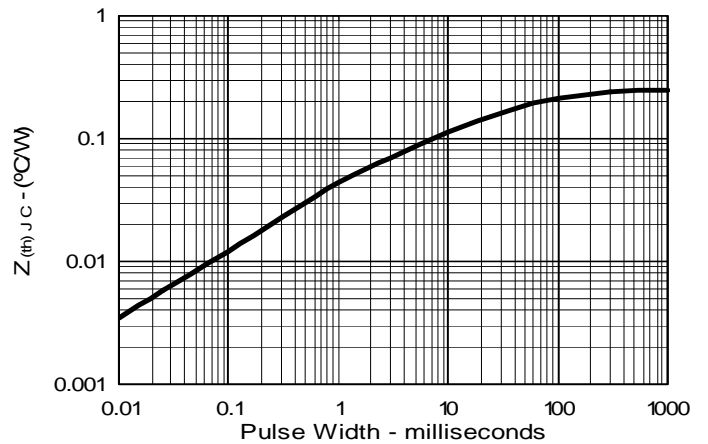

Fig. 12. Maximum Transient Thermal Impedance





Disclaimer Notice - Information furnished is believed to be accurate and reliable. However, users should independently evaluate the suitability of and test each product selected for their own applications. Littelfuse products are not designed for, and may not be used in, all applications. Read complete Disclaimer Notice at www.littelfuse.com/disclaimer-electronics.