

HiPerFET™ Power MOSFET Q2-Class

IXFB38N100Q2

N-Channel Enhancement Mode
Avalanche Rated, Low Q_g , Low Intrinsic R_G
High dV/dt , Low t_{rr}

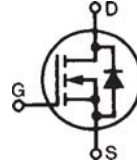

$$\begin{aligned} V_{DSS} &= 1000V \\ I_{D25} &= 38A \\ R_{DS(on)} &\leq 250m\Omega \\ t_{rr} &\leq 300ns \end{aligned}$$

Symbol	Test Conditions	Maximum Ratings	
V_{DSS}	$T_J = 25^\circ C$ to $150^\circ C$	1000	V
V_{DGR}	$T_J = 25^\circ C$ to $150^\circ C$, $R_{GS} = 1M\Omega$	1000	V
V_{GSS}	Continuous	± 30	V
V_{GSM}	Transient	± 40	V
I_{D25}	$T_C = 25^\circ C$	38	A
I_{DM}	$T_C = 25^\circ C$, pulse width limited by T_{JM}	152	A
I_A	$T_C = 25^\circ C$	38	A
E_{AS}	$T_C = 25^\circ C$	5	J
dV/dt	$I_S \leq I_{DM}$, $V_{DD} \leq V_{DSS}$, $T_J \leq 150^\circ C$	20	V/ns
P_D	$T_C = 25^\circ C$	890	W
T_J		-55 ... +150	$^\circ C$
T_{JM}		150	$^\circ C$
T_{stg}		-55 ... +150	$^\circ C$
T_L	1.6 mm (0.063 in.) from case for 10s	300	$^\circ C$
T_{sOLD}	Plastic body for 10s	260	$^\circ C$
F_C	Mounting force	30..120/6.7..27	N / lbs
Weight		10	g

PLUS264™(IXFB)

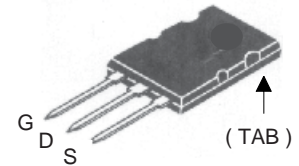

G = Gate D = Drain
S = Source TAB = Drain

Features

- Double metal process for low gate resistance
- Unclamped Inductive Switching (UIS) rated
- Low package inductance
- easy to drive and to protect
- Fast intrinsic rectifier

Applications

- DC-DC converters
- Switched-mode and resonant-mode power supplies, >500kHz switching
- DC choppers
- Pulse generation
- Laser drivers

Advantages

- PLUS 264™ package for clip or spring mounting
- Space savings
- High power density

Symbol	Test Conditions	Characteristic Values ($T_J = 25^\circ C$, unless otherwise specified)		
		Min.	Typ.	Max.
BV_{DSS}	$V_{GS} = 0V$, $I_D = 1mA$	1000		V
$V_{GS(th)}$	$V_{DS} = V_{GS}$, $I_D = 8mA$	3.0		5.5 V
I_{GSS}	$V_{GS} = \pm 30V$, $V_{DS} = 0V$			± 200 nA
I_{DSS}	$V_{DS} = V_{DSS}$ $V_{GS} = 0V$ $T_J = 125^\circ C$			50 μA 3 mA
$R_{DS(on)}$	$V_{GS} = 10V$, $I_D = 0.5 \cdot I_{D25}$, Note 1			250 m Ω

Symbol	Test Conditions ($T_J = 25^\circ\text{C}$, unless otherwise specified)	Characteristic Values		
		Min.	Typ.	Max.
g_{fs}	$V_{DS} = 20\text{V}, I_D = 0.5 \cdot I_{D25}$, Note 1	24	40	S
C_{iss}	$V_{GS} = 0\text{V}, V_{DS} = 25\text{V}, f = 1\text{MHz}$		13.5	nF
C_{oss}			1035	pF
C_{rss}			180	pF
$t_{d(on)}$	Resistive Switching Times $V_{GS} = 10\text{V}, V_{DS} = 0.5 \cdot V_{DSS}, I_D = 0.5 \cdot I_{D25}$ $R_G = 1\Omega$ (External)		25	ns
t_r			28	ns
$t_{d(off)}$			57	ns
t_f			15	ns
$Q_{g(on)}$	$V_{GS} = 10\text{V}, V_{DS} = 0.5 \cdot V_{DSS}, I_D = 0.5 \cdot I_{D25}$		250	nC
Q_{gs}			60	nC
Q_{gd}			105	nC
R_{thJC}			0.14	$^\circ\text{C/W}$
R_{thCS}		0.13		$^\circ\text{C/W}$

Source-Drain Diode

Symbol	Test Conditions ($T_J = 25^\circ\text{C}$, unless otherwise specified)	Characteristic Values		
		Min.	Typ.	Max.
I_S	$V_{GS} = 0\text{V}$			38 A
I_{SM}	Repetitive, pulse width limited by T_{JM}			152 A
V_{SD}	$I_F = I_S, V_{GS} = 0\text{V}$, Note 1			1.5 V
t_{rr}	$I_F = 25\text{A}, V_{GS} = 0\text{V}$ $-di/dt = 100\text{ A}/\mu\text{s}$ $V_R = 100\text{ V}$			300 ns
Q_{RM}			1.4	μC
I_{RM}			9	A

Note: 1. Pulse test, $t \leq 300\mu\text{s}$, duty cycle, $d \leq 2\%$.

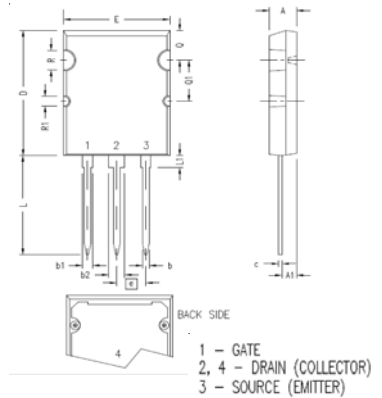
PLUS264™ (IXFB) Outline

SYM	INCHES		MILLIMETERS	
	MIN	MAX	MIN	MAX
A	.185	.209	4.70	5.31
A1	.102	.118	2.59	3.00
b	.037	.055	0.94	1.40
b1	.087	.102	2.21	2.59
b2	.110	.126	2.79	3.20
c	.017	.029	0.43	0.74
D	1.007	1.047	25.58	26.59
E	.760	.799	19.30	20.29
e	.215 BSC		5.46 BSC	
L	.779	.842	19.79	21.39
L1	.087	.102	2.21	2.59
Q	.240	.256	6.10	6.50
Q1	.330	.346	8.38	8.79
ØR	.155	.187	3.94	4.75
ØR1	.085	.093	2.16	2.36

IXYS reserves the right to change limits, test conditions, and dimensions.

IXYS MOSFETs and IGBTs are covered by one or more of the following U.S. patents:	4,835,592	4,931,844	5,049,961	5,237,481	6,162,665	6,404,065 B1	6,683,344	6,727,585	7,005,734 B2	7,157,338B2
	4,850,072	5,017,508	5,063,307	5,381,025	6,259,123 B1	6,534,343	6,710,405 B2	6,759,692	7,063,975 B2	
	4,881,106	5,034,796	5,187,117	5,486,715	6,306,728 B1	6,583,505	6,710,463	6,771,478 B2	7,071,537	

**Fig. 1. Output Characteristics
@ 25°C**

**Fig. 2. Extended Output Characteristics
@ 25°C**

**Fig. 3. Output Characteristics
@ 125°C**

**Fig. 4. $R_{DS(on)}$ Normalized to $I_D = 19A$
Value vs. Junction Temperature**

**Fig. 5. $R_{DS(on)}$ Normalized to $I_D = 19A$
Value vs. Drain Current**

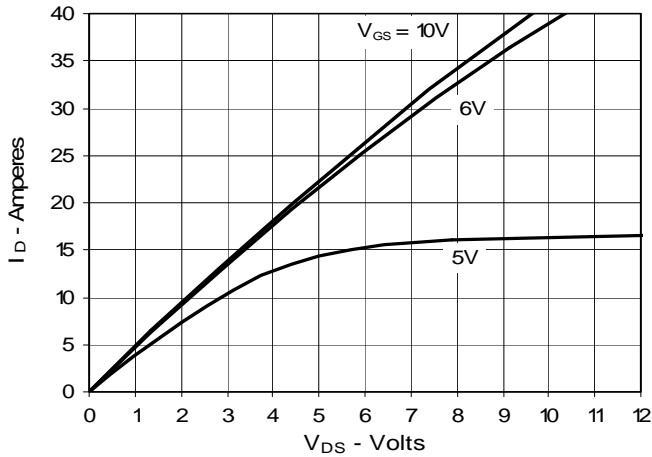
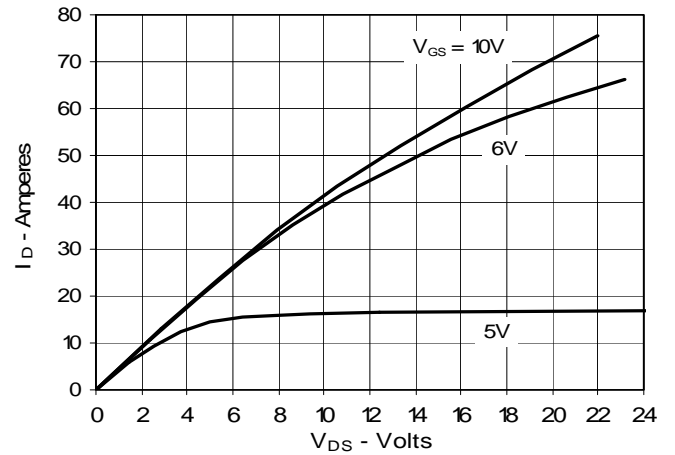
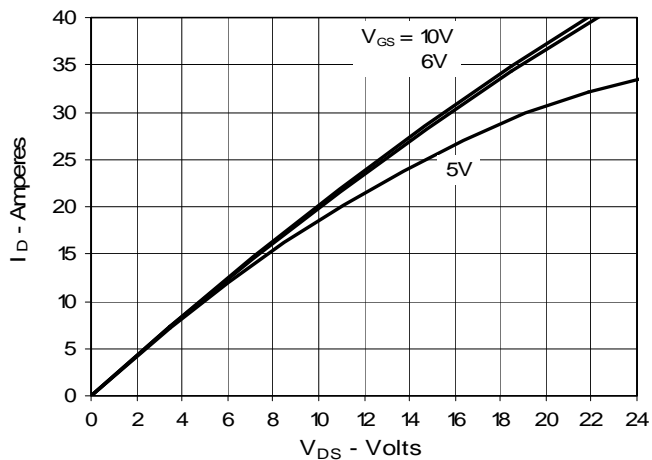
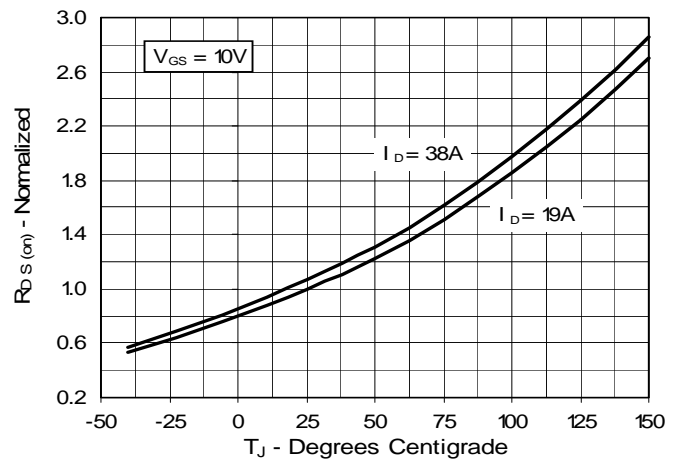
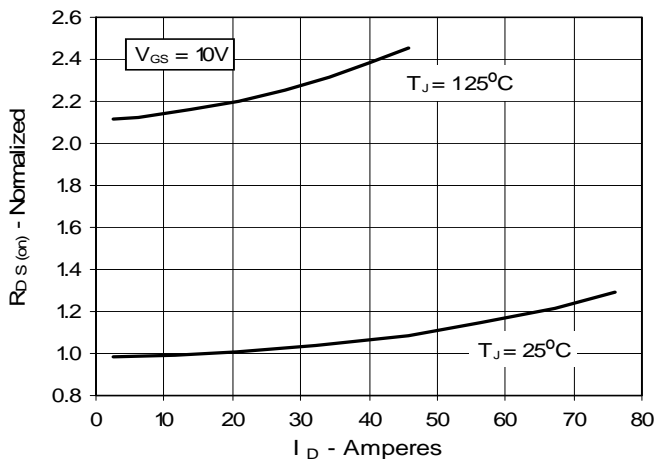
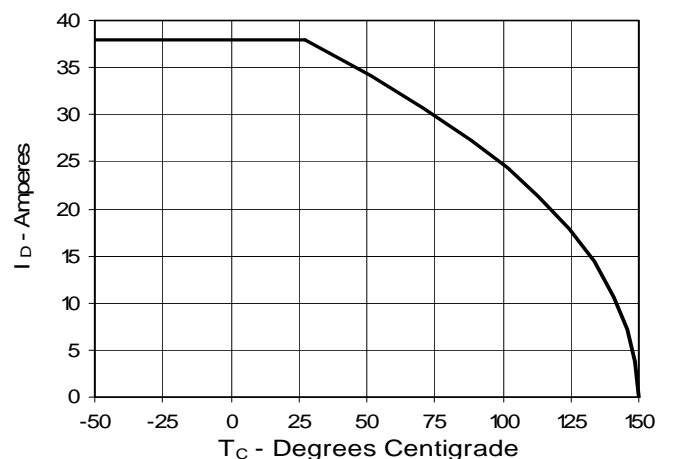
**Fig. 6. Drain Current vs.
Case Temperature**

Fig. 7. Input Admittance

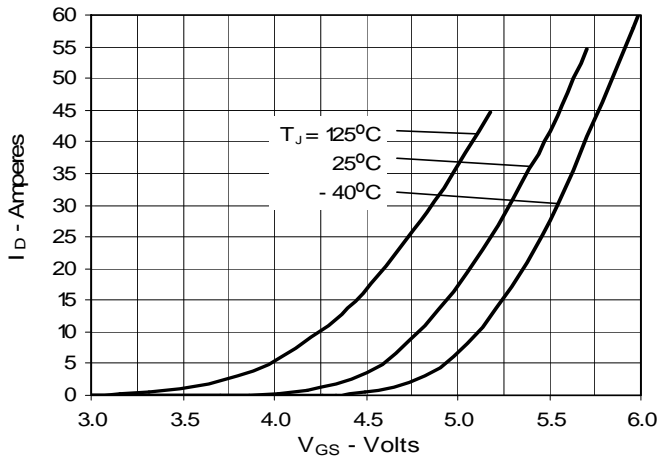

Fig. 8. Transconductance

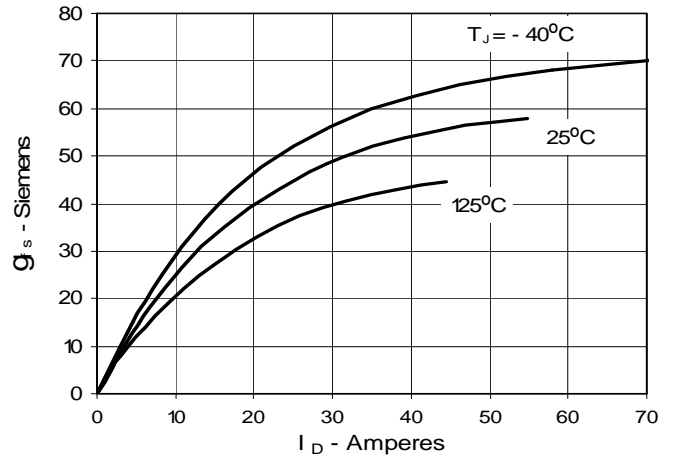

Fig. 9. Source Current vs. Source-To-Drain Voltage

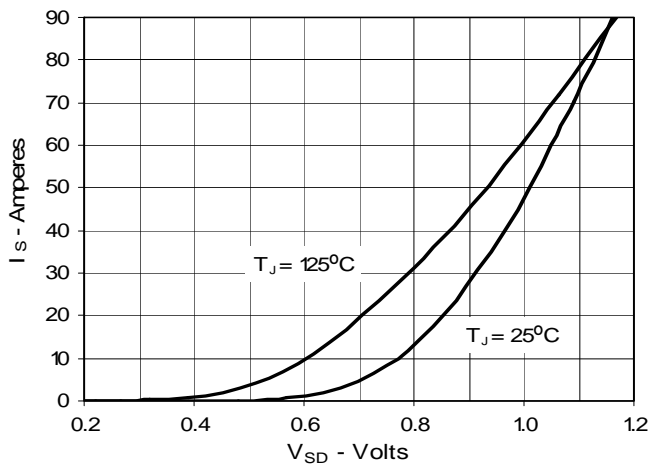

Fig. 10. Gate Charge

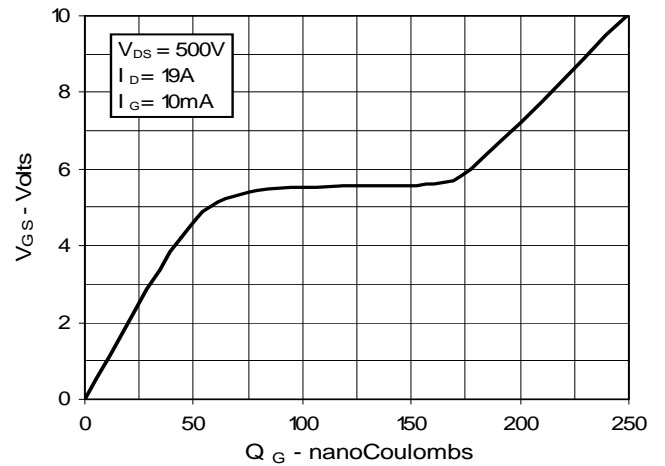

Fig. 11. Capacitance

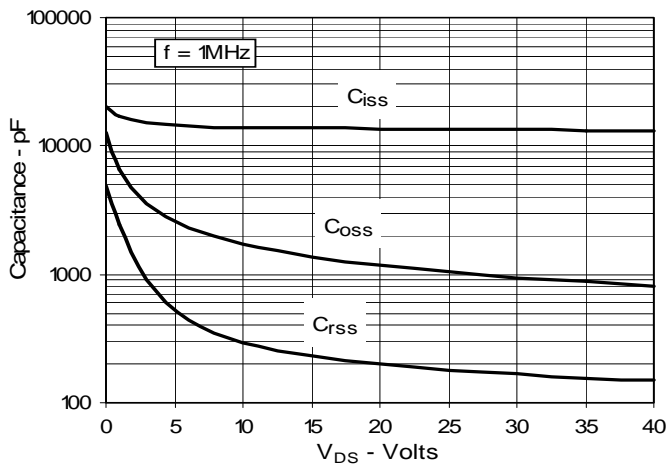
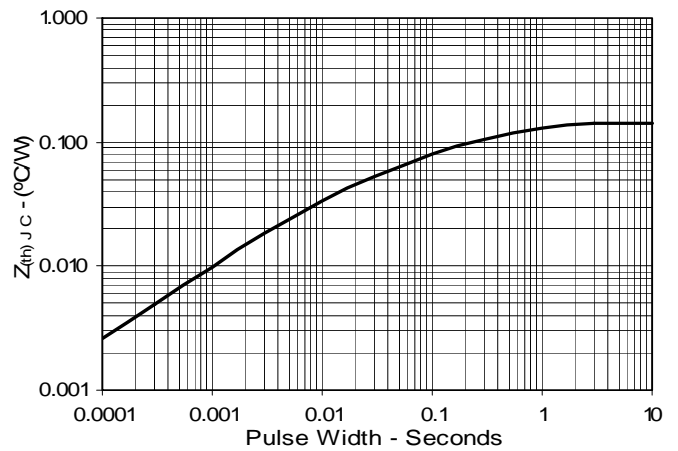

Fig. 12. Maximum Transient Thermal Impedance





Disclaimer Notice - Information furnished is believed to be accurate and reliable. However, users should independently evaluate the suitability of and test each product selected for their own applications. Littelfuse products are not designed for, and may not be used in, all applications. Read complete Disclaimer Notice at www.littelfuse.com/disclaimer-electronics.