

Polar3™ HiPerFET™ Power MOSFET

IXFB110N60P3

$V_{DSS} = 600V$
 $I_{D25} = 110A$
 $R_{DS(on)} \leq 56m\Omega$
 $t_{rr} \leq 250ns$

N-Channel Enhancement Mode
Avalanche Rated
Fast Intrinsic Rectifier



PLUS264™

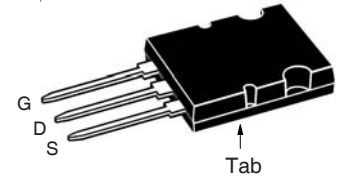

G = Gate D = Drain
 S = Source Tab = Drain

Symbol	Test Conditions	Maximum Ratings	
V_{DSS}	$T_J = 25^\circ C$ to $150^\circ C$	600	V
V_{DGR}	$T_J = 25^\circ C$ to $150^\circ C$, $R_{GS} = 1M\Omega$	600	V
V_{GSS}	Continuous	± 30	V
V_{GSM}	Transient	± 40	V
I_{D25}	$T_C = 25^\circ C$	110	A
I_{DM}	$T_C = 25^\circ C$, Pulse Width Limited by T_{JM}	275	A
I_A	$T_C = 25^\circ C$	55	A
E_{AS}	$T_C = 25^\circ C$	3	J
dv/dt	$I_S \leq I_{DM}$, $V_{DD} \leq V_{DSS}$, $T_J \leq 150^\circ C$	35	V/ns
P_D	$T_C = 25^\circ C$	1890	W
T_J		-55 ... +150	$^\circ C$
T_{JM}		150	$^\circ C$
T_{stg}		-55 ... +150	$^\circ C$
T_L	Maximum Lead Temperature for Soldering	300	$^\circ C$
T_{SOLD}	Plastic Body for 10s	260	$^\circ C$
F_C	Mounting Force	30..120/6.7..27	N/lb
Weight		10	g

Features

- Avalanche Rated
- Low Package Inductance
- Fast Intrinsic Rectifier
- Low $R_{DS(on)}$ and Q_G

Advantages

- Easy to Mount
- Space Savings

Applications

- DC-DC Converters
- Battery Chargers
- Switch-Mode and Resonant-Mode Power Supplies
- Uninterrupted Power Supplies
- AC Motor Drives
- High Speed Power Switching Applications

Symbol	Test Conditions ($T_J = 25^\circ C$ Unless Otherwise Specified)	Characteristic Values		
		Min.	Typ.	Max.
BV_{DSS}	$V_{GS} = 0V$, $I_D = 3mA$	600		V
$V_{GS(th)}$	$V_{DS} = V_{GS}$, $I_D = 8mA$	3.0		5.0 V
I_{GSS}	$V_{GS} = \pm 30V$, $V_{DS} = 0V$			± 200 nA
I_{DSS}	$V_{DS} = V_{DSS}$, $V_{GS} = 0V$ $T_J = 125^\circ C$			50 μA 2.75 mA
$R_{DS(on)}$	$V_{GS} = 10V$, $I_D = 0.5 \cdot I_{DSS}$, Note 1			56 m Ω

Symbol	Test Conditions ($T_J = 25^\circ\text{C}$ Unless Otherwise Specified)	Characteristic Values		
		Min.	Typ.	Max.
g_{fs}	$V_{DS} = 20\text{V}, I_D = 55\text{A}$, Note 1	65	105	S
C_{iss}	$V_{GS} = 0\text{V}, V_{DS} = 25\text{V}, f = 1\text{MHz}$		18	nF
C_{oss}			1550	pF
C_{rss}			8	pF
R_{Gi}	Gate Input Resistance		1.2	Ω
$t_{d(on)}$	Resistive Switching Times $V_{GS} = 10\text{V}, V_{DS} = 0.5 \cdot V_{DSS}, I_D = 0.5 \cdot I_{DSS}$ $R_G = 1\Omega$ (External)		63	ns
t_r			30	ns
$t_{d(off)}$			106	ns
t_f			15	ns
$Q_{g(on)}$		$V_{GS} = 10\text{V}, V_{DS} = 0.5 \cdot V_{DSS}, I_D = 0.5 \cdot I_{DSS}$		254
Q_{gs}			80	nC
Q_{gd}			68	nC
R_{thJC}				0.066 $^\circ\text{C/W}$
R_{thCS}		0.13		$^\circ\text{C/W}$

PLUS264™ (IXFB) Outline

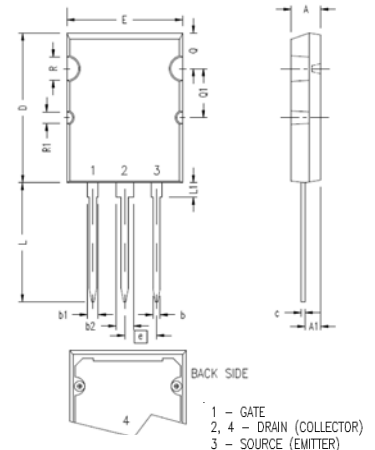

SYM	INCHES		MILLIMETERS	
	MIN	MAX	MIN	MAX
A	.185	.209	4.70	5.31
A1	.102	.118	2.59	3.00
b	.037	.055	0.94	1.40
b1	.087	.102	2.21	2.59
b2	.110	.126	2.79	3.20
c	.017	.029	0.43	0.74
D	1.007	1.047	25.58	26.59
E	.760	.799	19.30	20.29
e	.215 BSC		5.46 BSC	
L	.779	.842	19.79	21.39
L1	.087	.102	2.21	2.59
Q	.240	.256	6.10	6.50
Q1	.330	.346	8.38	8.79
ØR	.155	.187	3.94	4.75
ØR1	.085	.093	2.16	2.36

Source-Drain Diode

Symbol	Test Conditions ($T_J = 25^\circ\text{C}$ Unless Otherwise Specified)	Characteristic Values		
		Min.	Typ.	Max.
I_s	$V_{GS} = 0\text{V}$			110 A
I_{SM}	Repetitive, Pulse Width Limited by T_{JM}			440 A
V_{SD}	$I_F = 100\text{A}, V_{GS} = 0\text{V}$, Note 1			1.5 V
t_{rr}	$I_F = 55\text{A}, -di/dt = 100\text{A}/\mu\text{s}$ $V_R = 100\text{V}, V_{GS} = 0\text{V}$			250 ns
Q_{RM}			1.6	μC
I_{RM}			14.0	A

Note 1. Pulse test, $t \leq 300\mu\text{s}$, duty cycle, $d \leq 2\%$.

IXYS Reserves the Right to Change Limits, Test Conditions, and Dimensions.

IXYS MOSFETs and IGBTs are covered by one or more of the following U.S. patents:

4,835,592	4,931,844	5,049,961	5,237,481	6,162,665	6,404,065 B1	6,683,344	6,727,585	7,005,734 B2	7,157,338B2
4,860,072	5,017,508	5,063,307	5,381,025	6,259,123 B1	6,534,343	6,710,405 B2	6,759,692	7,063,975 B2	
4,881,106	5,034,796	5,187,117	5,486,715	6,306,728 B1	6,583,505	6,710,463	6,771,478 B2	7,071,537	

Fig. 1. Output Characteristics @ $T_J = 25^\circ\text{C}$

Fig. 2. Extended Output Characteristics @ $T_J = 25^\circ\text{C}$

Fig. 3. Output Characteristics @ $T_J = 125^\circ\text{C}$

Fig. 4. $R_{DS(on)}$ Normalized to $I_D = 55\text{A}$ Value vs. Junction Temperature

Fig. 5. $R_{DS(on)}$ Normalized to $I_D = 55\text{A}$ Value vs. Drain Current

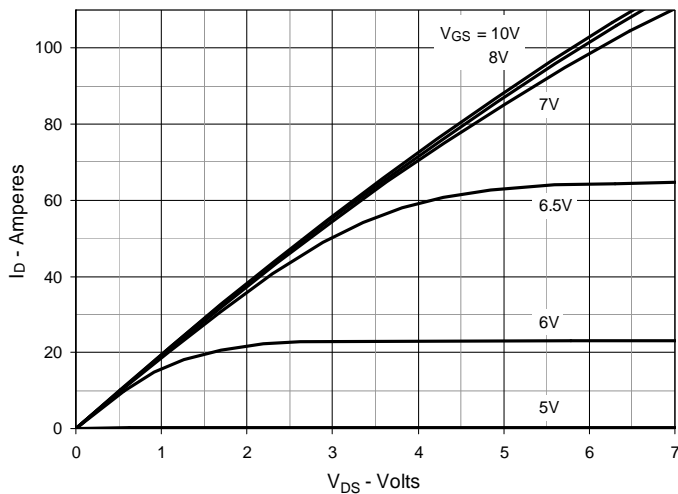
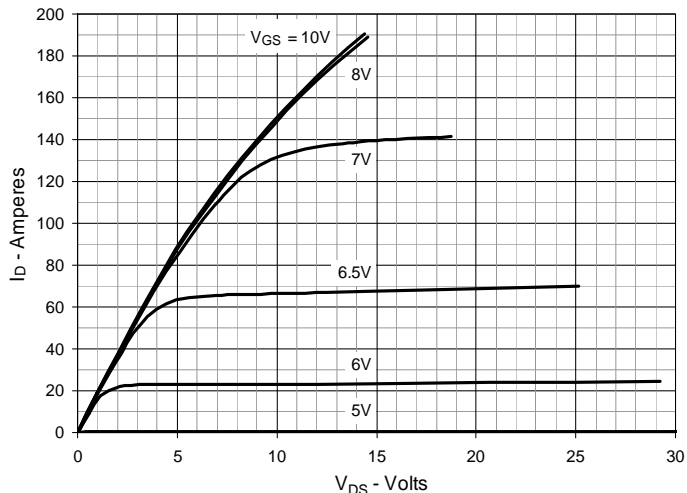
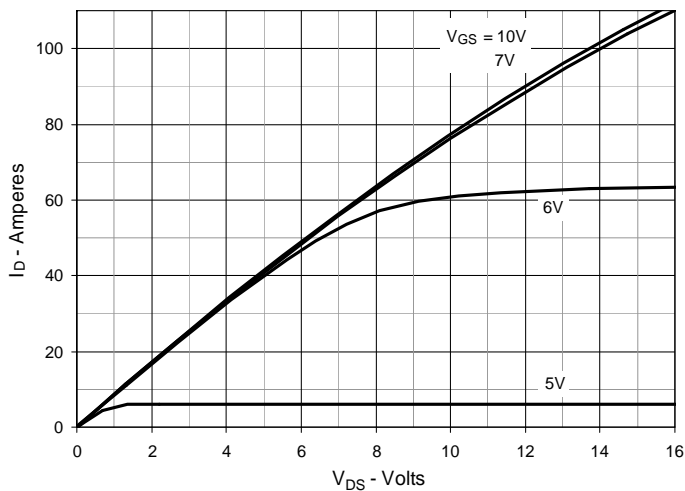
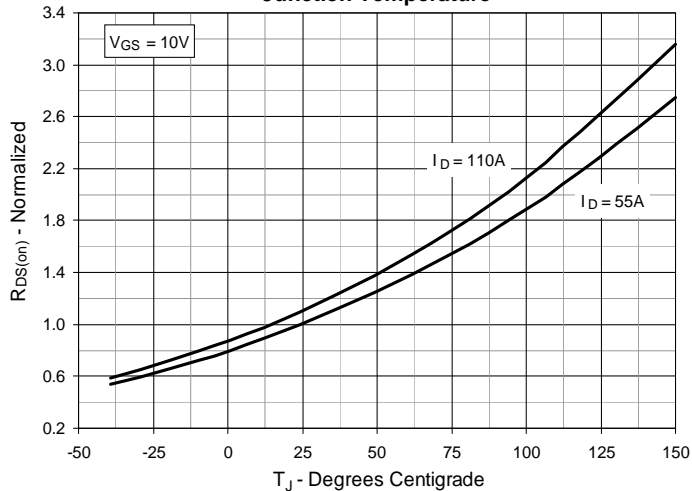
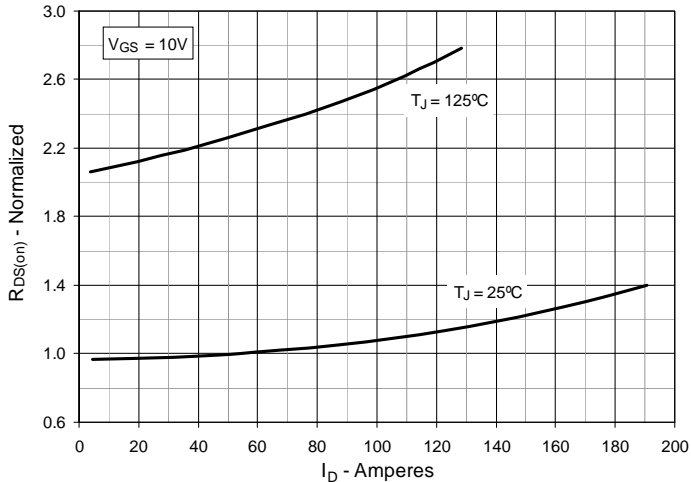
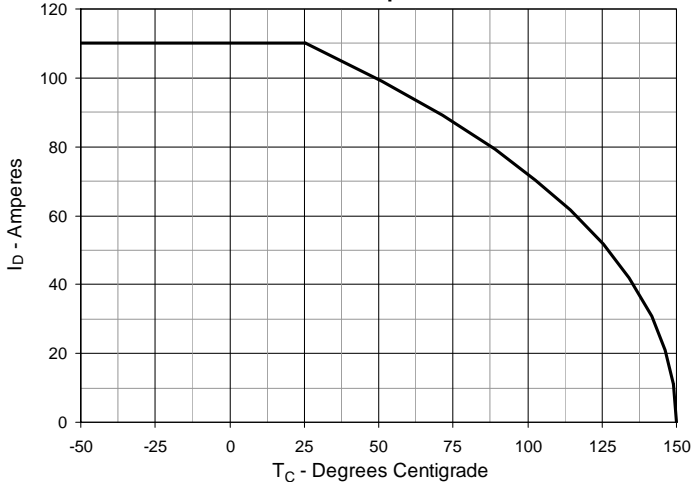
Fig. 6. Maximum Drain Current vs. Case Temperature

Fig. 7. Input Admittance

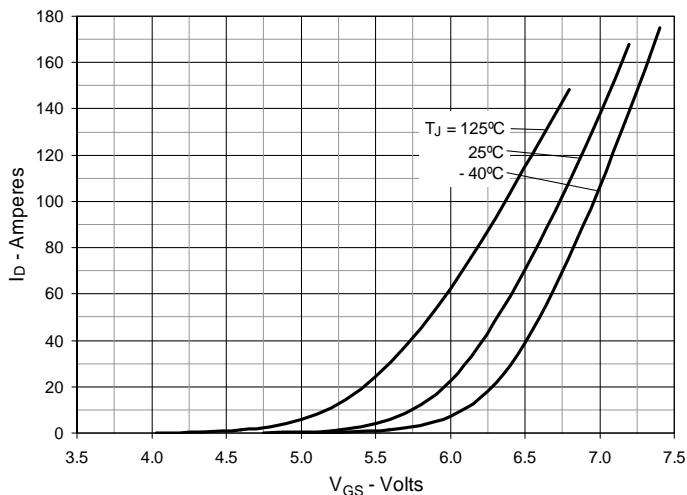

Fig. 8. Transconductance

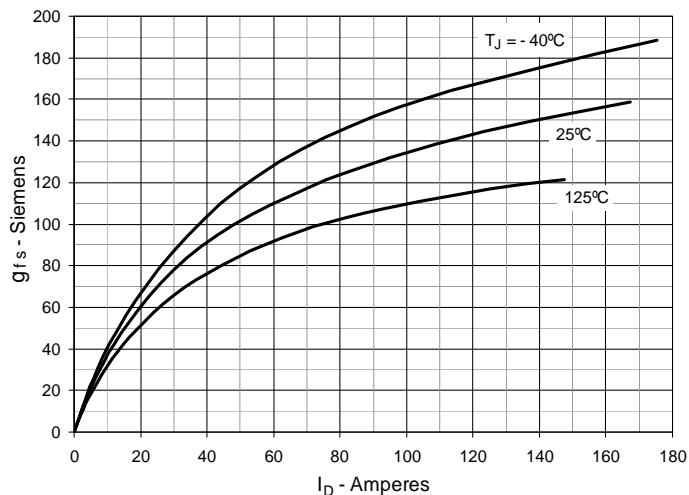

Fig. 9. Forward Voltage Drop of Intrinsic Diode

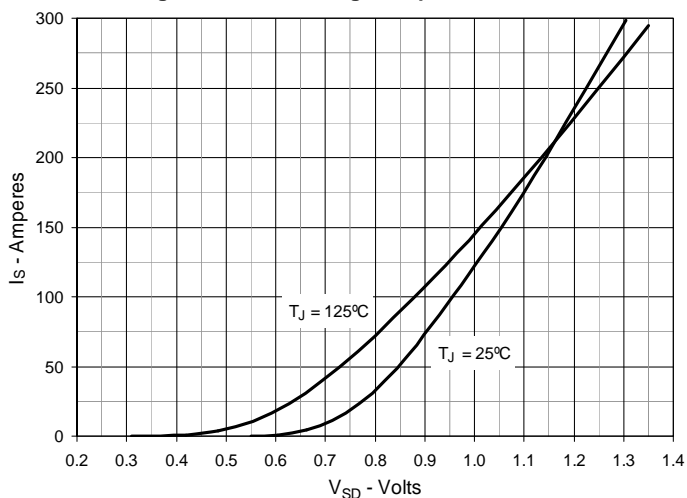

Fig. 10. Gate Charge

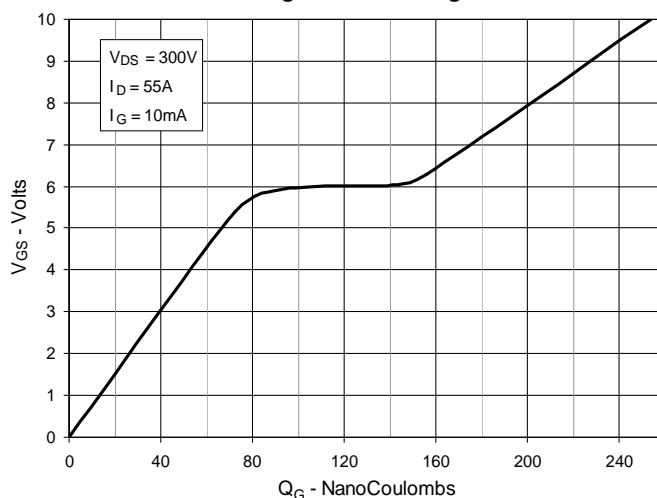

Fig. 11. Capacitance

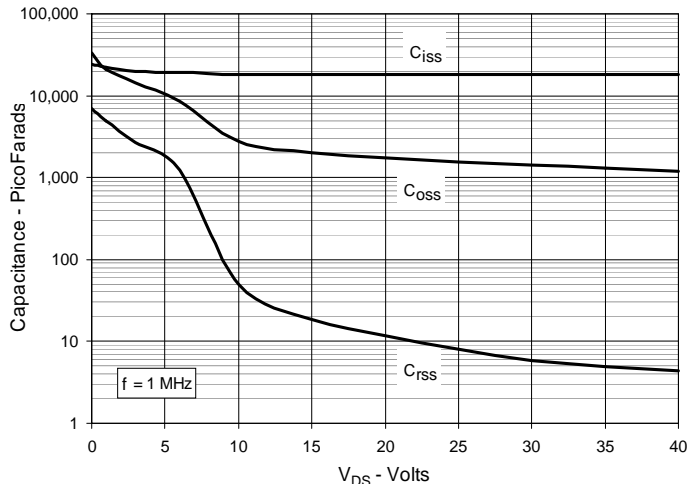

Fig. 12. Forward-Bias Safe Operating Area

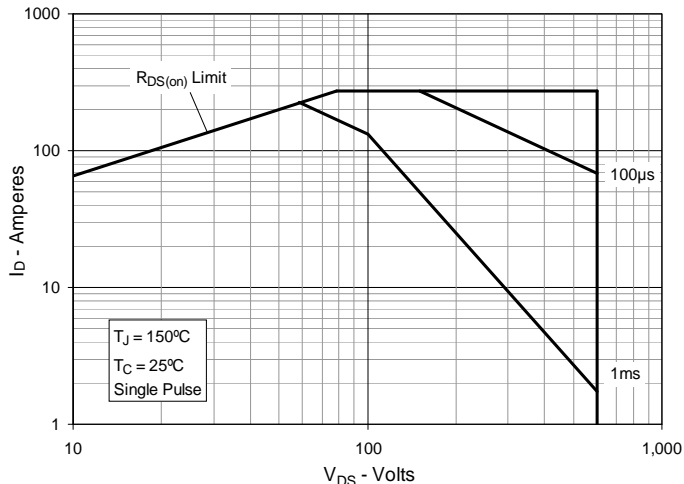
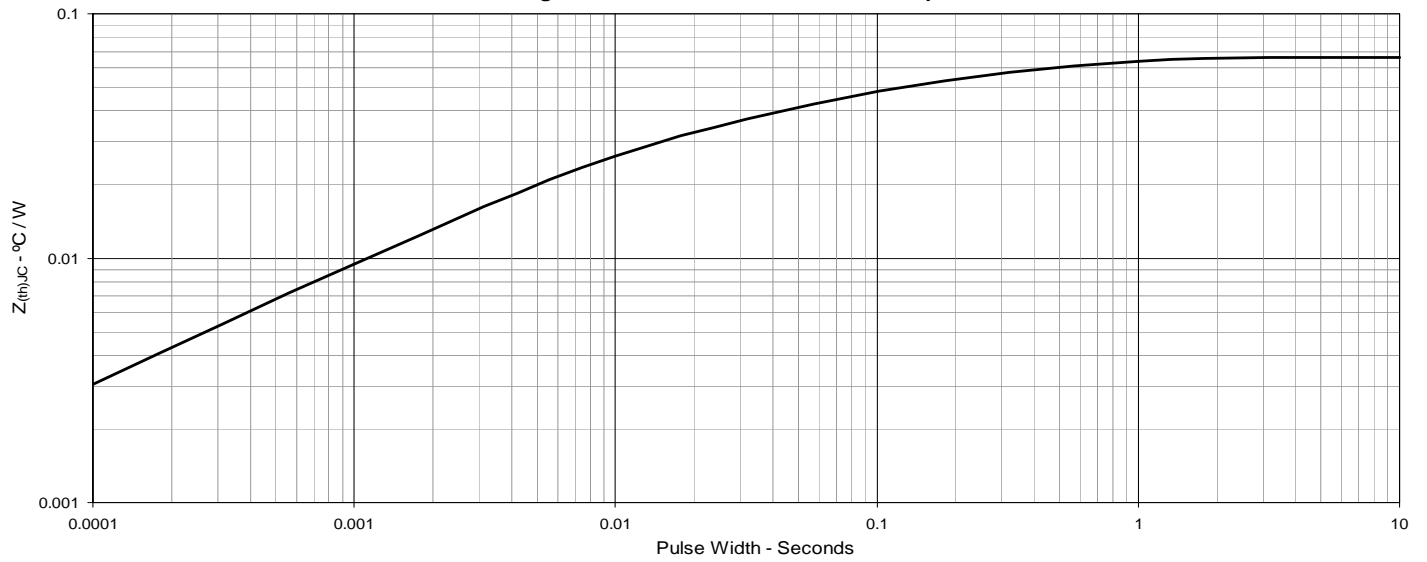

Fig. 13. Maximum Transient Thermal Impedance





Disclaimer Notice - Information furnished is believed to be accurate and reliable. However, users should independently evaluate the suitability of and test each product selected for their own applications. Littelfuse products are not designed for, and may not be used in, all applications. Read complete Disclaimer Notice at www.littelfuse.com/disclaimer-electronics.