

## HiPerFET™ Power MOSFETs

**IXFA 3N120**  
**IXFP 3N120**

**V<sub>DSS</sub> = 1200 V**  
**I<sub>D25</sub> = 3 A**  
**R<sub>DS(on)</sub> = 4.5 Ω**

N-Channel Enhancement Mode  
Avalanche Rated, Low Q<sub>g</sub>, High dv/dt

Preliminary Data Sheet

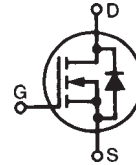

**t<sub>rr</sub> ≤ 300 ns**

Symbol	Test Conditions	Maximum Ratings	
V <sub>DSS</sub>	T <sub>J</sub> = 25°C to 150°C	1200	V
V <sub>DGR</sub>	T <sub>J</sub> = 25°C to 150°C; R <sub>GS</sub> = 1 MΩ	1200	V
V <sub>GS</sub>	Continuous	±20	V
V <sub>GSM</sub>	Transient	±30	V
I <sub>D25</sub>	T <sub>C</sub> = 25°C	3	A
I <sub>DM</sub>	T <sub>C</sub> = 25°C, pulse width limited by T <sub>JM</sub>	12	A
I <sub>AR</sub>	T <sub>C</sub> = 25°C	3	A
E <sub>AR</sub>	T <sub>C</sub> = 25°C	20	mJ
E <sub>AS</sub>		700	mJ
dv/dt	I <sub>S</sub> ≤ I <sub>DM</sub> ; di/dt ≤ 100 A/μs, V <sub>DD</sub> ≤ V <sub>DSS</sub> , T <sub>J</sub> ≤ 150°C, R <sub>G</sub> = 4.7 Ω	10	V/ns
P <sub>D</sub>	T <sub>C</sub> = 25°C	200	W
T <sub>J</sub>		-55 to +150	°C
T <sub>JM</sub>		150	°C
T <sub>stg</sub>		-55 to +150	°C
T <sub>L</sub>	1.6 mm (0.063 in) from case for 10 s	300	°C
M <sub>d</sub>	Mounting torque (TO-220)	1.13/10	Nm/lb.in.
Weight	TO-220	4	g
	TO-263	2	g

TO-220 (IXFP)

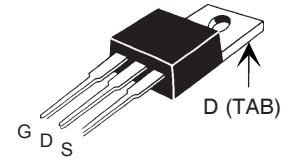

TO-263 (IXFA)

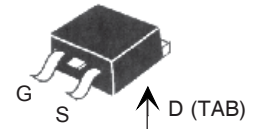

G = Gate      D = Drain  
S = Source    TAB = Drain

### Features

- Low gate charge and capacitances
  - easier to drive
  - faster switching
- International standard packages
- Low R<sub>DS(on)</sub>
- Rated for unclamped Inductive load Switching (UIS)
- Molding epoxies meet UL 94 V-0 flammability classification

### Advantages

- Easy to mount
- Space savings
- High power density

Symbol	Test Conditions	Characteristic Values (T <sub>J</sub> = 25°C, unless otherwise specified)		
		min.	typ.	max.
V <sub>DSS</sub>	V <sub>GS</sub> = 0 V, I <sub>D</sub> = 1 mA	1200		V
V <sub>GS(th)</sub>	V <sub>DS</sub> = V <sub>GS</sub> , I <sub>D</sub> = 1.5 mA	2.5		V
I <sub>GSS</sub>	V <sub>GS</sub> = ±20 V <sub>DC</sub> , V <sub>DS</sub> = 0			±100 nA
I <sub>DSS</sub>	V <sub>DS</sub> = V <sub>DSS</sub> , V <sub>GS</sub> = 0 V		T <sub>J</sub> = 25°C T <sub>J</sub> = 125°C	50 μA 2 mA
R <sub>DS(on)</sub>	V <sub>GS</sub> = 10 V, I <sub>D</sub> = 0.5 I <sub>D25</sub> Pulse test, t ≤ 300 μs, duty cycle d ≤ 2 %			4.5 Ω

Symbol	Test Conditions	Characteristic Values		
		(T <sub>J</sub> = 25°C, unless otherwise specified)		
		min.	typ.	max.
g <sub>fs</sub>	V <sub>DS</sub> = 20 V; I <sub>D</sub> = 0.5 • I <sub>D25</sub> , pulse test	1.5	2.5	S
C <sub>iss</sub>	V <sub>GS</sub> = 0 V, V <sub>DS</sub> = 25 V, f = 1 MHz		1050	pF
C <sub>oss</sub>			100	pF
C <sub>rss</sub>			25	pF
t <sub>d(on)</sub>	V <sub>GS</sub> = 10 V, V <sub>DS</sub> = 0.5 • V <sub>DSS</sub> , I <sub>D</sub> = 0.5 • I <sub>D25</sub> R <sub>G</sub> = 4.7 Ω (External),		17	ns
t <sub>r</sub>			15	ns
t <sub>d(off)</sub>			32	ns
t <sub>f</sub>			18	ns
Q <sub>g(on)</sub>	V <sub>GS</sub> = 10 V, V <sub>DS</sub> = 0.5 • V <sub>DSS</sub> , I <sub>D</sub> = 0.5 • I <sub>D25</sub>		39	nC
Q <sub>gs</sub>			9	nC
Q <sub>gd</sub>			22	nC
R <sub>thJC</sub>	(TO-220)			0.62 KW
R <sub>thCK</sub>			0.25	KW

### Source-Drain Diode

Symbol	Test Conditions	Characteristic Values		
		(T <sub>J</sub> = 25°C, unless otherwise specified)		
		min.	typ.	max.
I <sub>S</sub>	V <sub>GS</sub> = 0 V			3 A
I <sub>SM</sub>	Repetitive; pulse width limited by T <sub>JM</sub>			12 A
V <sub>SD</sub>	I <sub>F</sub> = I <sub>S</sub> , V <sub>GS</sub> = 0 V, Pulse test, t ≤ 300 μs, duty cycle d ≤ 2 %			1.5 V
t <sub>rr</sub>	I <sub>F</sub> = I <sub>S</sub> , -di/dt = 100 A/μs, V <sub>R</sub> = 100 V			300 ns
Q <sub>RM</sub>			0.4	μC
I <sub>RM</sub>			1.2	A

### TO-220 (IXFP) Outline

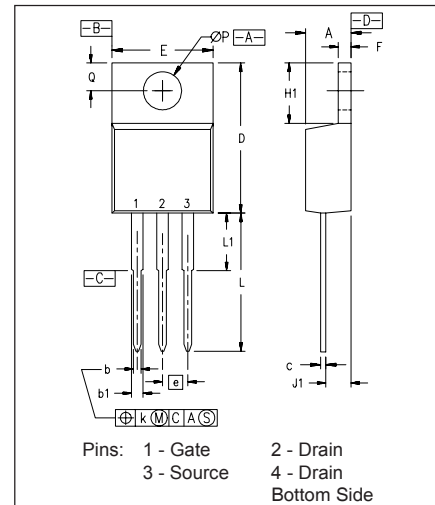

SYM	INCHES		MILLIMETERS	
	MIN	MAX	MIN	MAX
A	.170	.190	4.32	4.83
b	.025	.040	0.64	1.02
b1	.045	.065	1.15	1.65
c	.014	.022	0.35	0.56
D	.580	.630	14.73	16.00
E	.390	.420	9.91	10.66
e	.100 BSC		2.54 BSC	
F	.045	.055	1.14	1.40
H1	.230	.270	5.85	6.85
J1	.090	.110	2.29	2.79
k	0	.015	0	0.38
L	.500	.550	12.70	13.97
L1	.110	.230	2.79	5.84
ØP	.139	.161	3.53	4.08
Q	.100	.125	2.54	3.18

NOTE: This drawing will meet all dimensions requirement of JEDEC outline TO-220 AB.

### TO-263 (IXFA) Outline

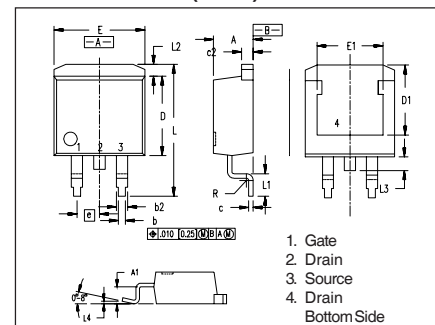

Dim.	Millimeter		Inches	
	Min.	Max.	Min.	Max.
A	4.06	4.83	.160	.190
A1	2.03	2.79	.080	.110
b	0.51	0.99	.020	.039
b2	1.14	1.40	.045	.055
c	0.46	0.74	.018	.029
c2	1.14	1.40	.045	.055
D	8.64	9.65	.340	.380
D1	7.11	8.13	.280	.320
E	9.65	10.29	.380	.405
E1	6.86	8.13	.270	.320
e	2.54	BSC	.100	BSC
L	14.61	15.88	.575	.625
L1	2.29	2.79	.090	.110
L2	1.02	1.40	.040	.055
L3	1.27	1.78	.050	.070
L4	0	0.38	0	.015
R	0.46	0.74	.018	.029

IXYS reserves the right to change limits, test conditions, and dimensions.

IXYS MOSFETs and IGBTs are covered by one or more of the following U.S. patents:	4,835,592	4,931,844	5,049,961	5,237,481	6,162,665	6,404,065B1	6,683,344	6,727,585
	4,850,072	5,017,508	5,063,307	5,381,025	6,259,123B1	6,534,343	6,710,405B2	
	4,881,106	5,034,796	5,187,117	5,486,715	6,306,728 B1	6,583,505	6,710,463	

**Fig. 1. Output Characteristics**  
@ 25 Deg. C

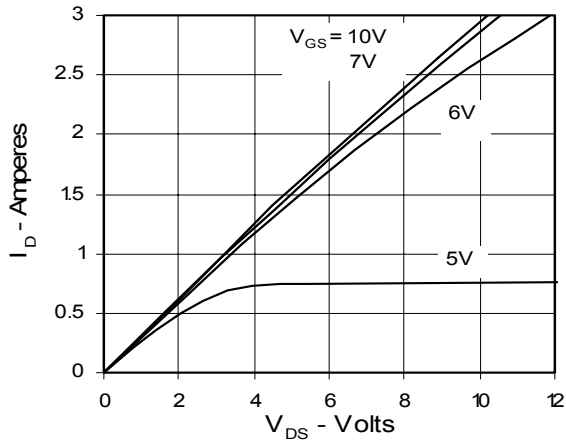

**Fig. 2. Extended Output Characteristics**  
@ 25 deg. C

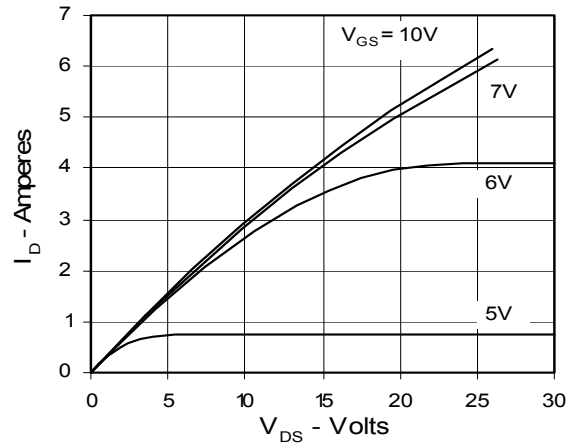

**Fig. 3. Output Characteristics**  
@ 125 Deg. C

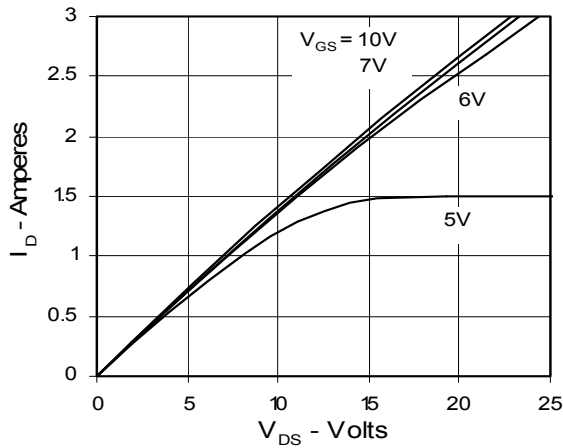

**Fig. 4.  $R_{DS(on)}$  Normalized to  $I_{D25}$  Value vs. Junction Temperature**

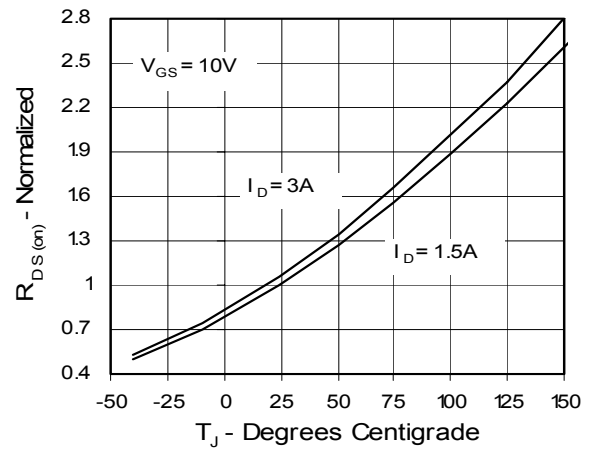

**Fig. 5.  $R_{DS(on)}$  Normalized to  $I_{D25}$  Value vs.  $I_D$**

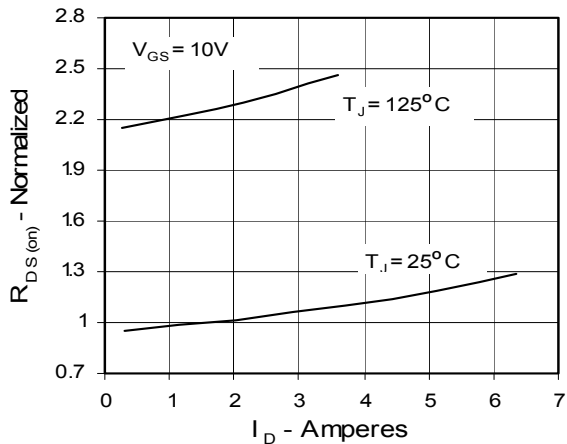

**Fig. 6. Drain Current vs. Case Temperature**

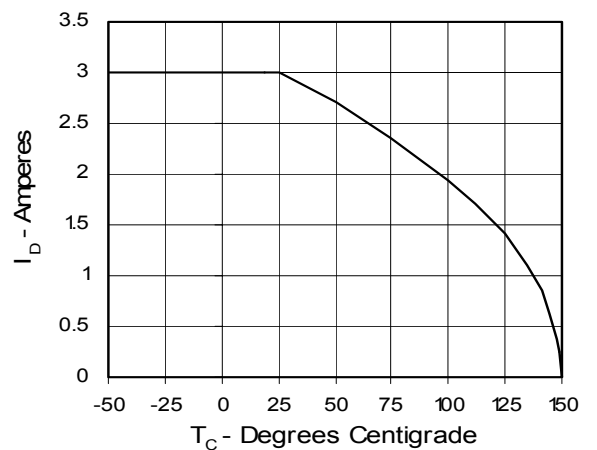

**Fig. 7. Input Admittance**

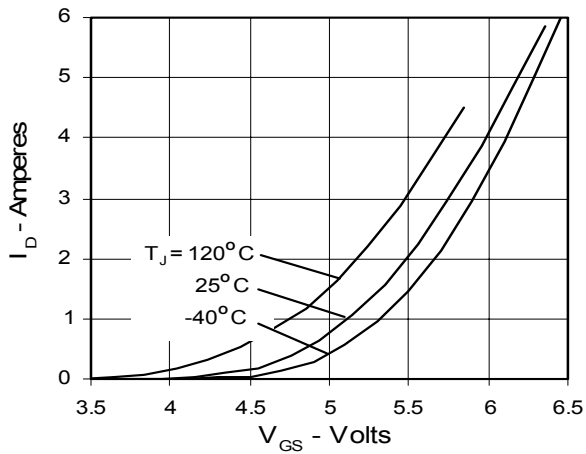

**Fig. 8. Transconductance**

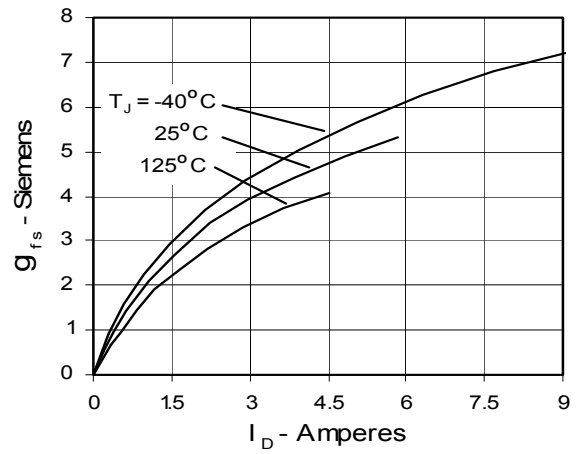

**Fig. 9. Source Current vs. Source-To-Drain Voltage**

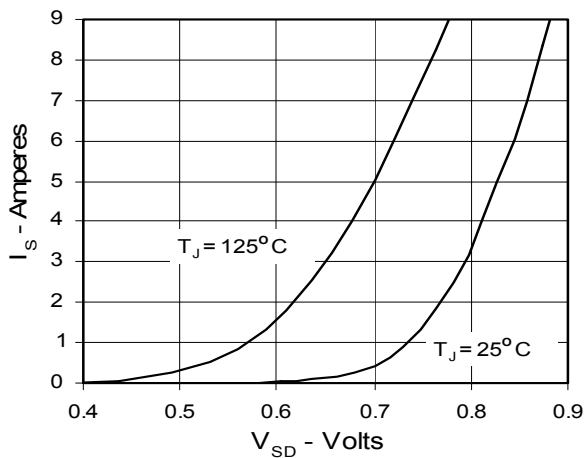

**Fig. 10. Gate Charge**

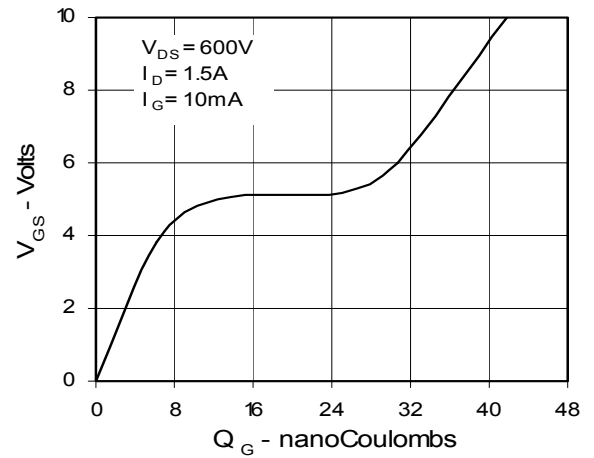

**Fig. 11. Capacitance**

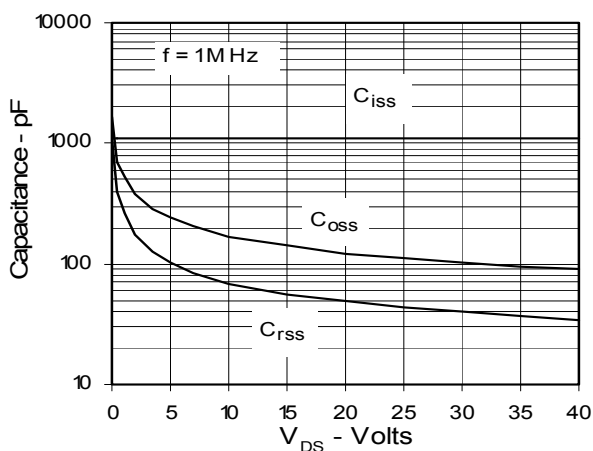

**Fig. 12. Maximum Transient Thermal Resistance**

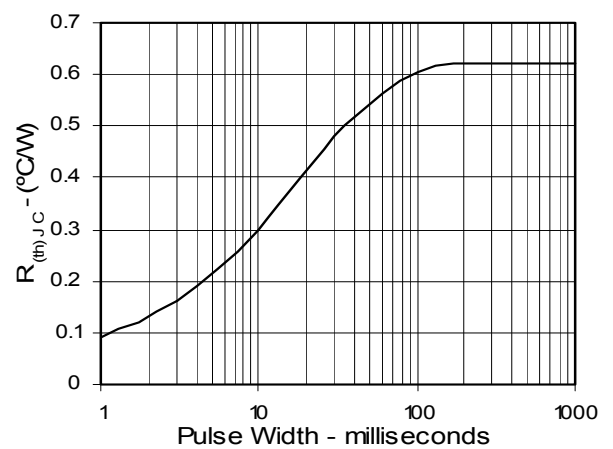



---

Disclaimer Notice - Information furnished is believed to be accurate and reliable. However, users should independently evaluate the suitability of and test each product selected for their own applications. Littelfuse products are not designed for, and may not be used in, all applications. Read complete Disclaimer Notice at [www.littelfuse.com/disclaimer-electronics](http://www.littelfuse.com/disclaimer-electronics).