

# PolarHV™ HiPerFET Power MOSFET

**IXFK 80N50P**  
**IXFX 80N50P**

$V_{DSS} = 500 \text{ V}$   
 $I_{D25} = 80 \text{ A}$   
 $R_{DS(on)} \leq 65 \text{ m}\Omega$   
 $t_{rr} \leq 200 \text{ ns}$

N-Channel Enhancement Mode  
Avalanche Rated  
Fast Intrinsic Diode



Symbol	Test Conditions	Maximum Ratings	
$V_{DSS}$	$T_J = 25^\circ\text{C to } 150^\circ\text{C}$	500	V
$V_{DGR}$	$T_J = 25^\circ\text{C to } 150^\circ\text{C}; R_{GS} = 1 \text{ M}\Omega$	500	V
$V_{GSM}$	Transient	$\pm 40$	V
$V_{GSM}$	Continuous	$\pm 30$	V
$I_{D25}$	$T_C = 25^\circ\text{C}$	80	A
$I_L$	Lead Current Limit, RMS	75	A
$I_{DM}$	$T_C = 25^\circ\text{C}$ , pulse width limited by $T_{JM}$	200	A
$I_{AR}$	$T_C = 25^\circ\text{C}$	80	A
$E_{AR}$	$T_C = 25^\circ\text{C}$	80	mJ
$E_{AS}$	$T_C = 25^\circ\text{C}$	3.5	J
$dv/dt$	$I_S \leq I_{DM}$ , $di/dt \leq 100 \text{ A}/\mu\text{s}$ , $V_{DD} \leq V_{DSS}$ , $T_J \leq 150^\circ\text{C}$ , $R_G = 2 \Omega$	20	V/ns
$P_D$	$T_C = 25^\circ\text{C}$	1040	W
$T_J$		-55 ... +150	$^\circ\text{C}$
$T_{JM}$		150	$^\circ\text{C}$
$T_{stg}$		-55 ... +150	$^\circ\text{C}$
$T_L$	1.6 mm (0.062 in.) from case for 10 s	300	$^\circ\text{C}$
$T_{SOLD}$	Plastic body for 10 seconds	260	$^\circ\text{C}$
$F_C$	Mounting force (PLUS247)	20..120/4.5..25	N/lb
$M_d$	Mounting torque (TO-264)	1.13/10	Nm/lb.in.
Weight	TO-264	10	g
	PLUS247	6	g

TO-264 (IXFK)

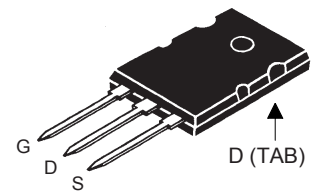

PLUS247 (IXFX)

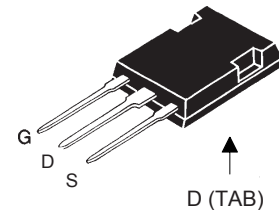

G = Gate      S = Source  
D = Drain      Tab = Collector

## Features

- † International standard package
- † Unclamped Inductive Switching (UIS) rated
- † Low package inductance
- easy to drive and to protect

## Advantages

- † Easy to mount
- † Space savings
- † High power density

Symbol	Test Conditions ( $T_J = 25^\circ\text{C}$ unless otherwise specified)	Characteristic Values		
		Min.	Typ.	Max.
$BV_{DSS}$	$V_{GS} = 0 \text{ V}$ , $I_D = 500 \mu\text{A}$	500		V
$V_{GS(th)}$	$V_{DS} = V_{GS}$ , $I_D = 8 \text{ mA}$	3.0		5.0 V
$I_{GSS}$	$V_{GS} = \pm 30 \text{ V}_{DC}$ , $V_{DS} = 0$			$\pm 200 \text{ nA}$
$I_{DSS}$	$V_{DS} = V_{DSS}$ $V_{GS} = 0 \text{ V}$ $T_J = 125^\circ\text{C}$			25 $\mu\text{A}$
				2 mA
$R_{DS(on)}$	$V_{GS} = 10 \text{ V}$ , $I_D = 0.5 I_{D25}$			65 m $\Omega$

Symbol	Test Conditions	Characteristic Values ( $T_J = 25^\circ\text{C}$ unless otherwise specified)		
		Min.	Typ.	Max.
$g_{fs}$	$V_{DS} = 20\text{ V}; I_D = 0.5 I_{D25}$ , Note 1	45	70	S
$C_{iss}$	$V_{GS} = 0\text{ V}, V_{DS} = 25\text{ V}, f = 1\text{ MHz}$		12.7	nF
$C_{oss}$			1280	pF
$C_{rss}$			120	pF
$t_{d(on)}$	$V_{GS} = 10\text{ V}, V_{DS} = 0.5 V_{DSS}, I_D = 0.5 I_{D25}$ $R_G = 1\ \Omega$ (External)		25	ns
$t_r$			27	ns
$t_{d(off)}$			70	ns
$t_f$			16	ns
$Q_{g(on)}$	$V_{GS} = 10\text{ V}, V_{DS} = 0.5 V_{DSS}, I_D = 0.5 I_{D25}$		197	nC
$Q_{gs}$			70	nC
$Q_{gd}$			64	nC
$R_{thJC}$				$0.12^\circ\text{C/W}$
$R_{thCS}$		0.15		$^\circ\text{C/W}$

Symbol	Test Conditions	Characteristic Values ( $T_J = 25^\circ\text{C}$ unless otherwise specified)		
		Min.	Typ.	Max.
$I_S$	$V_{GS} = 0\text{ V}$			80 A
$I_{SM}$	Repetitive			200 A
$V_{SD}$	$I_F = I_S, V_{GS} = 0\text{ V}$			1.5 V
$t_{rr}$	$I_F = 25\text{ A}, -di/dt = 100\text{ A}/\mu\text{s}$			200 ns
$Q_{RM}$		$V_R = 100\text{ V}, V_{GS} = 0\text{ V}$		0.6
$I_{RM}$				6

**Notes:**

1. Pulse test,  $t \leq 300\ \mu\text{s}$ , duty cycle  $d \leq 2\%$

**PLUS 247™ (IXFX) Outline**

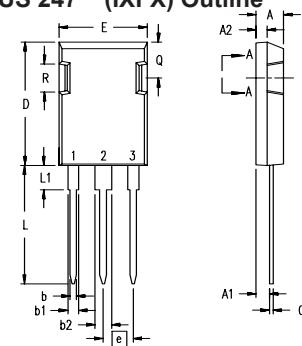

- Terminals: 1 - Gate  
2 - Drain (Collector)  
3 - Source (Emitter)  
4 - Drain (Collector)

Dim.	Millimeter		Inches	
	Min.	Max.	Min.	Max.
A	4.83	5.21	.190	.205
A <sub>1</sub>	2.29	2.54	.090	.100
A <sub>2</sub>	1.91	2.16	.075	.085
b	1.14	1.40	.045	.055
b <sub>1</sub>	1.91	2.13	.075	.084
b <sub>2</sub>	2.92	3.12	.115	.123
C	0.61	0.80	.024	.031
D	20.80	21.34	.819	.840
E	15.75	16.13	.620	.635
e	5.45 BSC		.215 BSC	
L	19.81	20.32	.780	.800
L1	3.81	4.32	.150	.170
Q	5.59	6.20	.220	0.244
R	4.32	4.83	.170	.190

**TO-264 (IXFK) Outline**

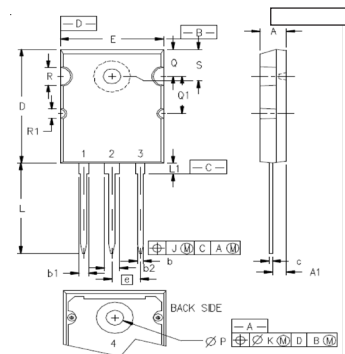

- 1 - GATE  
2, 4 - DRAIN (COLLECTOR)  
3 - SOURCE (EMITTER)

SYM	INCHES		MILLIMETERS	
	MIN	MAX	MIN	MAX
A	.185	.209	4.70	5.31
A1	.102	.118	2.59	3.00
b	.037	.055	0.94	1.40
b1	.087	.102	2.21	2.59
b2	.110	.126	2.79	3.20
c	.017	.029	0.43	0.74
D	1.007	1.047	25.58	26.59
E	.760	.799	19.30	20.29
e	.215BSC		5.46 BSC	
J	.000	.010	0.00	0.25
K	.000	.010	0.00	0.25
L	.779	.842	19.79	21.39
L1	.087	.102	2.21	2.59
ØP	.122	.138	3.10	3.51
Q	.240	.256	6.10	6.50
Q1	.330	.346	8.38	8.79
ØR	.155	.187	3.94	4.75
ØR1	.085	.093	2.16	2.36
S	.243	.253	6.17	6.43

IXYS reserves the right to change limits, test conditions, and dimensions.

IXYS MOSFETs and IGBTs are covered by 4,835,592 4,931,844 5,049,961 5,237,481 6,162,665 6,404,065 B1 6,683,344 6,727,585  
one or more of the following U.S. patents: 4,850,072 5,017,508 5,063,307 5,381,025 6,259,123 B1 6,534,343 6,710,405B2 6,759,692  
4,881,106 5,034,796 5,187,117 5,486,715 6,306,728 B1 6,583,505 6,710,463 6,771,478 B2

**Fig. 1. Output Characteristics**  
**@ 25°C**

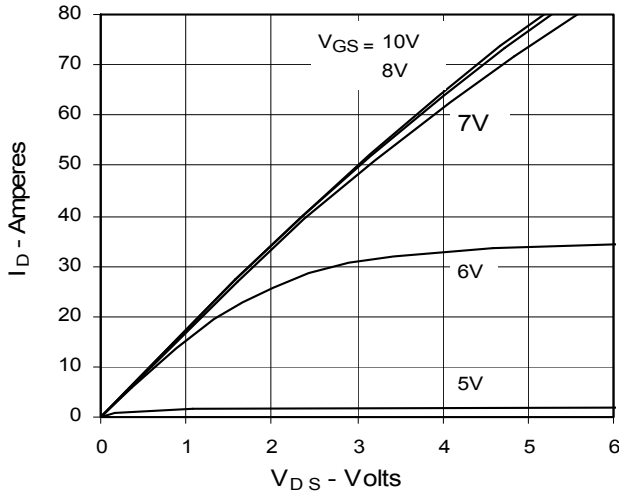

**Fig. 2. Extended Output Characteristics**  
**@ 25°C**

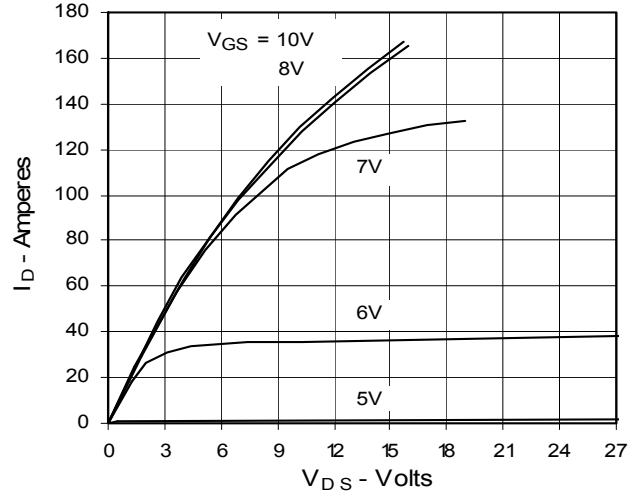

**Fig. 3. Output Characteristics**  
**@ 125°C**

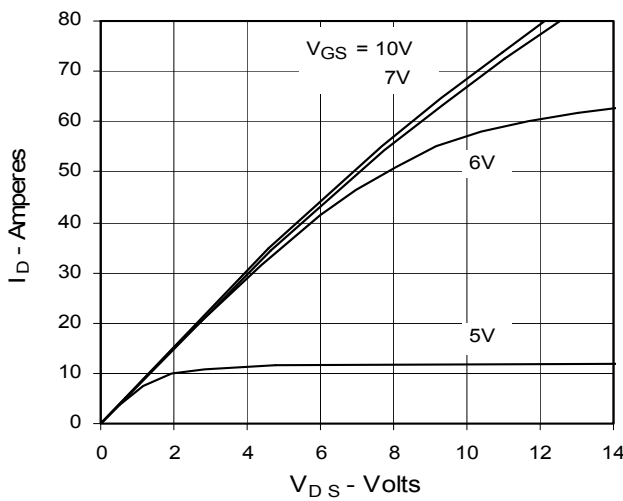

**Fig. 4.  $R_{DS(on)}$  Normalized to 0.5  $I_{D25}$  Value vs. Junction Temperature**



**Fig. 5.  $R_{DS(on)}$  Normalized to 0.5  $I_{D25}$  Value vs.  $I_D$**

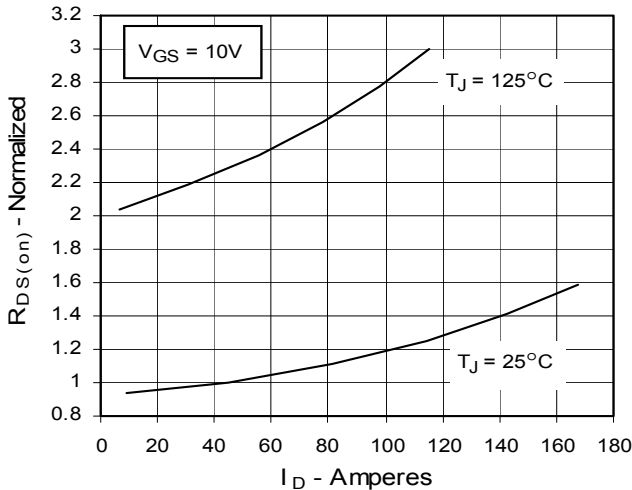

**Fig. 6. Drain Current vs. Case Temperature**

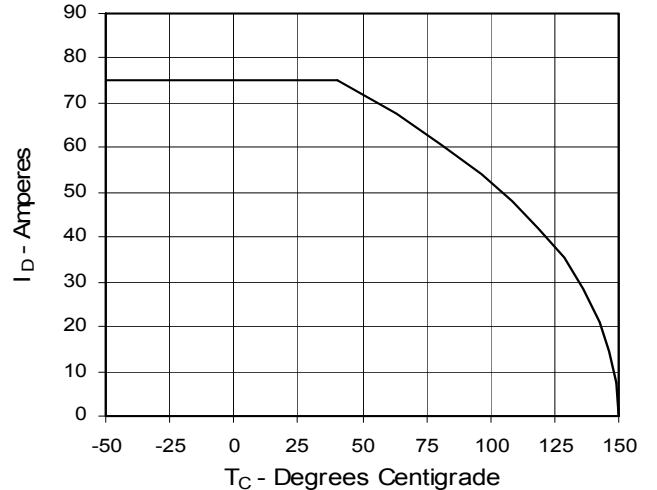

**Fig. 7. Input Admittance**

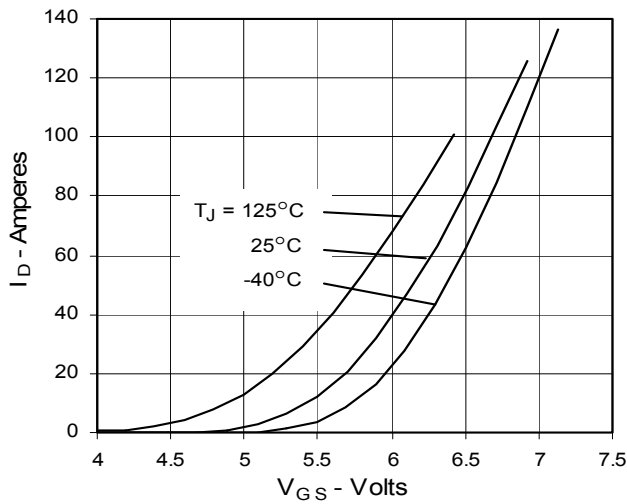

**Fig. 8. Transconductance**

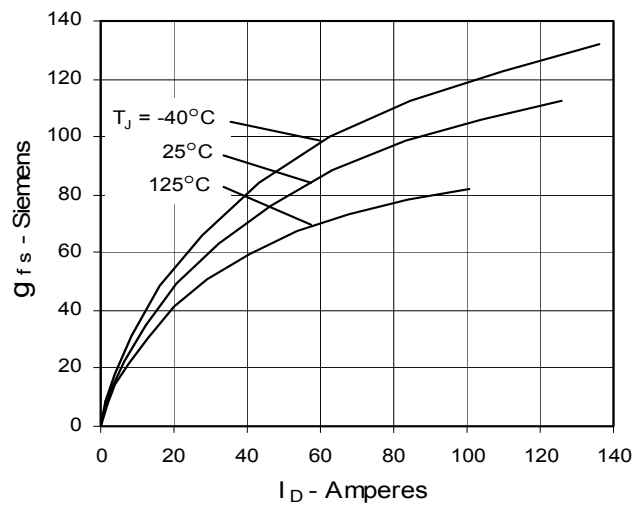

**Fig. 9. Source Current vs. Source-To-Drain Voltage**

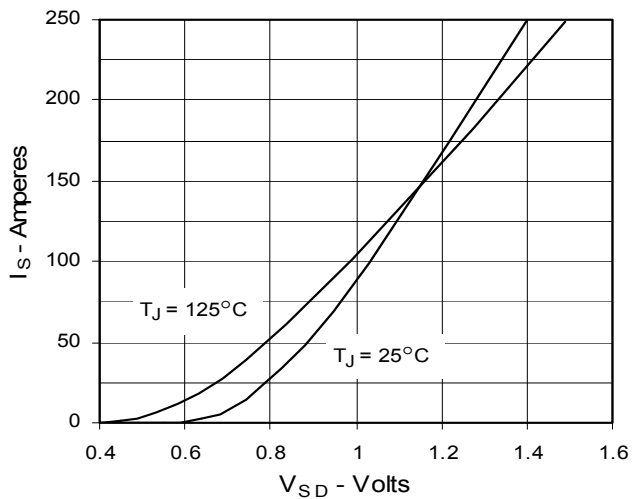

**Fig. 10. Gate Charge**

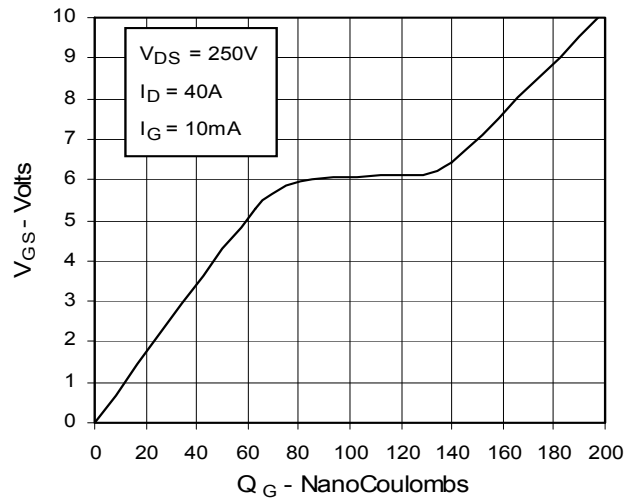

**Fig. 11. Capacitance**

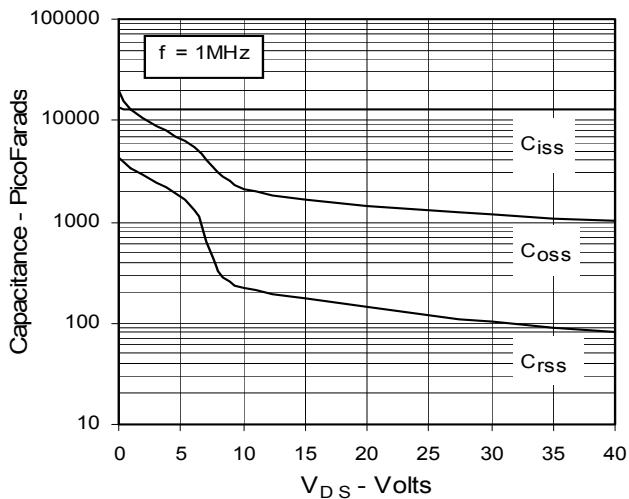

**Fig. 12. Forward-Bias Safe Operating Area**

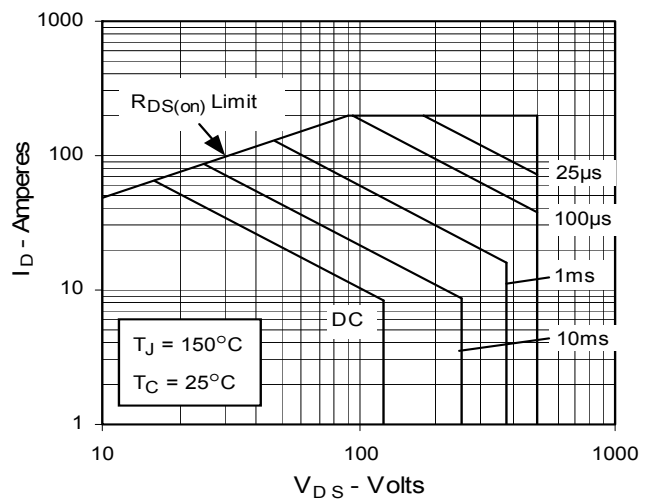
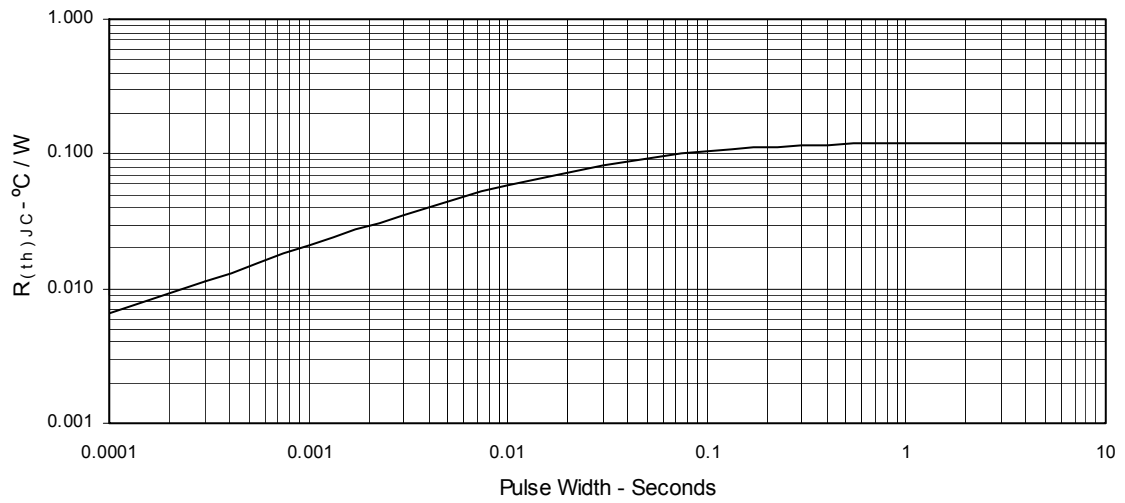

Fig. 13. Maximum Transient Thermal Resistance





---

Disclaimer Notice - Information furnished is believed to be accurate and reliable. However, users should independently evaluate the suitability of and test each product selected for their own applications. Littelfuse products are not designed for, and may not be used in, all applications. Read complete Disclaimer Notice at [www.littelfuse.com/disclaimer-electronics](http://www.littelfuse.com/disclaimer-electronics).