

Polar™ HiPerFET™ Power MOSFET

IXFA7N80P IXFP7N80P

N-Channel Enhancement Mode
Avalanche Rated
Fast Intrinsic Rectifier

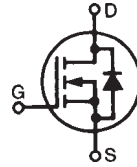

$V_{DSS} = 800V$
 $I_{D25} = 7A$
 $R_{DS(on)} \leq 1.44\Omega$
 $t_{rr} \leq 250ns$

Symbol	Test Conditions	Maximum Ratings	
V_{DSS}	$T_J = 25^\circ C$ to $150^\circ C$	800	V
V_{DGR}	$T_J = 25^\circ C$ to $150^\circ C$, $R_{GS} = 1M\Omega$	800	V
V_{GSS}	Continuous	± 30	V
V_{GSM}	Transient	± 40	V
I_{D25}	$T_C = 25^\circ C$	7	A
I_{DM}	$T_C = 25^\circ C$, Pulse Width Limited by T_{JM}	18	A
I_A	$T_C = 25^\circ C$	4	A
E_{AS}	$T_C = 25^\circ C$	300	mJ
dv/dt	$I_S \leq I_{DM}$, $V_{DD} \leq V_{DSS}$, $T_J \leq 150^\circ C$	10	V/ns
P_D	$T_C = 25^\circ C$	200	W
T_J		-55 ... +150	$^\circ C$
T_{JM}		150	$^\circ C$
T_{stg}		-55 ... +150	$^\circ C$
T_L	Maximum Lead Temperature for Soldering	300	$^\circ C$
T_{SOLD}	1.6 mm (0.062in.) from Case for 10s	260	$^\circ C$
F_C	Mounting Force (TO-263)	10..65 / 2.2..14.6	N/lb
M_d	Mounting Torque (TO-220)	1.13 / 10	Nm/lb.in
Weight	TO-263	2.5	g
	TO-220	3.0	g

TO-263
(IXFA)

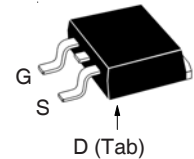

TO-220
(IXFP)

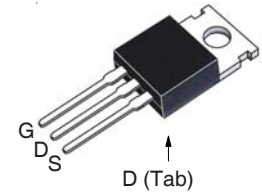

G = Gate D = Drain
S = Source Tab = Drain

Features

- International Standard Packages
- Dynamic dv/dt Rating
- Avalanche Rated
- Fast Intrinsic Rectifier
- Low Q_g

Advantages

- Easy to Mount
- Space Savings

Applications

- DC-DC Converters
- Battery Chargers
- Switch-Mode and Resonant-Mode Power Supplies
- Uninterrupted Power Supplies
- AC Motor Drives
- High Speed Power Switching Applications

Symbol	Test Conditions ($T_J = 25^\circ C$ Unless Otherwise Specified)	Characteristic Values		
		Min.	Typ.	Max.
BV_{DSS}	$V_{GS} = 0V$, $I_D = 250\mu A$	800		V
$V_{GS(th)}$	$V_{DS} = V_{GS}$, $I_D = 1mA$	3.0		V
I_{GSS}	$V_{GS} = \pm 30V$, $V_{DS} = 0V$			± 100 nA
I_{DSS}	$V_{DS} = V_{DSS}$, $V_{GS} = 0V$ $T_J = 125^\circ C$			25 μA
				500 μA
$R_{DS(on)}$	$V_{GS} = 10V$, $I_D = 0.5 \cdot I_{D25}$, Notes 1, 2			1.44 Ω

Symbol	Test Conditions ($T_J = 25^\circ\text{C}$, Unless Otherwise Specified)	Characteristic Values		
		Min.	Typ.	Max.
g_{fs}	$V_{DS} = 20\text{V}$, $I_D = 0.5 \cdot I_{D25}$, Note 1	5.0	9.5	S
C_{iss}	$V_{GS} = 0\text{V}$, $V_{DS} = 25\text{V}$, $f = 1\text{MHz}$		1800	pF
C_{oss}			128	pF
C_{rss}			9.5	pF
$t_{d(on)}$	Resistive Switching Times $V_{GS} = 10\text{V}$, $V_{DS} = 0.5 \cdot V_{DSS}$, $I_D = 0.5 \cdot I_{D25}$ $R_G = 10\Omega$ (External)		28	ns
t_r			32	ns
$t_{d(off)}$			55	ns
t_f			24	ns
$Q_{g(on)}$	$V_{GS} = 10\text{V}$, $V_{DS} = 0.5 \cdot V_{DSS}$, $I_D = 0.5 \cdot I_{D25}$		32	nC
Q_{gs}			12	nC
Q_{gd}			9	nC
R_{thJC}	TO-220		0.50	0.62°C/W
R_{thCH}				$^\circ\text{C/W}$

Source-Drain Diode

Symbol	Test Conditions ($T_J = 25^\circ\text{C}$, Unless Otherwise Specified)	Characteristic Values		
		Min.	Typ.	Max.
I_S	$V_{GS} = 0\text{V}$			7 A
I_{SM}	Repetitive, Pulse Width Limited by T_{JM}			28 A
V_{SD}	$I_F = I_S$, $V_{GS} = 0\text{V}$, Note 1			1.5 V
t_{rr}	$I_F = 7\text{A}$, $V_{GS} = 0\text{V}$ $-di/dt = 100\text{A}/\mu\text{s}$ $V_R = 100\text{V}$		3	250 ns
I_{RM}				A
Q_{RM}				300 nC

- Notes: 1. Pulse test, $t \leq 300\mu\text{s}$, duty cycle, $d \leq 2\%$.
2. On through-hole packages, $R_{DS(on)}$ Kelvin test contact location must be 5mm or less from the package body.

TO-263 Outline

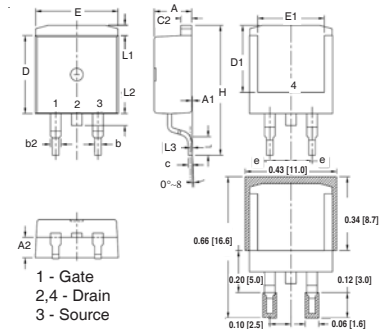

SYM	INCHES		MILLIMETER	
	MIN	MAX	MIN	MAX
A	.170	.185	4.30	4.70
A1	.000	.008	0.00	0.20
A2	.091	.098	2.30	2.50
b	.028	.035	0.70	0.90
b2	.046	.060	1.18	1.52
C	.018	.024	0.45	0.60
C2	.049	.060	1.25	1.52
D	.340	.370	8.63	9.40
D1	.300	.327	7.62	8.30
E	.380	.410	9.65	10.41
E1	.270	.330	6.86	8.38
e	.100 BSC		2.54 BSC	
H	.580	.620	14.73	15.75
L	.075	.105	1.91	2.67
L1	.039	.060	1.00	1.52
L2	—	.070	—	1.77
L3	.010 BSC		0.254 BSC	

TO-220 Outline

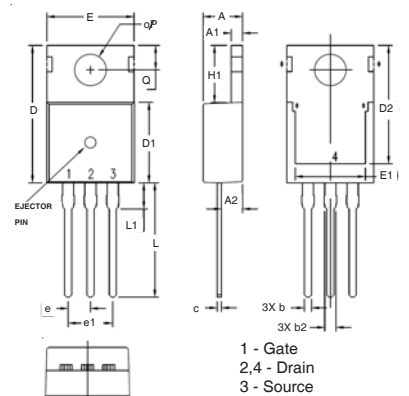

SYM	INCHES		MILLIMETERS	
	MIN	MAX	MIN	MAX
A	.169	.185	4.30	4.70
A1	.047	.055	1.20	1.40
A2	.079	.106	2.00	2.70
b	.024	.039	0.60	1.00
b2	.045	.057	1.15	1.45
c	.014	.026	0.35	0.65
D	.587	.626	14.90	15.90
D1	.335	.370	8.50	9.40
(D2)	.500	.531	12.70	13.50
E	.382	.406	9.70	10.30
(E1)	.283	.323	7.20	8.20
e	.100 BSC		2.54 BSC	
e1	.200 BSC		5.08 BSC	
H1	.244	.268	6.20	6.80
L	.492	.547	12.50	13.90
L1	.110	.154	2.80	3.90
∅P	.134	.150	3.40	3.80
Q	.106	.126	2.70	3.20

IXYS Reserves the Right to Change Limits, Test Conditions, and Dimensions.

IXYS MOSFETs and IGBTs are covered by one or more of the following U.S. patents:	4,835,592	4,931,844	5,049,961	5,237,481	6,162,665	6,404,065 B1	6,683,344	6,727,585	7,005,734 B2	7,157,338B2
	4,850,072	5,017,508	5,063,307	5,381,025	6,259,123 B1	6,534,343	6,710,405 B2	6,759,692	7,063,975 B2	
	4,881,106	5,034,796	5,187,117	5,486,715	6,306,728 B1	6,583,505	6,710,463	6,771,478 B2	7,071,537	

Fig. 1. Output Characteristics @ $T_J = 25^\circ\text{C}$

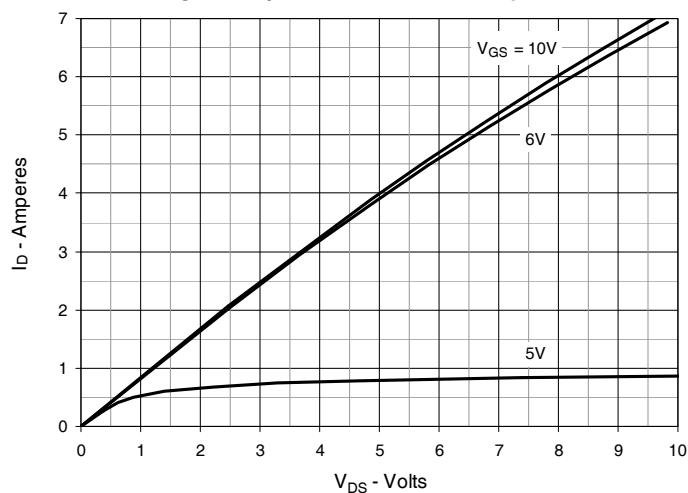

Fig. 2. Extended Output Characteristics @ $T_J = 25^\circ\text{C}$

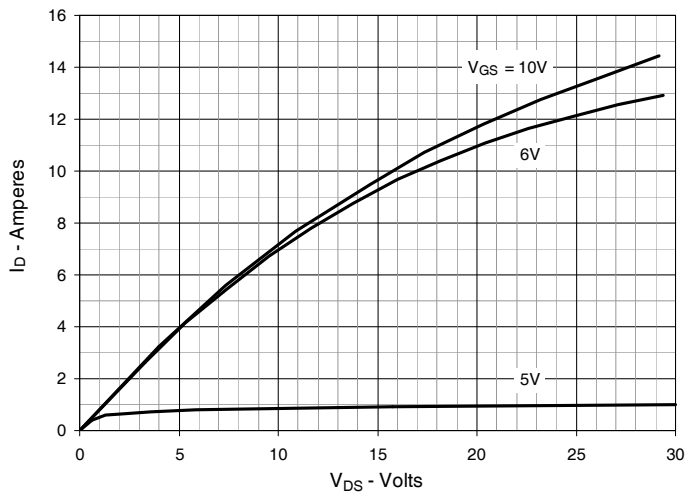

Fig. 3. Output Characteristics @ $T_J = 125^\circ\text{C}$

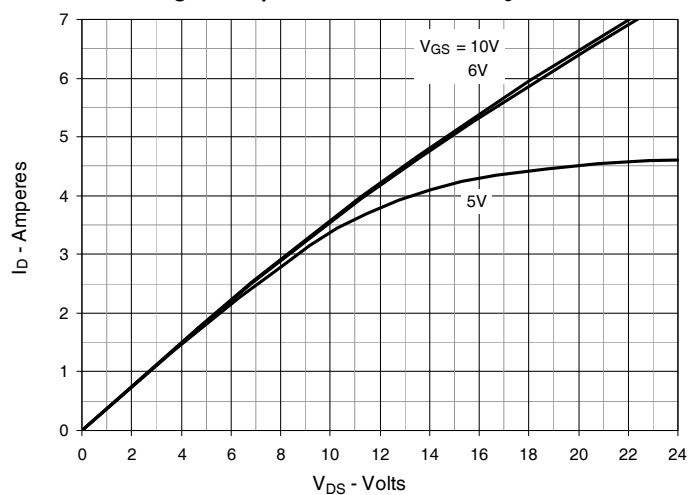

Fig. 4. $R_{DS(on)}$ Normalized to $I_D = 3.5A$ Value vs. Junction Temperature

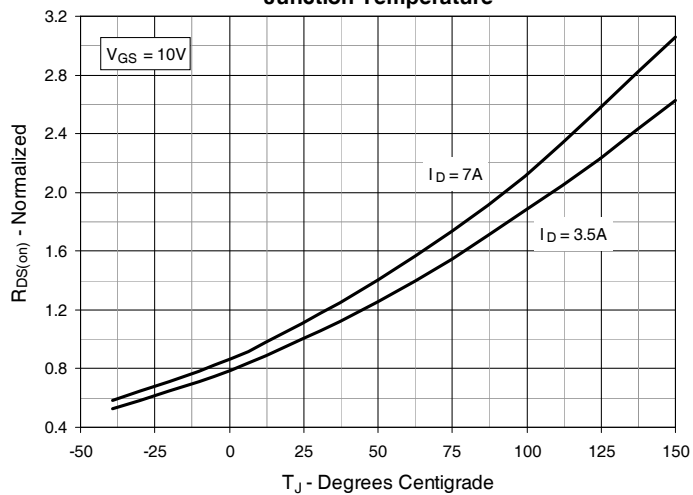

Fig. 5. $R_{DS(on)}$ Normalized to $I_D = 3.5A$ Value vs. Drain Current

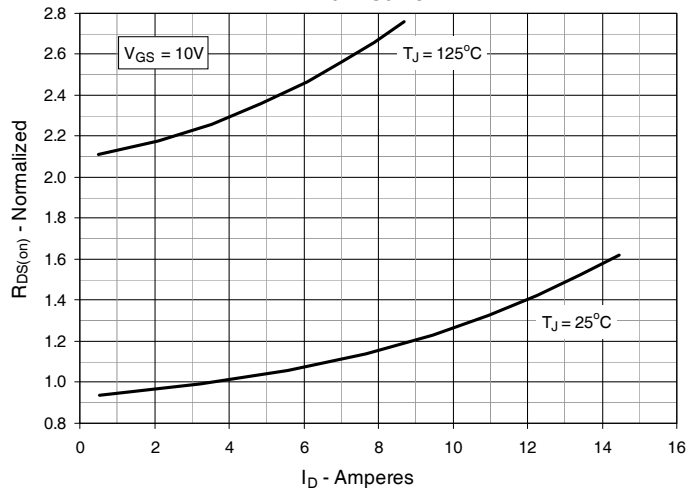

Fig. 6. Maximum Drain Current vs. Case Temperature

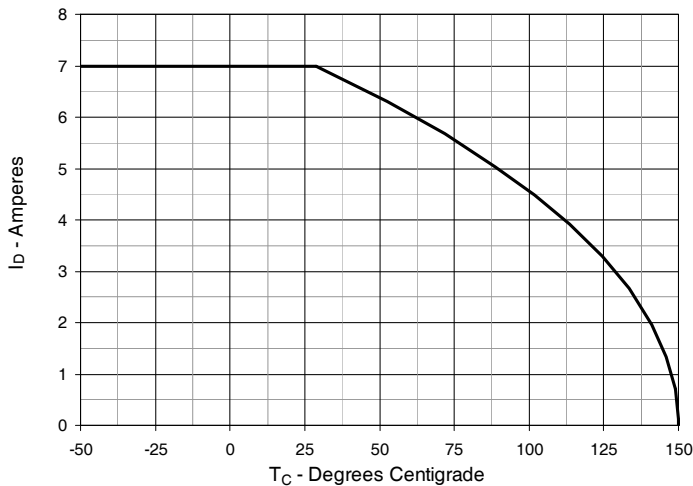

Fig. 7. Input Admittance

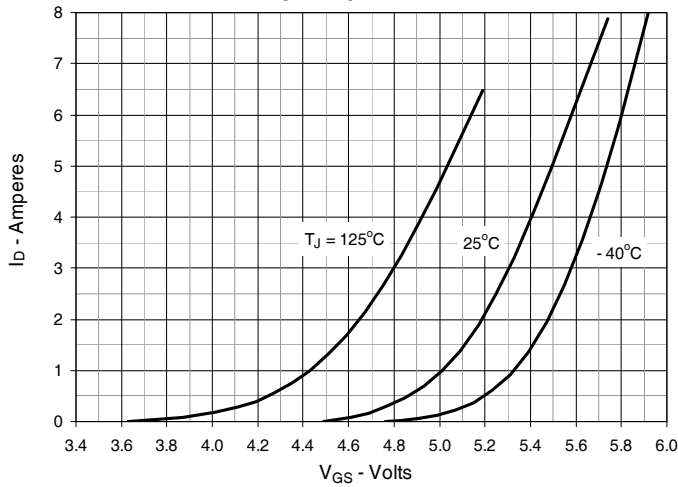

Fig. 8. Transconductance

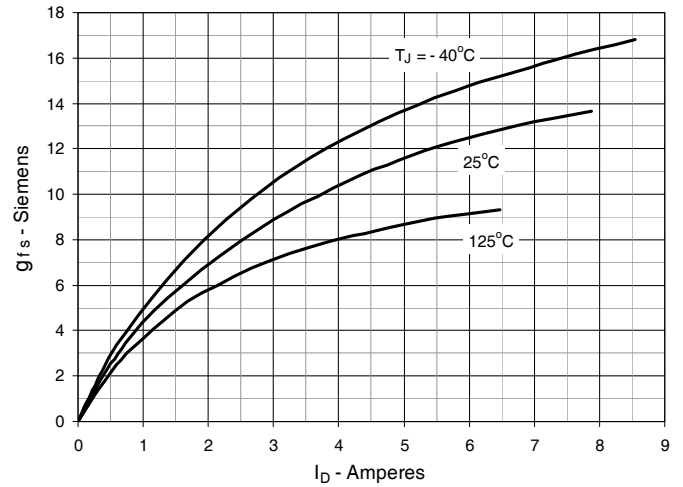

Fig. 9. Forward Voltage Drop of Intrinsic Diode

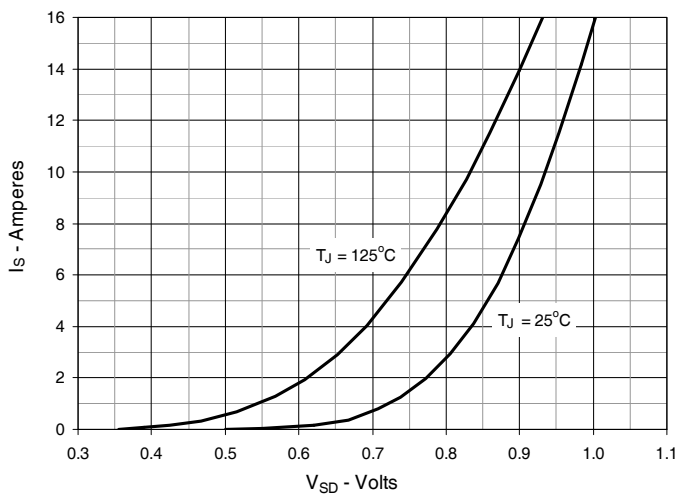

Fig. 10. Gate Charge

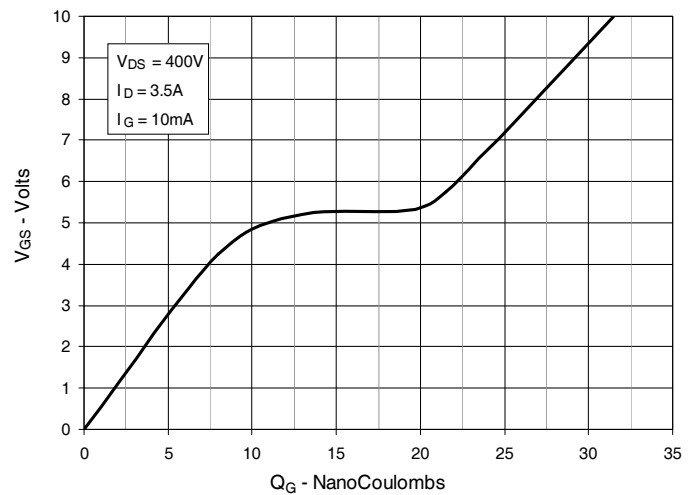

Fig. 11. Capacitance

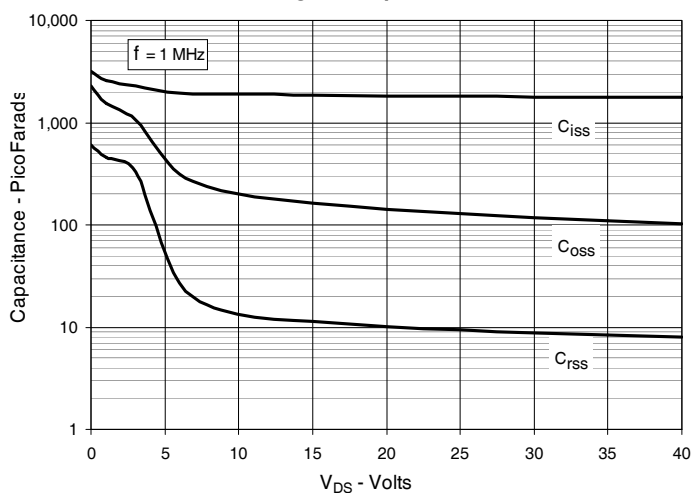
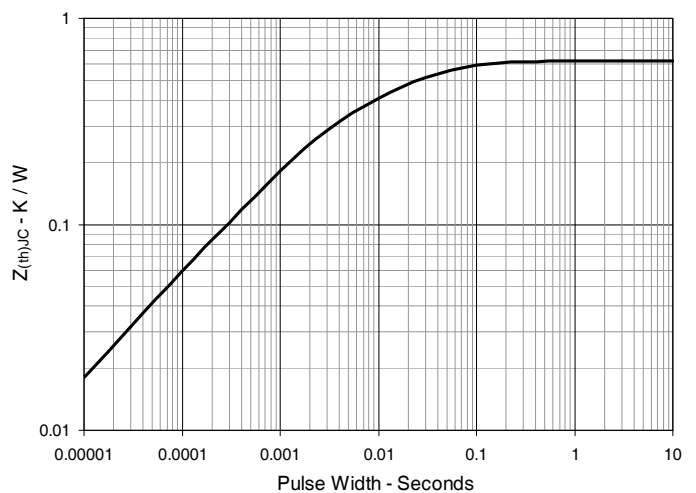

Fig. 12. Maximum Transient Thermal Impedance





Disclaimer Notice - Information furnished is believed to be accurate and reliable. However, users should independently evaluate the suitability of and test each product selected for their own applications. Littelfuse products are not designed for, and may not be used in, all applications. Read complete Disclaimer Notice at www.littelfuse.com/disclaimer-electronics.