

Polar3™ HiperFET™ Power MOSFET

IXFT50N60P3
IXFQ50N60P3
IXFH50N60P3

V_{DSS} = 600V
I_{D25} = 50A
R_{DS(on)} ≤ 160mΩ

N-Channel Enhancement Mode
Avalanche Rated
Fast Intrinsic Rectifier

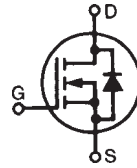

TO-268 (IXFT)

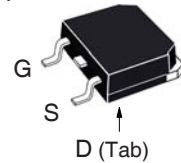

TO-3P (IXFQ)

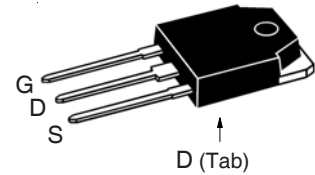

TO-247 (IXFH)

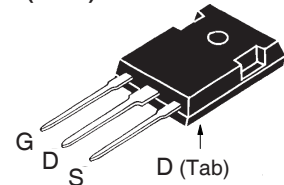

G = Gate D = Drain
S = Source Tab = Drain

Symbol	Test Conditions	Maximum Ratings	
V _{DSS}	T _J = 25°C to 150°C	600	V
V _{DGR}	T _J = 25°C to 150°C, R _{GS} = 1MΩ	600	V
V _{GSS}	Continuous	± 30	V
V _{GSM}	Transient	± 40	V
I _{D25}	T _C = 25°C	50	A
I _{DM}	T _C = 25°C, Pulse Width Limited by T _{JM}	125	A
I _A	T _C = 25°C	25	A
E _{AS}	T _C = 25°C	1	J
dv/dt	I _S ≤ I _{DM} , V _{DD} ≤ V _{DSS} , T _J ≤ 150°C	35	V/ns
P _D	T _C = 25°C	1040	W
T _J		-55 ... +150	°C
T _{JM}		150	°C
T _{stg}		-55 ... +150	°C
T _L	Maximum Lead Temperature for Soldering	300	°C
T _{SOLD}	Plastic Body for 10s	260	°C
M _d	Mounting Torque (TO-247 & TO-3P)	1.13 / 10	Nm/lb.in
Weight	TO-268	4.0	g
	TO-3P	5.5	g
	TO-247	6.0	g

Symbol	Test Conditions (T _J = 25°C Unless Otherwise Specified)	Characteristic Values		
		Min.	Typ.	Max.
BV _{DSS}	V _{GS} = 0V, I _D = 1mA	600		V
V _{GS(th)}	V _{DS} = V _{GS} , I _D = 4mA	3.0		5.0 V
I _{GSS}	V _{GS} = ±30V, V _{DS} = 0V			±100 nA
I _{DSS}	V _{DS} = V _{DSS} , V _{GS} = 0V T _J = 125°C			25 μA 2 mA
R _{DS(on)}	V _{GS} = 10V, I _D = 0.5 • I _{D25} , Note 1			160 mΩ

Features

- Fast Intrinsic Rectifier
- Avalanche Rated
- Low R_{DS(ON)} and Q_G
- Low Package Inductance

Advantages

- High Power Density
- Easy to Mount
- Space Savings

Applications

- Switch-Mode and Resonant-Mode Power Supplies
- DC-DC Converters
- Laser Drivers
- AC and DC Motor Drives
- Robotics and Servo Controls

Symbol	Test Conditions	Characteristic Values		
		Min.	Typ.	Max.
g_{fs}	$V_{DS} = 20V, I_D = 0.5 \cdot I_{D25}$, Note 1	32	55	S
C_{iss}	$V_{GS} = 0V, V_{DS} = 25V, f = 1MHz$		6300	pF
C_{oss}			630	pF
C_{rss}			2.5	pF
R_{Gi}	Gate Input Resistance		1.0	Ω
$t_{d(on)}$	Resistive Switching Times $V_{GS} = 10V, V_{DS} = 0.5 \cdot V_{DSS}, I_D = 0.5 \cdot I_{D25}$ $R_G = 1\Omega$ (External)		31	ns
t_r			20	ns
$t_{d(off)}$			62	ns
t_f			17	ns
$Q_{g(on)}$	$V_{GS} = 10V, V_{DS} = 0.5 \cdot V_{DSS}, I_D = 0.5 \cdot I_{D25}$		94	nC
Q_{gs}			27	nC
Q_{gd}			23	nC
R_{thJC}				0.12 $^{\circ}C/W$
R_{thCS}	(TO-247 & TO-3P)	0.25		$^{\circ}C/W$

Source-Drain Diode

Symbol	Test Conditions	Characteristic Values		
		Min.	Typ.	Max.
I_s	$V_{GS} = 0V$			50 A
I_{SM}	Repetitive, Pulse Width Limited by T_{JM}			200 A
V_{SD}	$I_F = I_s, V_{GS} = 0V$, Note 1			1.4 V
t_{rr}	$I_F = 25A, -di/dt = 100A/\mu s$ $V_R = 100V, V_{GS} = 0V$			250 ns
I_{RM}			11	A
Q_{RM}			1.1	μC

Note 1. Pulse test, $t \leq 300\mu s$, duty cycle, $d \leq 2\%$.

TO-268 Outline

Terminals: 1 - Gate, 2,4 - Drain, 3 - Source

SYM	INCHES		MILLIMETERS	
	MIN	MAX	MIN	MAX
A	.193	.201	4.90	5.10
A1	.106	.114	2.70	2.90
A2	.001	.010	0.02	0.25
b	.045	.057	1.15	1.45
b2	.075	.083	1.90	2.10
C	.016	.026	0.40	0.65
C2	.057	.063	1.45	1.60
D	.543	.551	13.80	14.00
D1	.488	.500	12.40	12.70
E	.624	.632	15.85	16.05
E1	.524	.535	13.30	13.60
e	.215 BSC		5.45 BSC	
H	.736	.752	18.70	19.10
L	.094	.106	2.40	2.70
L1	.047	.055	1.20	1.40
L2	.039	.045	1.00	1.15
L3	.010 BSC		0.25 BSC	
L4	.150	.161	3.80	4.10

TO-3P Outline

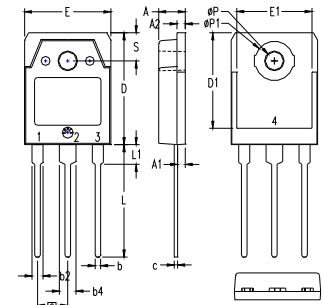

1 - GATE
2 - DRAIN
3 - SOURCE
4 - DRAIN

SYM	INCHES		MILLIMETERS	
	MIN	MAX	MIN	MAX
A	.185	.193	4.70	4.90
A1	.051	.059	1.30	1.50
A2	.057	.065	1.45	1.65
b	.035	.045	0.90	1.15
b2	.075	.087	1.90	2.20
b4	.114	.126	2.90	3.20
c	.022	.031	0.55	0.80
D	.780	.799	19.80	20.30
D1	.665	.677	16.90	17.20
E	.610	.622	15.50	15.80
E1	.531	.539	13.50	13.70
e	.215 BSC		5.45 BSC	
L	.779	.795	19.80	20.20
L1	.134	.142	3.40	3.60
ϕP	.126	.134	3.20	3.40
$\phi P1$.272	.280	6.90	7.10
S	.193	.201	4.90	5.10

TO-247 Outline

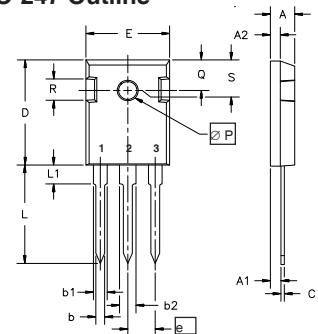

Terminals: 1 - Gate, 2 - Drain, 3 - Source

Dim.	Millimeter		Inches	
	Min.	Max.	Min.	Max.
A	4.7	5.3	.185	.209
A ₁	2.2	2.54	.087	.102
A ₂	2.2	2.6	.059	.098
b	1.0	1.4	.040	.055
b ₁	1.65	2.13	.065	.084
b ₂	2.87	3.12	.113	.123
C	.4	.8	.016	.031
D	20.80	21.46	.819	.845
E	15.75	16.26	.610	.640
e	5.20	5.72	0.205	0.225
L	19.81	20.32	.780	.800
L1		4.50		.177
ϕP	3.55	3.65	.140	.144
Q	5.89	6.40	0.232	0.252
R	4.32	5.49	.170	.216
S	6.15 BSC		242 BSC	

IXYS Reserves the Right to Change Limits, Test Conditions, and Dimensions.

IXYS MOSFETs and IGBTs are covered by one or more of the following U.S. patents:

4,835,592	4,931,844	5,049,961	5,237,481	6,162,665	6,404,065 B1	6,683,344	6,727,585	7,005,734 B2	7,157,338B2
4,850,072	5,017,508	5,063,307	5,381,025	6,259,123 B1	6,534,343	6,710,405 B2	6,759,692	7,063,975 B2	
4,881,106	5,034,796	5,187,117	5,486,715	6,306,728 B1	6,583,505	6,710,463	6,771,478 B2	7,071,537	

Fig. 1. Output Characteristics @ $T_J = 25^\circ\text{C}$

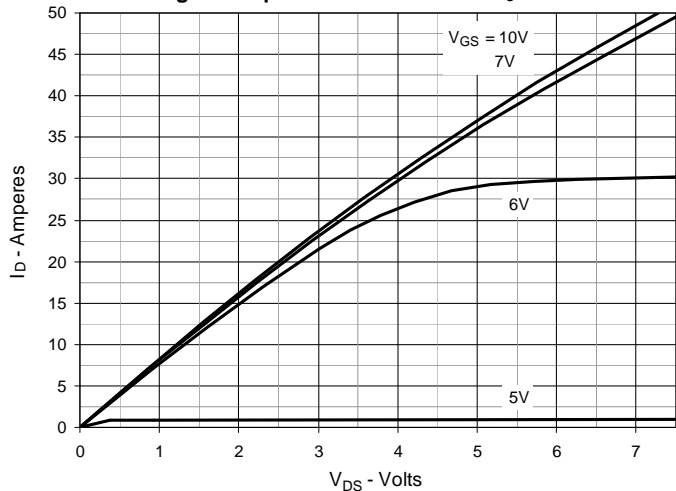

Fig. 2. Extended Output Characteristics @ $T_J = 25^\circ\text{C}$

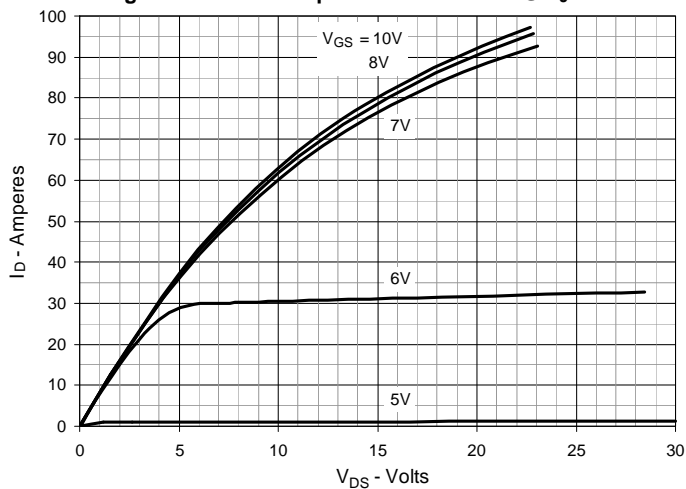

Fig. 3. Output Characteristics @ $T_J = 125^\circ\text{C}$

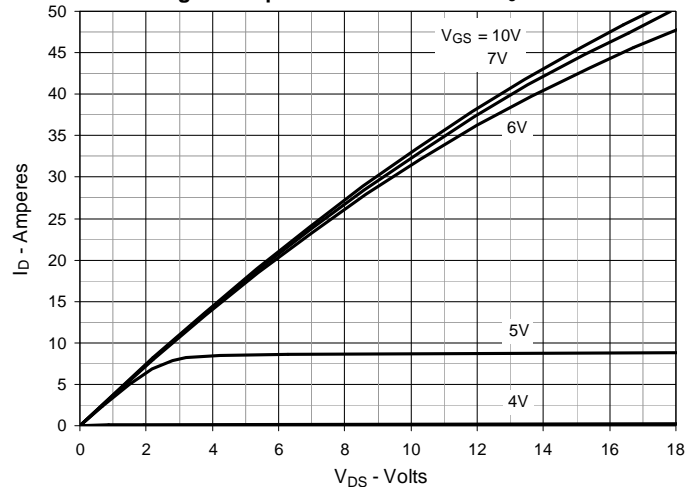

Fig. 4. $R_{DS(on)}$ Normalized to $I_D = 25\text{A}$ Value vs. Junction Temperature

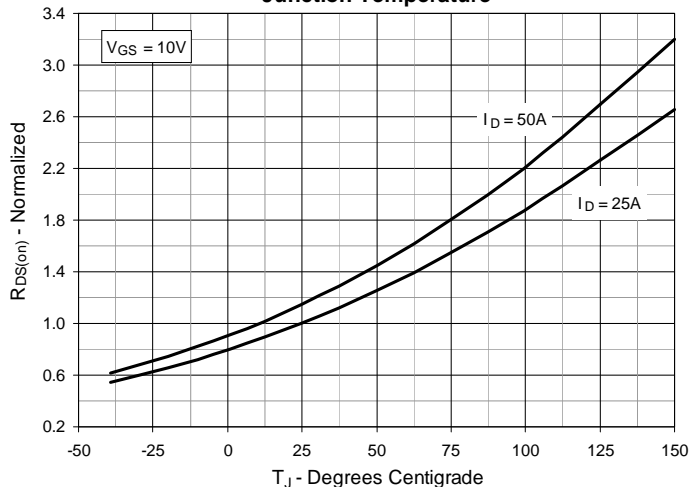

Fig. 5. $R_{DS(on)}$ Normalized to $I_D = 25\text{A}$ Value vs. Drain Current

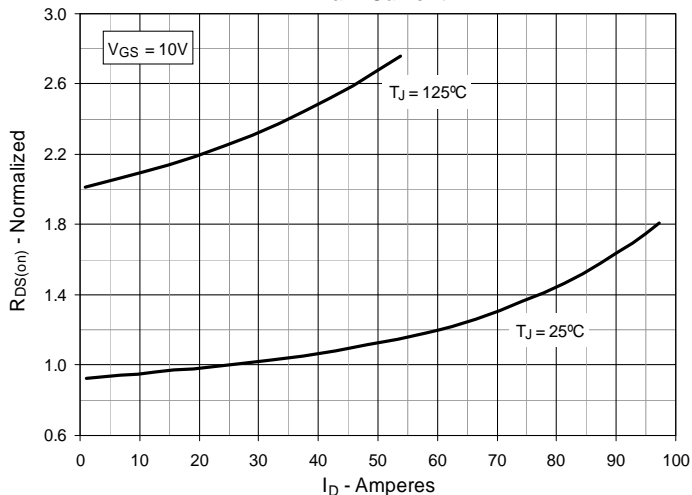

Fig. 6. Maximum Drain Current vs. Case Temperature

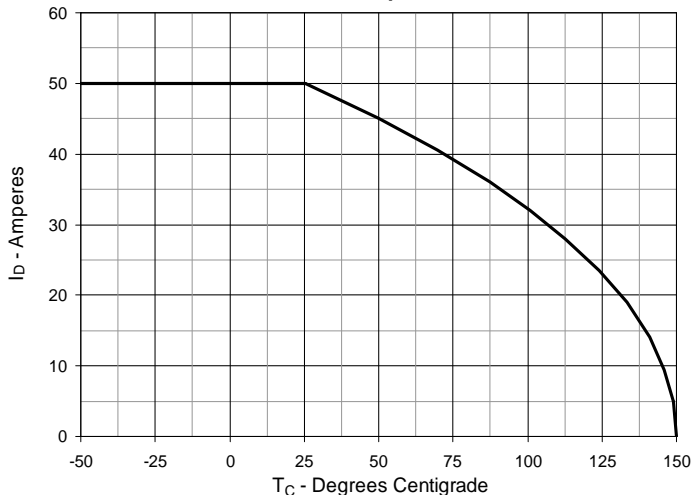

Fig. 7. Input Admittance

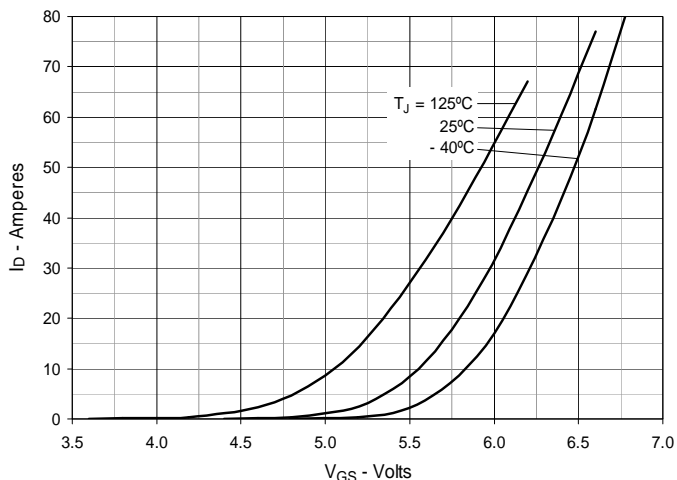

Fig. 8. Transconductance

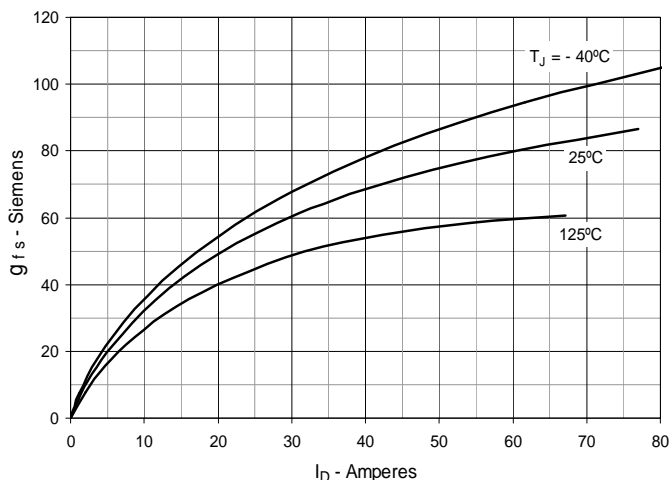

Fig. 9. Forward Voltage Drop of Intrinsic Diode

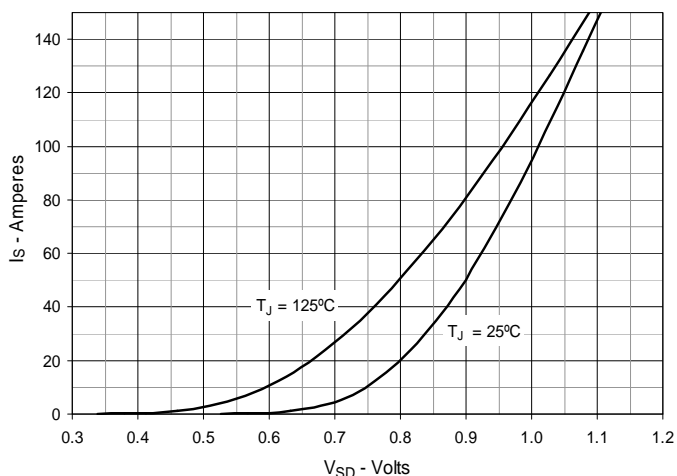

Fig. 10. Gate Charge

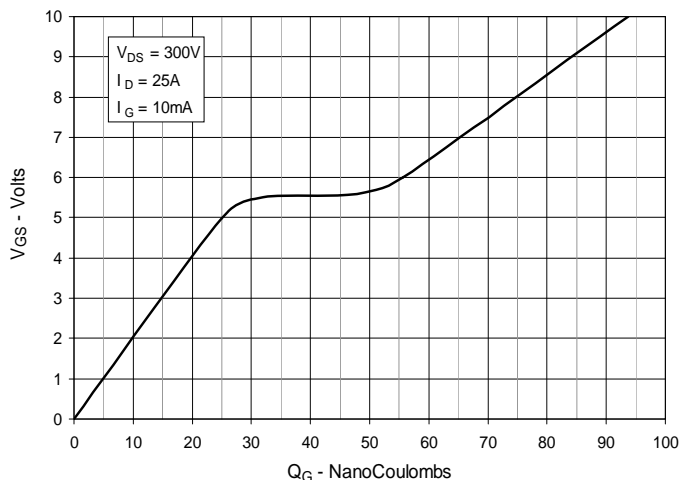

Fig. 11. Capacitance

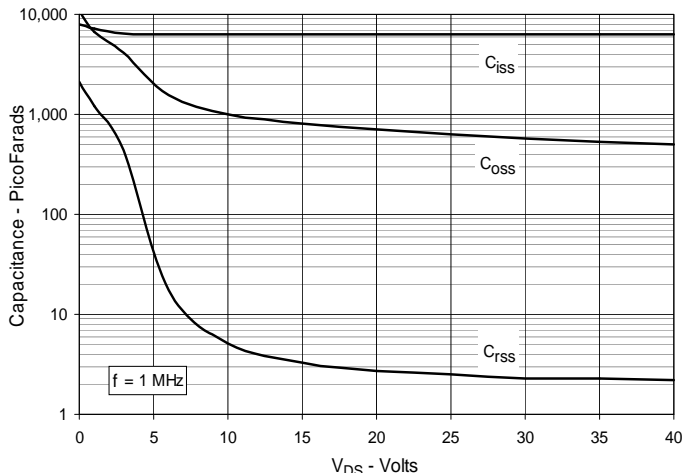

Fig. 12. Forward-Bias Safe Operating Area

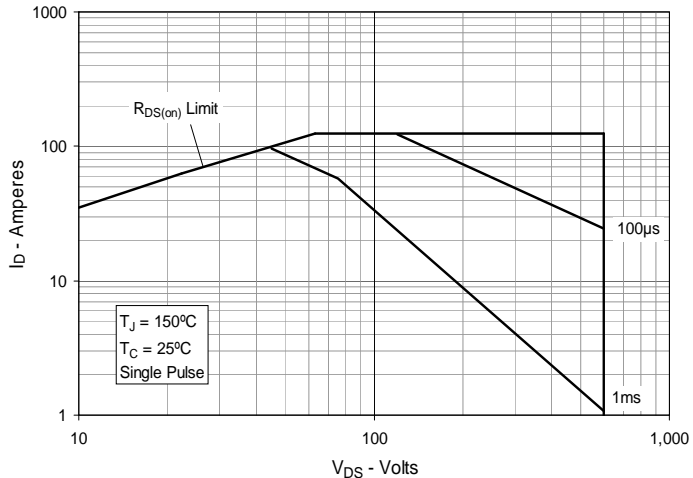
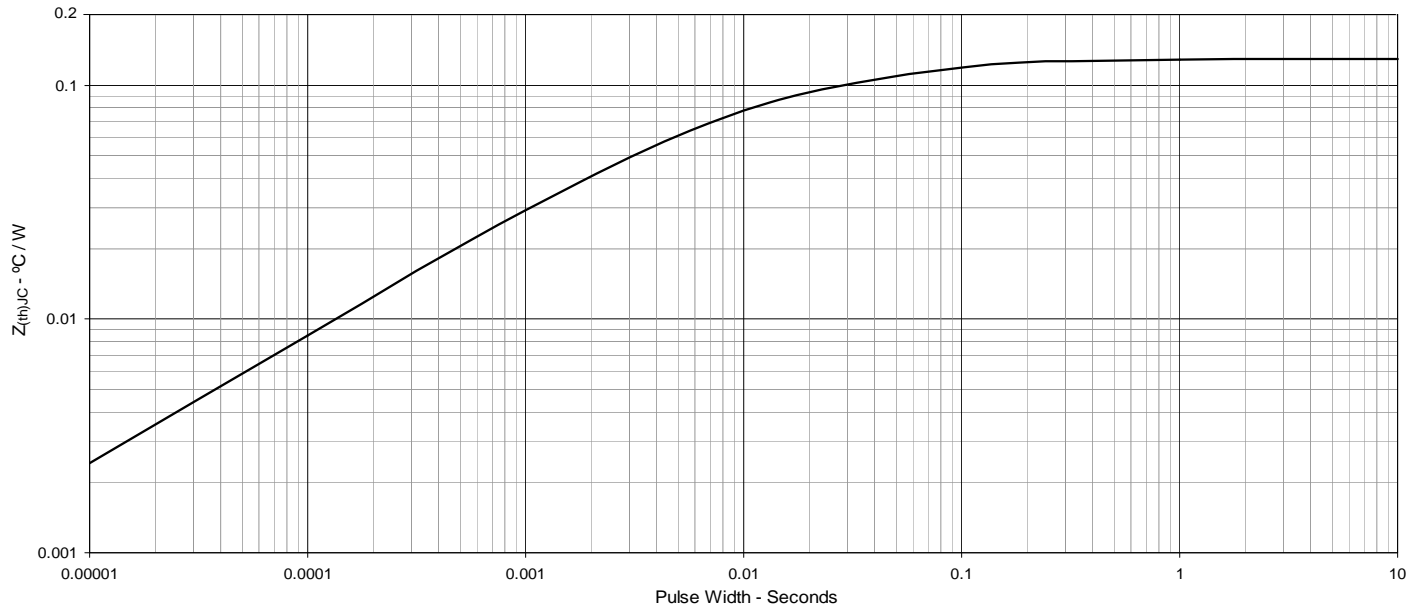

Fig. 13. Maximum Transient Thermal Impedance





Disclaimer Notice - Information furnished is believed to be accurate and reliable. However, users should independently evaluate the suitability of and test each product selected for their own applications. Littelfuse products are not designed for, and may not be used in, all applications. Read complete Disclaimer Notice at www.littelfuse.com/disclaimer-electronics.