

HiPerFET™ Power MOSFETs Q-Class

IXFH 4N100Q
IXFT 4N100Q

V_{DSS} = 1000 V
I_{D25} = 4 A
R_{DS(on)} = 3.0 Ω

t_{rr} ≤ 250 ns

N-Channel Enhancement Mode
Avalanche Rated, Low Q_g, High dv/dt

Preliminary Data Sheet

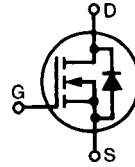

Symbol	Test Conditions	Maximum Ratings	
V _{DSS}	T _J = 25°C to 150°C	1000	V
V _{DGR}	T _J = 25°C to 150°C; R _{GS} = 1 MΩ	1000	V
V _{GS}	Continuous	±20	V
V _{GSM}	Transient	±30	V
I _{D25}	T _C = 25°C	4	A
I _{DM}	T _C = 25°C, pulse width limited by T _{JM}	16	A
I _{AR}	T _C = 25°C	4	A
E _{AR}	T _C = 25°C	20	mJ
E _{AS}		700	mJ
dv/dt	I _S ≤ I _{DM} , di/dt ≤ 100 A/μs, V _{DD} ≤ V _{DSS} , T _J ≤ 150°C, R _G = 2 Ω	5	V/ns
P _D	T _C = 25°C	150	W
T _J		-55 to +150	°C
T _{JM}		150	°C
T _{stg}		-55 to +150	°C
T _L	1.6 mm (0.063 in) from case for 10 s	300	°C
M _d	Mounting torque	1.13/10	Nm/lb.in.
Weight	TO-247	6	g
	TO-268	4	g

TO-247 AD (IXFH)

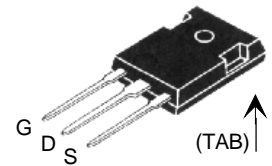

TO-268 (D3) (IXFT)

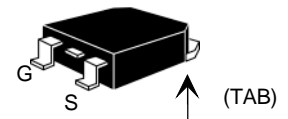

G = Gate D = Drain
S = Source TAB = Drain

Features

- IXYS advanced low Q_g process
- Low gate charge and capacitances
 - easier to drive
 - faster switching
- International standard packages
- Low R_{DS(on)}
- Unclamped Inductive Switching (UIS) rated
- Molding epoxies meet UL94 V-0 flammability classification

Advantages

- Easy to mount
- Space savings
- High power density

Symbol	Test Conditions	Characteristic Values (T _J = 25°C, unless otherwise specified)		
		min.	typ.	max.
V _{DSS}	V _{GS} = 0 V, I _D = 1 mA	1000		V
V _{GS(th)}	V _{DS} = V _{GS} , I _D = 1.5 mA	3.0		V
I _{GSS}	V _{GS} = ±20 V _{DC} , V _{DS} = 0			±100 nA
I _{DSS}	V _{DS} = V _{DSS} V _{GS} = 0 V		T _J = 25°C T _J = 125°C	50 μA 1 mA
R _{DS(on)}	V _{GS} = 10 V, I _D = 0.5 I _{D25} Pulse test, t ≤ 300 μs, duty cycle d ≤ 2 %			3.0 Ω

Symbol	Test Conditions	Characteristic Values ($T_J = 25^\circ\text{C}$, unless otherwise specified)		
		min.	typ.	max.
g_{fs}	$V_{DS} = 20\text{ V}; I_D = 0.5 \cdot I_{D25}$, pulse test	1.5	2.5	S
C_{iss}	$V_{GS} = 0\text{ V}, V_{DS} = 25\text{ V}, f = 1\text{ MHz}$		1050	pF
C_{oss}			120	pF
C_{rss}			30	pF
$t_{d(on)}$	$V_{GS} = 10\text{ V}, V_{DS} = 0.5 \cdot V_{DSS}, I_D = 0.5 \cdot I_{D25}$ $R_G = 4.7\ \Omega$ (External),		17	ns
t_r			15	ns
$t_{d(off)}$			32	ns
t_f			18	ns
$Q_{g(on)}$	$V_{GS} = 10\text{ V}, V_{DS} = 0.5 \cdot V_{DSS}, I_D = 0.5 \cdot I_{D25}$		39	nC
Q_{gs}			9	nC
Q_{gd}			22	nC
R_{thJC}	(TO-247)		0.8	K/W
R_{thCK}			0.25	K/W

TO-247 AD (IXFH) Outline

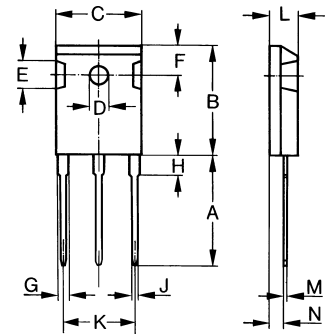

Dim.	Millimeter		Inches	
	Min.	Max.	Min.	Max.
A	19.81	20.32	0.780	0.800
B	20.80	21.46	0.819	0.845
C	15.75	16.26	0.610	0.640
D	3.55	3.65	0.140	0.144
E	4.32	5.49	0.170	0.216
F	5.4	6.2	0.212	0.244
G	1.65	2.13	0.065	0.084
H	-	4.5	-	0.177
J	1.0	1.4	0.040	0.055
K	10.8	11.0	0.426	0.433
L	4.7	5.3	0.185	0.209
M	0.4	0.8	0.016	0.031
N	1.5	2.49	0.087	0.102

Symbol	Test Conditions	Characteristic Values ($T_J = 25^\circ\text{C}$, unless otherwise specified)		
		min.	typ.	max.
I_S	$V_{GS} = 0\text{ V}$			4 A
I_{SM}	Repetitive; pulse width limited by T_{JM}			16 A
V_{SD}	$I_F = I_S, V_{GS} = 0\text{ V}$, Pulse test, $t \leq 300\ \mu\text{s}$, duty cycle $d \leq 2\%$			1.5 V
t_{rr}	$I_F = I_S, -di/dt = 100\text{ A}/\mu\text{s}, V_R = 100\text{ V}$		0.52	250 ns
Q_{RM}			1.8	μC
I_{RM}				A

TO-268AA (D³ PAK)

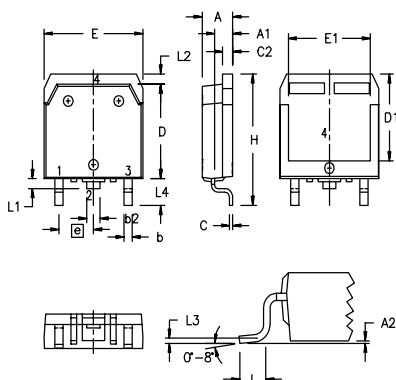

Dim.	Millimeter		Inches	
	Min.	Max.	Min.	Max.
A	4.9	5.1	.193	.201
A ₁	2.7	2.9	.106	.114
A ₂	.02	.25	.001	.010
b	1.15	1.45	.045	.057
b ₂	1.9	2.1	.75	.83
C	.4	.65	.016	.026
D	13.80	14.00	.543	.551
E	15.85	16.05	.624	.632
E ₁	13.3	13.6	.524	.535
e	5.45 BSC		.215 BSC	
H	18.70	19.10	.736	.752
L	2.40	2.70	.094	.106
L ₁	1.20	1.40	.047	.055
L ₂	1.00	1.15	.039	.045
L ₃	0.25 BSC		.010 BSC	
L ₄	3.80	4.10	.150	.161

Min. Recommended Footprint

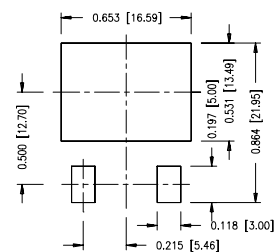

Figure 1. Output Characteristics at 25°C

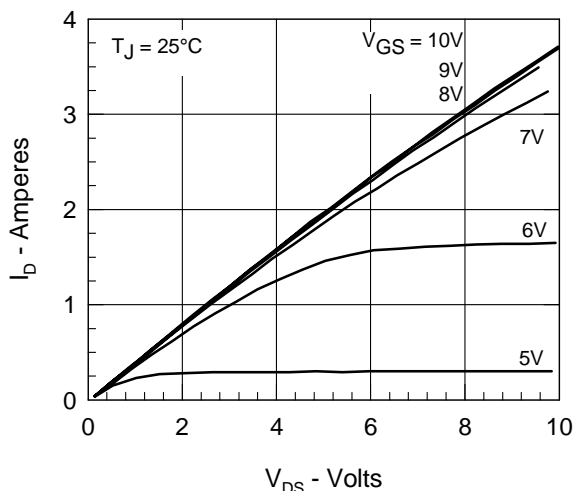

Figure 2. Extended Output Characteristics at 125°C

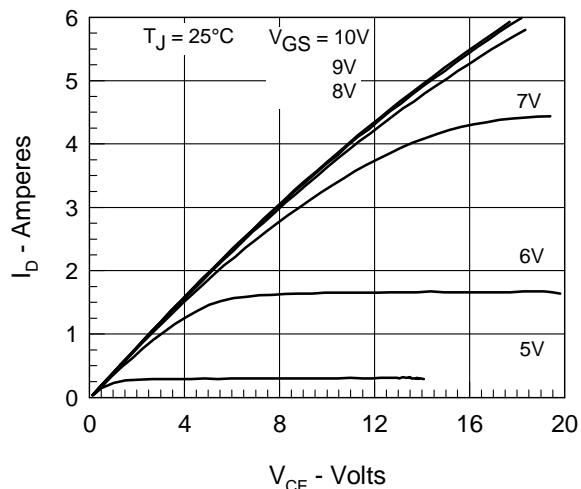

Figure 3. $R_{DS(on)}$ normalized to 0.5 I_{D25} value vs. I_D

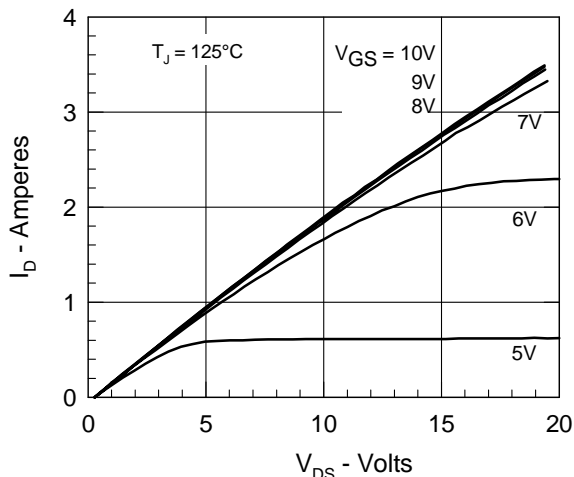

Figure 4. Admittance Curves

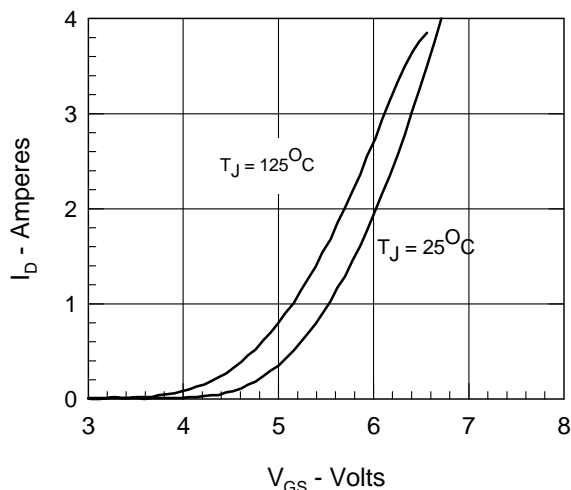

Figure 5. $R_{DS(on)}$ normalized to 0.5 I_{D25} value vs. I_D

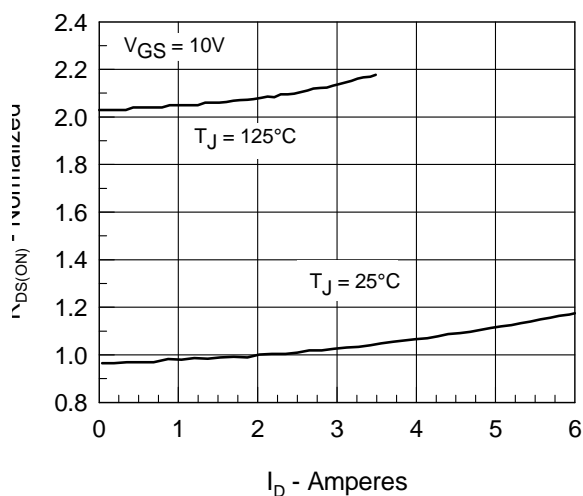

Figure 6. $R_{DS(on)}$ normalized to 0.5 I_{D25} value vs. T_J

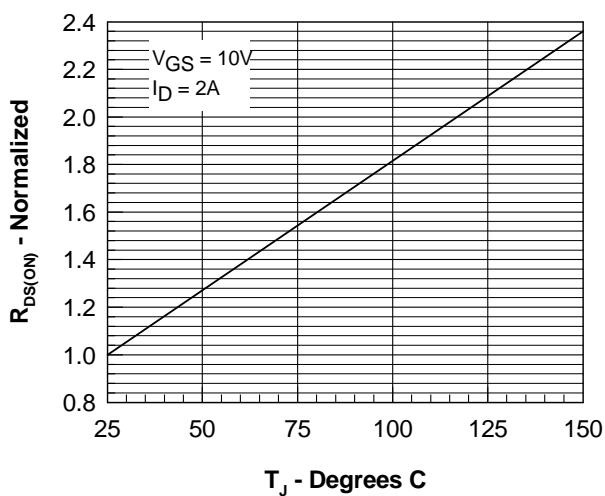

Figure 7. Gate Charge

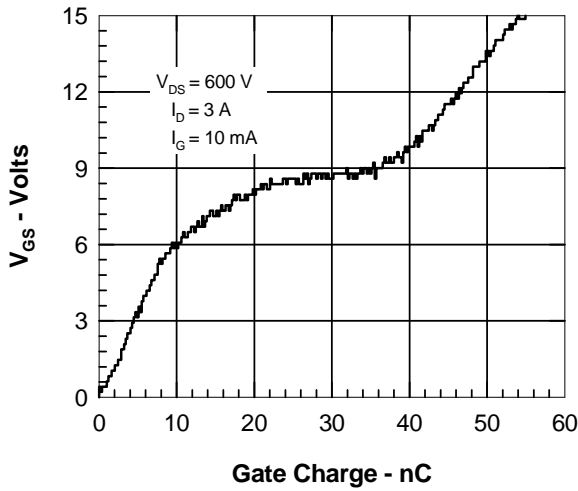

Figure 8. Capacitance Curves

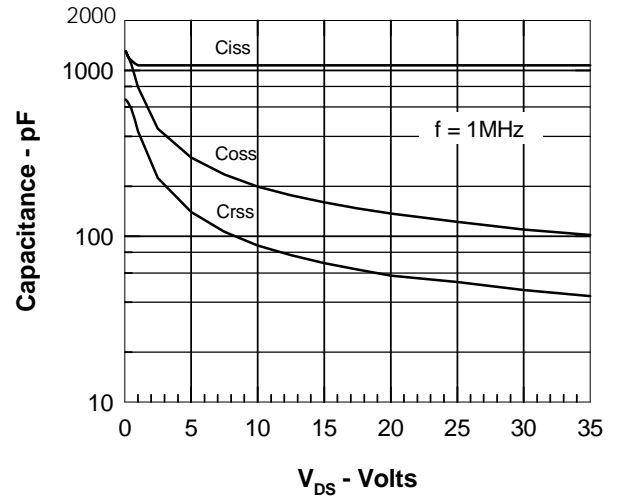

Figure 9. Forward Voltage Drop of the Intrinsic Diode

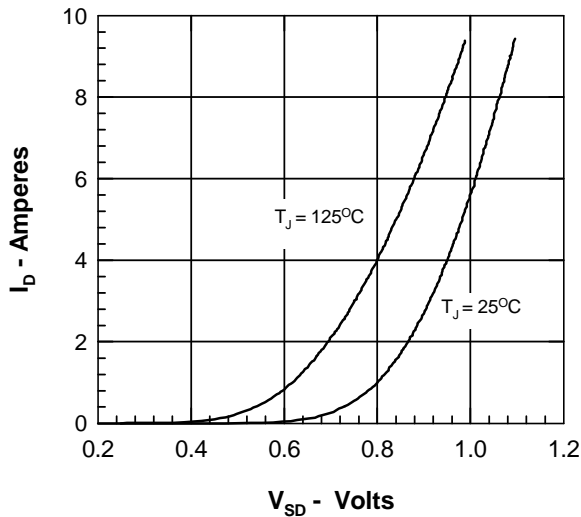

Figure 10. Drain Current vs. Case Temperature

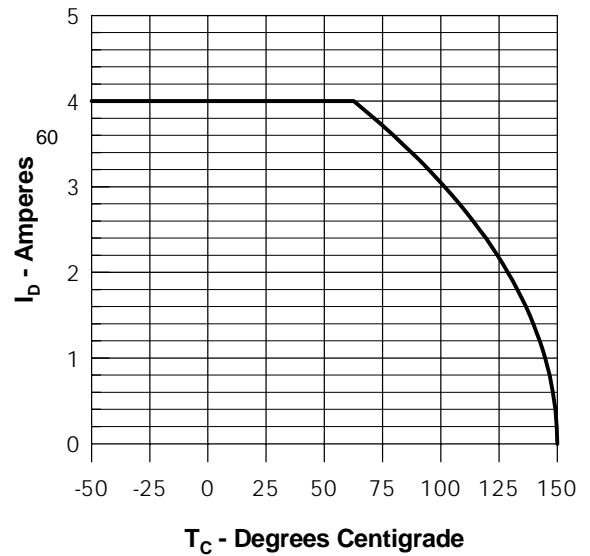
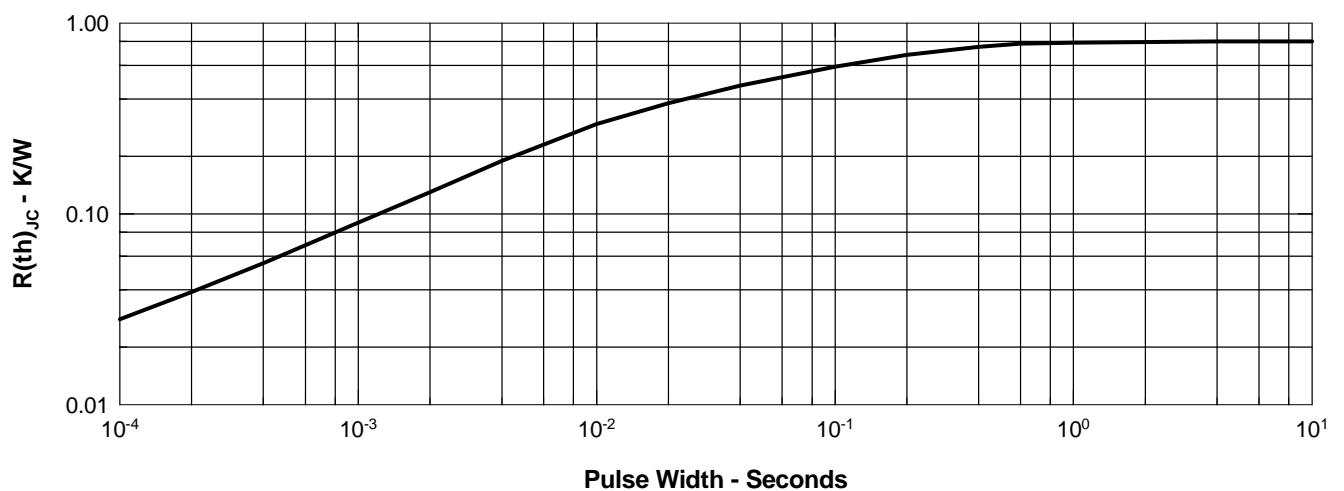

Figure 11. Transient Thermal Resistance





Disclaimer Notice - Information furnished is believed to be accurate and reliable. However, users should independently evaluate the suitability of and test each product selected for their own applications. Littelfuse products are not designed for, and may not be used in, all applications. Read complete Disclaimer Notice at www.littelfuse.com/disclaimer-electronics.