

**Q3-Class
HiperFET™
Power MOSFET**

**IXFK48N60Q3
IXFX48N60Q3**

**V_{DSS} = 600V
I_{D25} = 48A
R_{DS(on)} ≤ 140mΩ
t_{rr} ≤ 300ns**

N-Channel Enhancement Mode
Avalanche Rated
Fast Intrinsic Rectifier

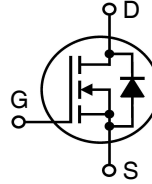

**TO-264
(IXFK)**

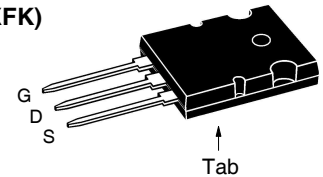

**PLUS247
(IXFX)**

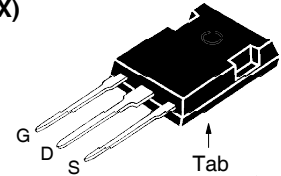

G = Gate D = Drain
S = Source Tab = Drain

Symbol	Test Conditions	Maximum Ratings	
V _{DSS}	T _J = 25°C to 150°C	600	V
V _{DGR}	T _J = 25°C to 150°C, R _{GS} = 1MΩ	600	V
V _{GSS}	Continuous	±30	V
V _{GSM}	Transient	±40	V
I _{D25}	T _C = 25°C	48	A
I _{DM}	T _C = 25°C, Pulse Width Limited by T _{JM}	120	A
I _A	T _C = 25°C	48	A
E _{AS}	T _C = 25°C	2	J
dv/dt	I _S ≤ I _{DM} , V _{DD} ≤ V _{DSS} , T _J ≤ 150°C	50	V/ns
P _D	T _C = 25°C	1000	W
T _J		-55 ... +150	°C
T _{JM}		150	°C
T _{stg}		-55 ... +150	°C
T _L	Maximum Lead Temperature for Soldering	300	°C
T _{SOLD}	1.6 mm (0.062in.) from Case for 10s	260	°C
M _d	Mounting Torque (TO-264)	1.13/10	Nm/lb.in.
F _C	Mounting Force (PLUS247)	20..120 / 4.5..27	N/lb.
Weight	TO-264	10	g
	PLUS247	6	g

Features

- Low Intrinsic Gate Resistance
- Low Package Inductance
- Fast Intrinsic Rectifier
- Low R_{DS(on)} and Q_G

Advantages

- High Power Density
- Easy to Mount
- Space Savings

Applications

- DC-DC Converters
- Battery Chargers
- Switch-Mode and Resonant-Mode Power Supplies
- DC Choppers
- Temperature and Lighting Controls

Symbol	Test Conditions (T _J = 25°C Unless Otherwise Specified)	Characteristic Values		
		Min.	Typ.	Max.
BV _{DSS}	V _{GS} = 0V, I _D = 1mA	600		V
V _{GS(th)}	V _{DS} = V _{GS} , I _D = 4mA	3.5		6.5 V
I _{GSS}	V _{GS} = ±30V, V _{DS} = 0V			±200 nA
I _{DSS}	V _{DS} = V _{DSS} , V _{GS} = 0V T _J = 125°C			25 μA 1 mA
R _{DS(on)}	V _{GS} = 10V, I _D = 0.5 • I _{D25} , Note 1			140 mΩ

Symbol	Test Conditions ($T_J = 25^\circ\text{C}$ Unless Otherwise Specified)	Characteristic Values		
		Min.	Typ.	Max.
g_{fs}	$V_{DS} = 20\text{V}, I_D = 0.5 \cdot I_{D25}$, Note 1	20	36	S
C_{iss}	$V_{GS} = 0\text{V}, V_{DS} = 25\text{V}, f = 1\text{MHz}$		7020	pF
C_{oss}			790	pF
C_{rss}			70	pF
R_{Gi}	Gate Input Resistance		0.13	Ω
$t_{d(on)}$	Resistive Switching Times $V_{GS} = 10\text{V}, V_{DS} = 0.5 \cdot V_{DSS}, I_D = 0.5 \cdot I_{D25}$ $R_G = 1\Omega$ (External)		37	ns
t_r			11	ns
$t_{d(off)}$			40	ns
t_f			9	ns
$Q_{g(on)}$	$V_{GS} = 10\text{V}, V_{DS} = 0.5 \cdot V_{DSS}, I_D = 0.5 \cdot I_{D25}$		140	nC
Q_{gs}			54	nC
Q_{gd}			60	nC
R_{thJC}				0.125 $^\circ\text{C/W}$
R_{thCS}		0.15		$^\circ\text{C/W}$

Source-Drain Diode

Symbol	Test Conditions ($T_J = 25^\circ\text{C}$ Unless Otherwise Specified)	Characteristic Values		
		Min.	Typ.	Max.
I_S	$V_{GS} = 0\text{V}$			48 A
I_{SM}	Repetitive, Pulse Width Limited by T_{JM}			192 A
V_{SD}	$I_F = I_S, V_{GS} = 0\text{V}$, Note 1			1.4 V
t_{rr}	$I_F = 24\text{A}, -di/dt = 100\text{A}/\mu\text{s}$ $V_R = 100\text{V}, V_{GS} = 0\text{V}$		2.2	300 ns
Q_{RM}				μC
I_{RM}				A
			15.4	

Note 1. Pulse test, $t \leq 300\mu\text{s}$, duty cycle, $d \leq 2\%$.

IXYS Reserves the Right to Change Limits, Test Conditions, and Dimensions.

IXYS MOSFETs and IGBTs are covered by one or more of the following U.S. patents:	4,835,592	4,931,844	5,049,961	5,237,481	6,162,665	6,404,065 B1	6,683,344	6,727,585	7,005,734 B2	7,157,338B2
	4,860,072	5,017,508	5,063,307	5,381,025	6,259,123 B1	6,534,343	6,710,405 B2	6,759,692	7,063,975 B2	
	4,881,106	5,034,796	5,187,117	5,486,715	6,306,728 B1	6,583,505	6,710,463	6,771,478 B2	7,071,537	

Fig. 1. Output Characteristics @ $T_J = 25^\circ\text{C}$

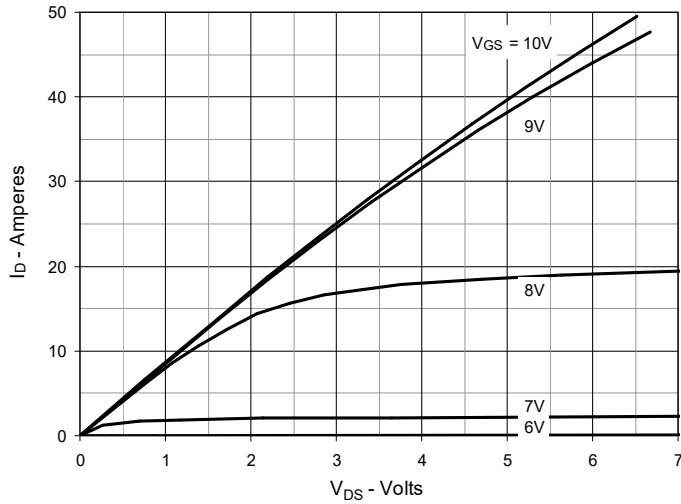

Fig. 2. Extended Output Characteristics @ $T_J = 25^\circ\text{C}$

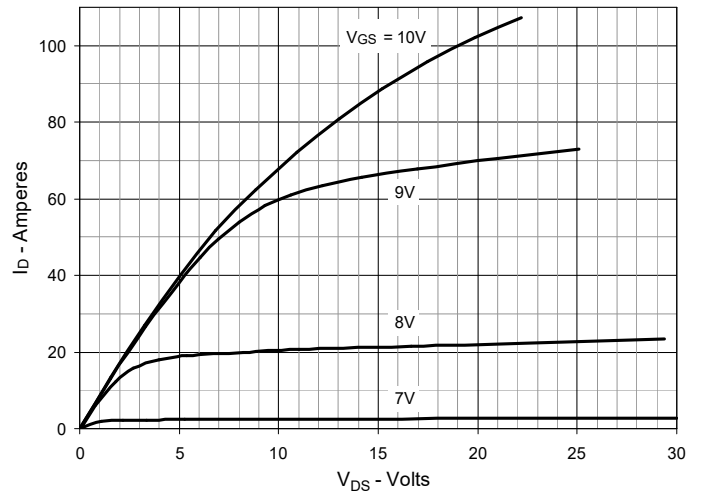

Fig. 3. Output Characteristics @ $T_J = 125^\circ\text{C}$

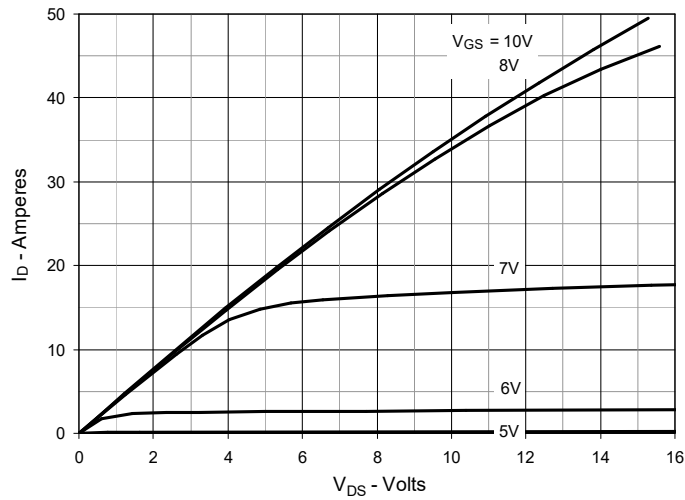

Fig. 4. $R_{DS(on)}$ Normalized to $I_D = 24\text{A}$ Value vs. Junction Temperature

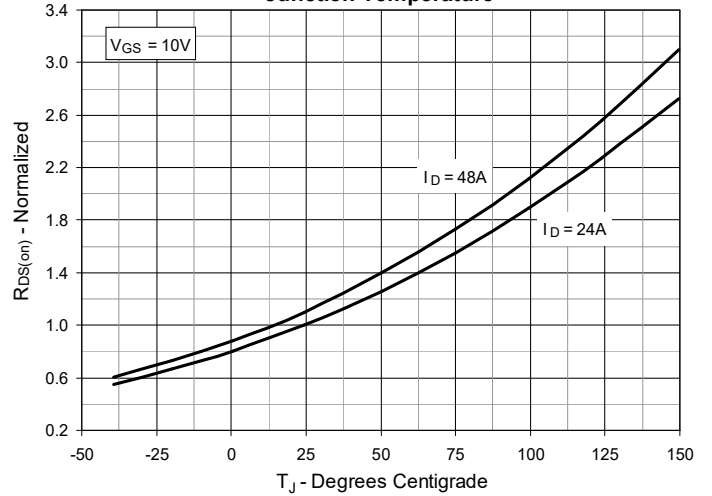

Fig. 5. $R_{DS(on)}$ Normalized to $I_D = 24\text{A}$ Value vs. Drain Current

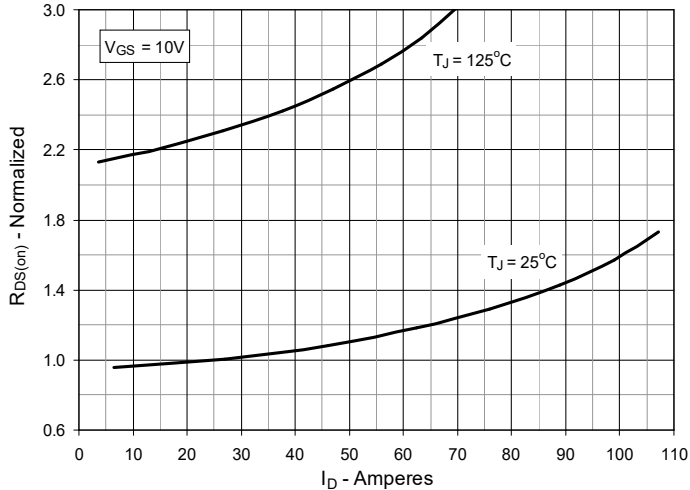

Fig. 6. Maximum Drain Current vs. Case Temperature

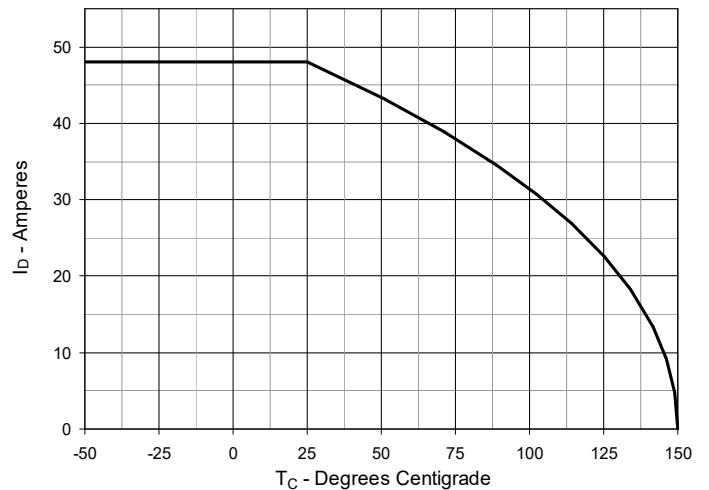

Fig. 7. Input Admittance

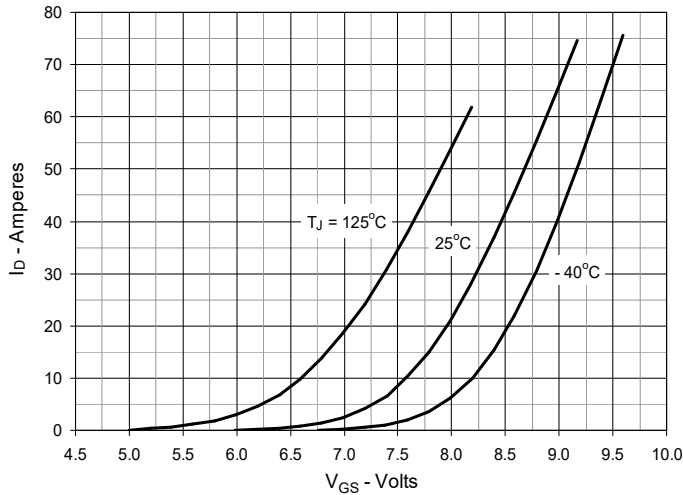

Fig. 8. Transconductance

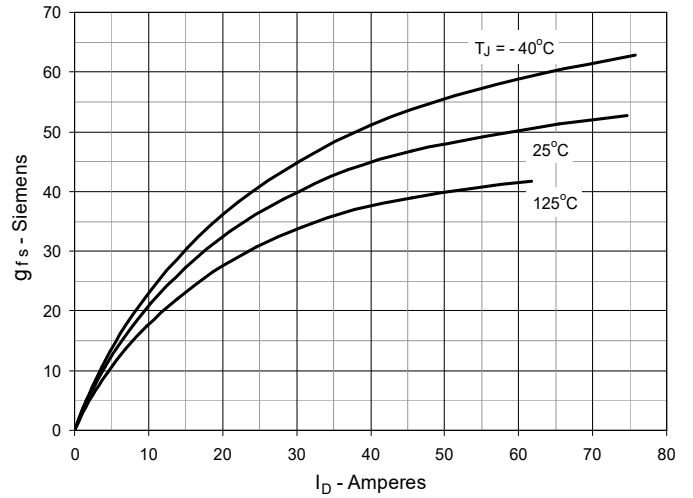

Fig. 9. Forward Voltage Drop of Intrinsic Diode

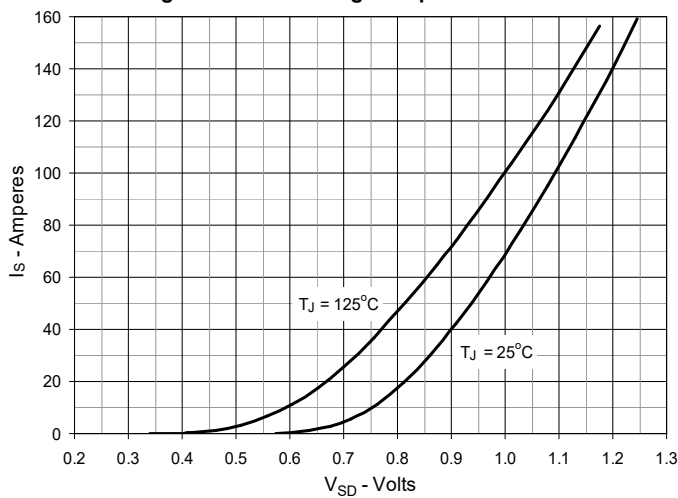

Fig. 10. Gate Charge

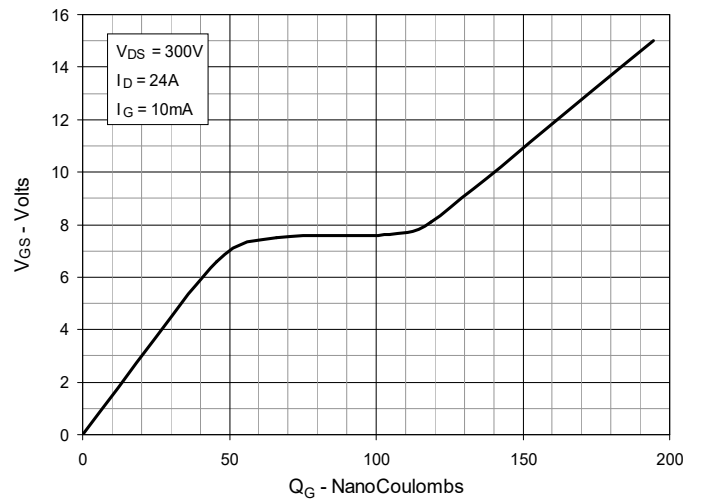

Fig. 11. Capacitance

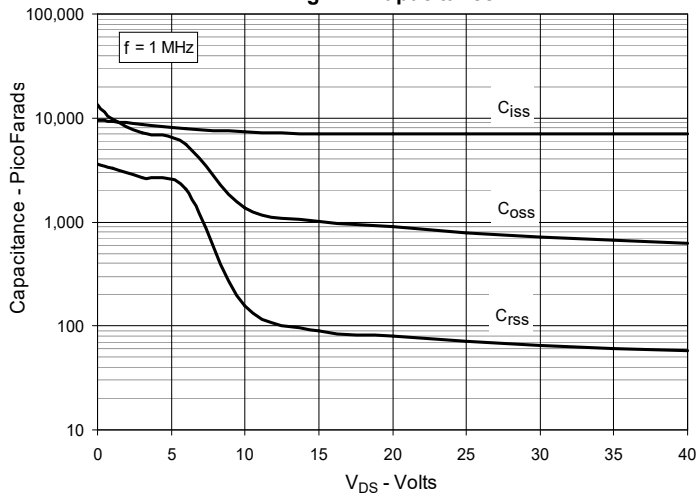

Fig. 12. Forward-Bias Safe Operating Area

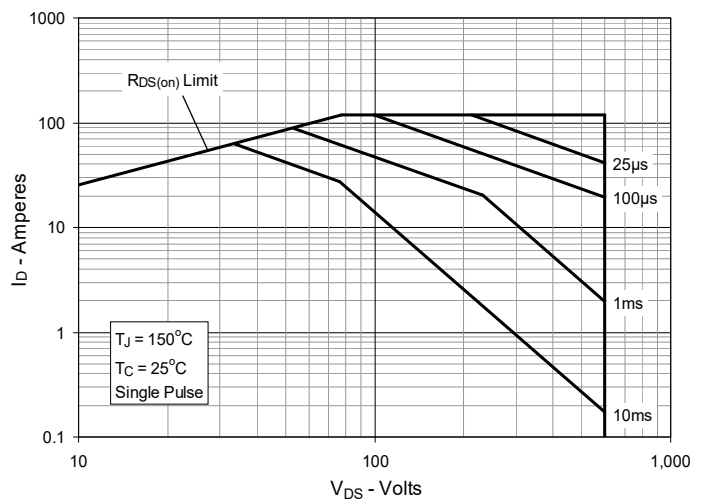
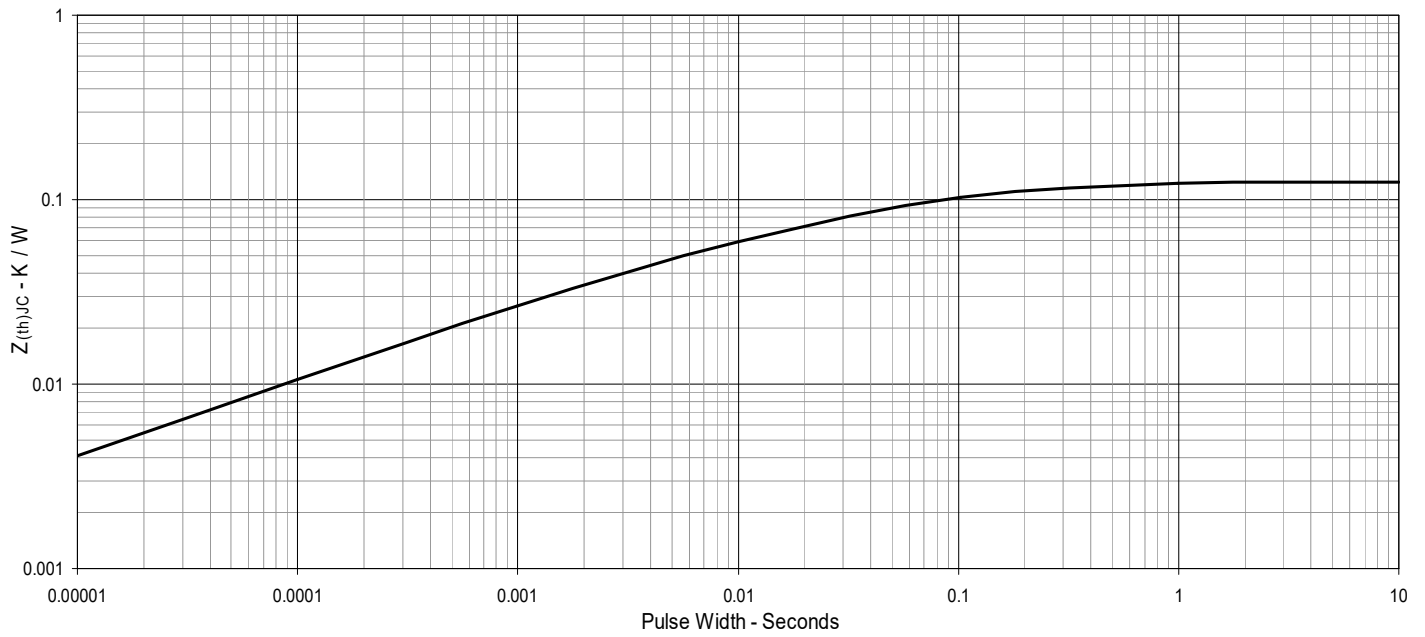
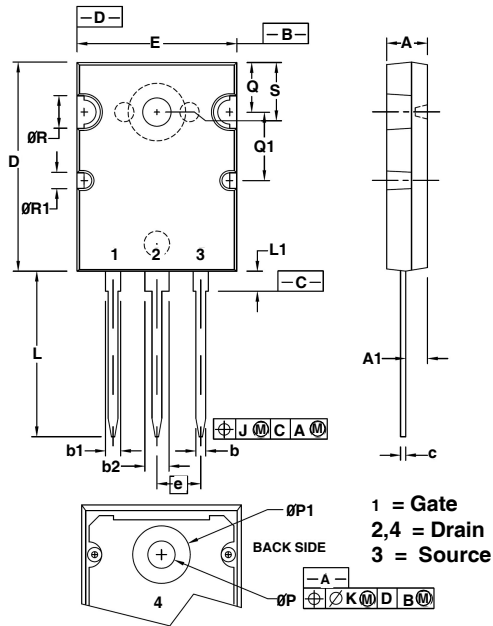
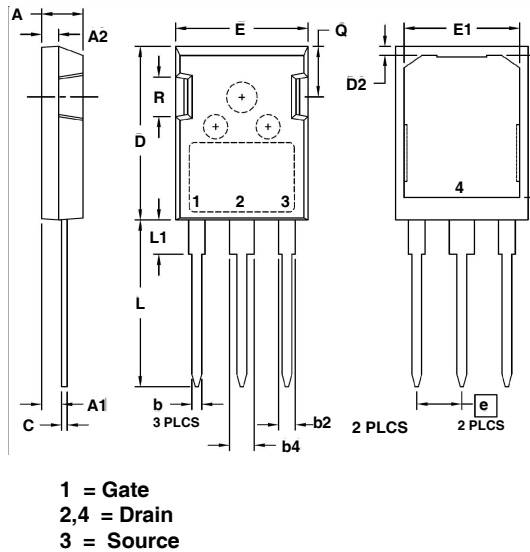

Fig. 13. Maximum Transient Thermal Impedance



TO-264 Outline

SYMBOL	INCHES		MILLIMETERS	
	MIN	MAX	MIN	MAX
A	.185	.209	4.70	5.31
A1	.102	.118	2.59	3.00
b	.037	.055	0.94	1.40
b1	.087	.102	2.21	2.59
b2	.110	.126	2.79	3.20
c	.017	.029	0.43	0.74
D	1.007	1.047	25.58	26.59
E	.760	.799	19.30	20.29
e	.215BSC		5.46 BSC	
J	.000	.010	0.00	0.25
K	.000	.010	0.00	0.25
L	.779	.842	19.79	21.39
L1	.087	.102	2.21	2.59
øP	.122	.138	3.10	3.51
øP1	.270	.290	6.86	7.37
Q	.240	.256	6.10	6.50
Q1	.330	.346	8.38	8.79
øR	.155	.187	3.94	4.75
øR1	.085	.093	2.16	2.36
S	.243	.253	6.17	6.43

PLUS247™ Outline

SYM	INCHES		MILLIMETERS	
	MIN	MAX	MIN	MAX
A	.190	.205	4.83	5.21
A1	.090	.100	2.29	2.54
A2	.075	.085	1.91	2.16
b	.045	.055	1.14	1.40
b2	.075	.087	1.91	2.20
b4	.115	.126	2.92	3.20
C	.024	.031	0.61	0.80
D	.819	.840	20.80	21.34
D1	.650	.690	16.51	17.53
D2	.035	.050	0.89	1.27
E	.620	.635	15.75	16.13
E1	.520	.560	13.08	14.22
e	.215 BSC		5.45 BSC	
L	.780	.810	19.81	20.57
L1	.150	.170	3.81	4.32
Q	.220	.244	5.59	6.20
R	.170	.190	4.32	4.83



Disclaimer Notice - Information furnished is believed to be accurate and reliable. However, users should independently evaluate the suitability of and test each product selected for their own applications. Littelfuse products are not designed for, and may not be used in, all applications. Read complete Disclaimer Notice at www.littelfuse.com/disclaimer-electronics.
