

# PolarHV™ HiPerFET Power MOSFET

IXFK 48N60P  
IXFX 48N60P

$V_{DSS} = 600\text{ V}$   
 $I_{D2} = 48\text{ A}$   
 $R_{DS(on)} \leq 135\text{ m}\Omega$   
 $t_{rr} \leq 200\text{ ns}$

N-Channel Enhancement Mode  
Avalanche Rated  
Fast Intrinsic Diode

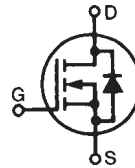

Symbol	Test Conditions	Maximum Ratings	
$V_{DSS}$	$T_J = 25^\circ\text{C}$ to $150^\circ\text{C}$	600	V
$V_{DGR}$	$T_J = 25^\circ\text{C}$ to $150^\circ\text{C}$ ; $R_{GS} = 1\text{ M}\Omega$	600	V
$V_{GSS}$	Continuous	$\pm 30$	V
$V_{GSM}$	Transient	$\pm 40$	V
$I_{D25}$	$T_C = 25^\circ\text{C}$	48	A
$I_{DM}$	$T_C = 25^\circ\text{C}$ , pulse width limited by $T_{JM}$	110	A
$I_{AR}$	$T_C = 25^\circ\text{C}$	48	A
$E_{AR}$	$T_C = 25^\circ\text{C}$	70	mJ
$E_{AS}$	$T_C = 25^\circ\text{C}$	2.0	J
$dv/dt$	$I_S \leq I_{DM}$ , $di/dt \leq 100\text{ A}/\mu\text{s}$ , $V_{DD} \leq V_{DSS}$ , $T_J \leq 150^\circ\text{C}$ , $R_G = 4\ \Omega$	20	V/ns
$P_D$	$T_C = 25^\circ\text{C}$	830	W
$T_J$		-55 ... +150	$^\circ\text{C}$
$T_{JM}$		150	$^\circ\text{C}$
$T_{stg}$		-55 ... +150	$^\circ\text{C}$
$M_d$	Mounting torque (TO-264)	1.13/10 Nm/lb.in.	
Weight	TO-264	10	g
	PLUS247	6	g
$T_L$	1.6 mm (0.062 in.) from case for 10 s	300	$^\circ\text{C}$
$T_{SOLD}$	Plastic body for 10 s	260	$^\circ\text{C}$

TO-264 (IXFK)

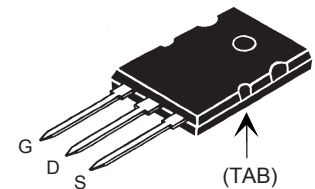

PLUS247 (IXFX)

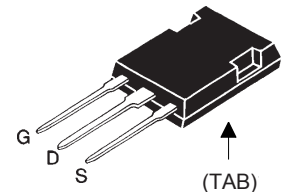

G = Gate    D = Drain  
S = Source    Tab = Drain

## Features

- † International standard packages
- † Fast recovery diode
- † Unclamped Inductive Switching (UIS) rated
- † Low package inductance
- easy to drive and to protect

## Advantages

- † Easy to mount
- † Space savings
- † High power density

Symbol	Test Conditions ( $T_J = 25^\circ\text{C}$ , unless otherwise specified)	Characteristic Values		
		Min.	Typ.	Max.
$BV_{DSS}$	$V_{GS} = 0\text{ V}$ , $I_D = 250\ \mu\text{A}$	600		V
$V_{GS(th)}$	$V_{DS} = V_{GS}$ , $I_D = 8\text{ mA}$	3.0		5.0 V
$I_{GSS}$	$V_{GS} = \pm 30\text{ V}_{DC}$ , $V_{DS} = 0$			$\pm 200\text{ nA}$
$I_{DSS}$	$V_{DS} = V_{DSS}$ $V_{GS} = 0\text{ V}$ $T_J = 125^\circ\text{C}$			25 $\mu\text{A}$
				1000 $\mu\text{A}$
$R_{DS(on)}$	$V_{GS} = 10\text{ V}$ , $I_D = 0.5\ I_{D25}$ Pulse test, $t \leq 300\ \mu\text{s}$ , duty cycle $d \leq 2\%$			135 $\text{m}\Omega$

Symbol	Test Conditions	Characteristic Values		
		Min.	Typ.	Max.
$g_{fs}$	$V_{DS} = 20\text{ V}; I_D = 0.5 I_{D25}$ , pulse test	35	53	S
$C_{iss}$	$V_{GS} = 0\text{ V}, V_{DS} = 25\text{ V}, f = 1\text{ MHz}$		8860	pF
$C_{oss}$			850	pF
$C_{rss}$			60	pF
$t_{d(on)}$	$V_{GS} = 10\text{ V}, V_{DS} = 0.5 I_{D25}$ $R_G = 2\ \Omega$ (External)		30	ns
$t_r$			25	ns
$t_{d(off)}$			85	ns
$t_f$			22	ns
$Q_{g(on)}$	$V_{GS} = 10\text{ V}, V_{DS} = 0.5 V_{DSS}, I_D = 0.5 I_{D25}$		150	nC
$Q_{gs}$			50	nC
$Q_{gd}$			50	nC
$R_{thJC}$	TO-264 and PLUS247			0.15 °C/W
$R_{thCs}$			0.15	°C/W

**Source-Drain Diode**

Symbol	Test Conditions	Characteristic Values		
		Min.	Typ.	Max.
$I_S$	$V_{GS} = 0\text{ V}$			48 A
$I_{SM}$	Repetitive			110 A
$V_{SD}$	$I_F = I_S, V_{GS} = 0\text{ V}$ , Pulse test, $t \leq 300\ \mu\text{s}$ , duty cycle $d \leq 2\%$			1.5 V
$t_{rr}$	$I_F = 25\text{ A}, -di/dt = 100\text{ A}/\mu\text{s}$ $V_R = 100\text{ V}$			200 ns
$Q_{RM}$			0.8	$\mu\text{C}$
$I_{RM}$			6.0	A

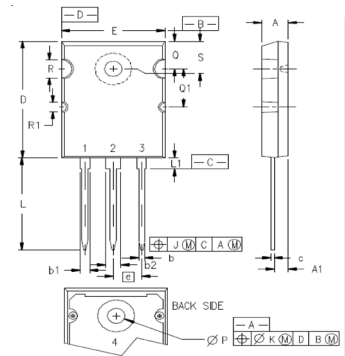
**TO-264 (IXFK) Outline**

- 1 - GATE  
2, 4 - DRAIN (COLLECTOR)  
3 - SOURCE (EMITTER)

SYM	INCHES		MILLIMETERS	
	MIN	MAX	MIN	MAX
A	.185	.209	4.70	5.31
A1	.102	.118	2.59	3.00
b	.037	.055	0.94	1.40
b1	.087	.102	2.21	2.59
b2	.110	.126	2.79	3.20
c	.017	.029	0.43	0.74
D	1.007	1.047	25.58	26.59
E	.760	.799	19.30	20.29
e	.215 BSC		5.46 BSC	
J	.000	.010	0.00	0.25
K	.000	.010	0.00	0.25
L	.779	.842	19.79	21.39
L1	.087	.102	2.21	2.59
ØP	.122	.138	3.10	3.51
Q	.240	.256	6.10	6.50
Q1	.330	.346	8.38	8.79
ØR	.155	.187	3.94	4.75
ØR1	.085	.093	2.16	2.36
S	.243	.253	6.17	6.43

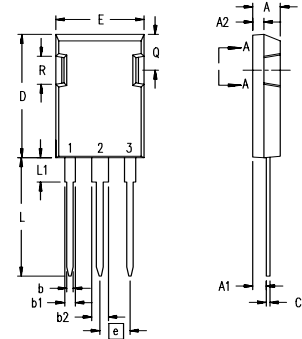
**PLUS 247™ (IXFX) Outline**

- Terminals: 1 - Gate  
2 - Drain (Collector)  
3 - Source (Emitter)  
4 - Drain (Collector)

Dim.	Millimeter		Inches	
	Min.	Max.	Min.	Max.
A	4.83	5.21	.190	.205
A <sub>1</sub>	2.29	2.54	.090	.100
A <sub>2</sub>	1.91	2.16	.075	.085
b	1.14	1.40	.045	.055
b <sub>1</sub>	1.91	2.13	.075	.084
b <sub>2</sub>	2.92	3.12	.115	.123
C	0.61	0.80	.024	.031
D	20.80	21.34	.819	.840
E	15.75	16.13	.620	.635
e	5.45 BSC		.215 BSC	
L	19.81	20.32	.780	.800
L1	3.81	4.32	.150	.170
Q	5.59	6.20	.220	0.244
R	4.32	4.83	.170	.190

IXYS reserves the right to change limits, test conditions, and dimensions.

IXYS MOSFETs and IGBTs are covered by one or more of the following U.S. patents:	4,835,592	4,931,844	5,049,961	5,237,481	6,162,665	6,404,065 B1	6,683,344	6,727,585
	4,850,072	5,017,508	5,063,307	5,381,025	6,259,123 B1	6,534,343	6,710,405B2	6,759,692
	4,881,106	5,034,796	5,187,117	5,486,715	6,306,728 B1	6,583,505	6,710,463	6,771,478 B2

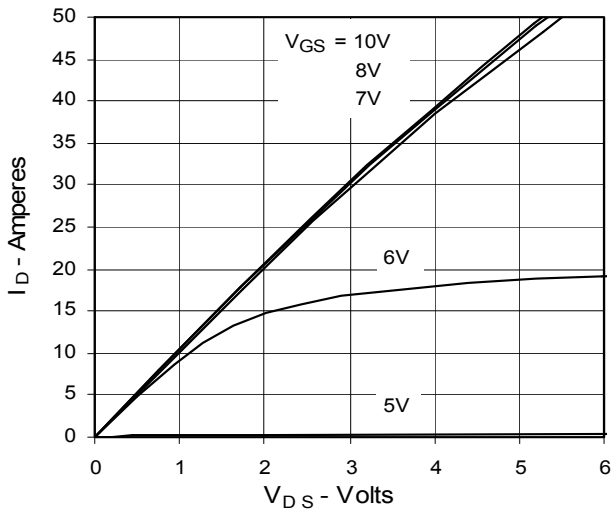
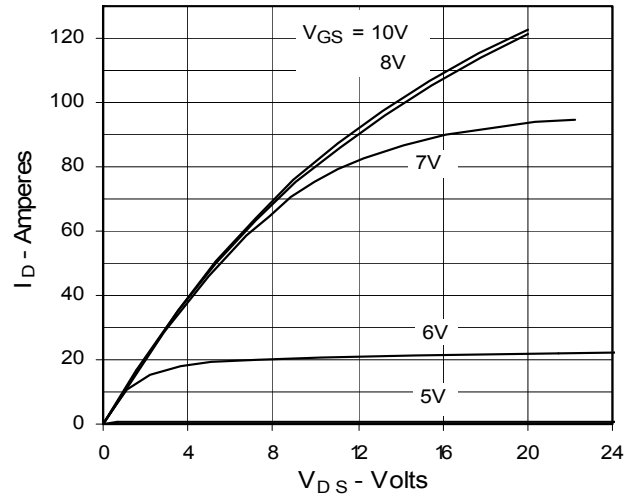
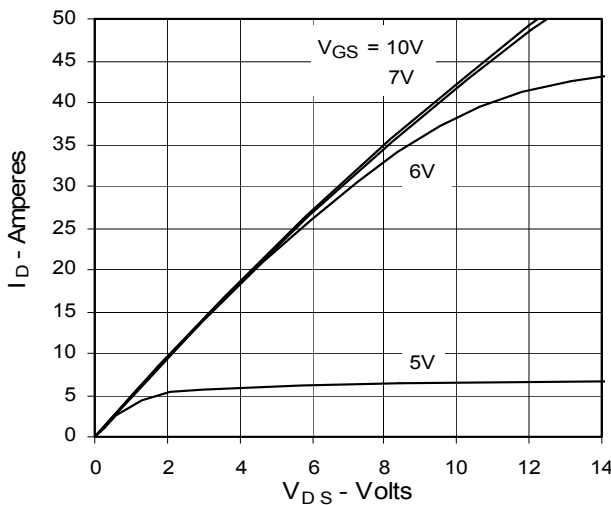
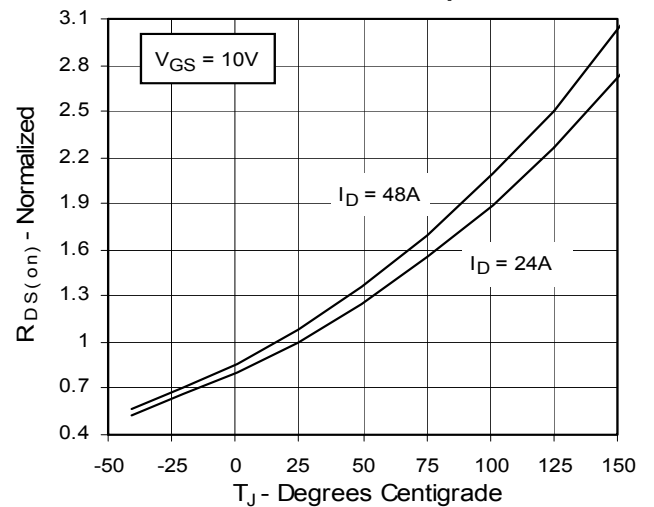
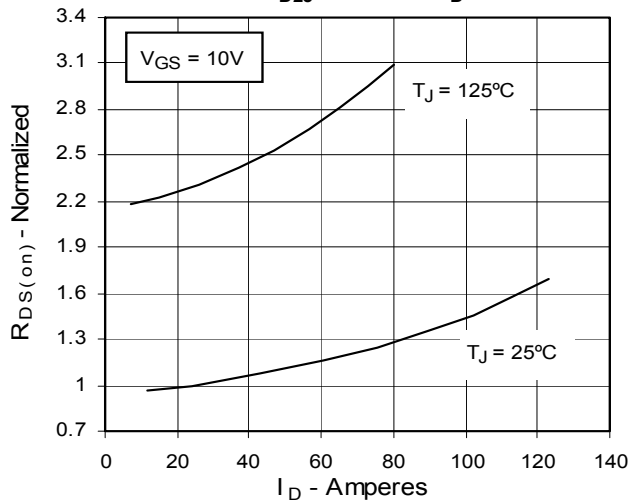
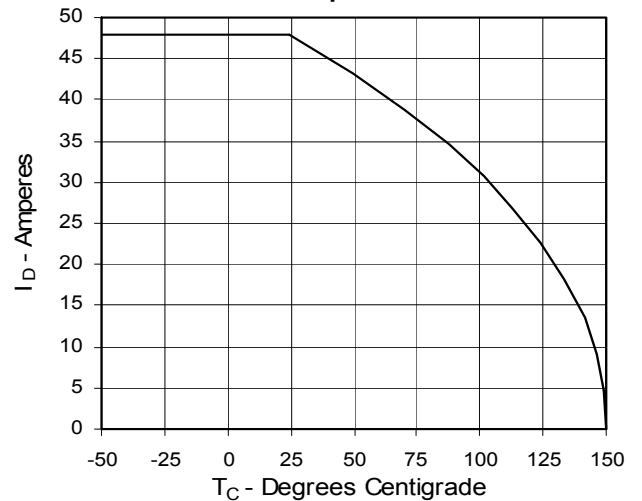
**Fig. 1. Output Characteristics  
@ 25°C**

**Fig. 2. Extended Output Characteristics  
@ 25°C**

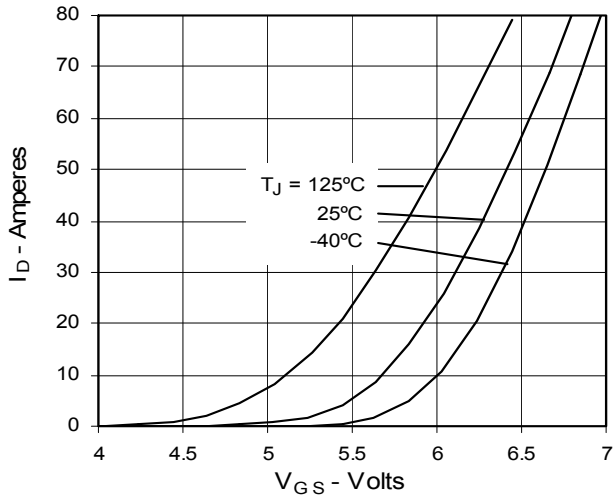
**Fig. 3. Output Characteristics  
@ 125°C**

**Fig. 4.  $R_{DS(on)}$  Normalized to 0.5  $I_{D25}$   
Value vs. Junction Temperature**

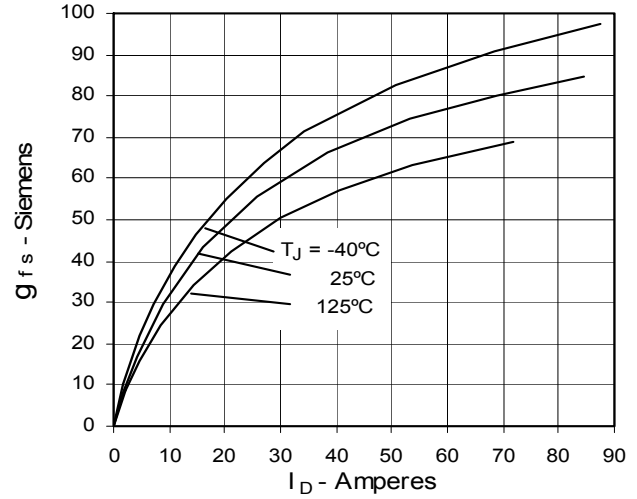
**Fig. 5.  $R_{DS(on)}$  Normalized to  
0.5  $I_{D25}$  Value vs.  $I_D$** 

**Fig. 6. Drain Current vs. Case  
Temperature**

**Fig. 7. Input Admittance**



**Fig. 8. Transconductance**



**Fig. 9. Source Current vs. Source-To-Drain Voltage**

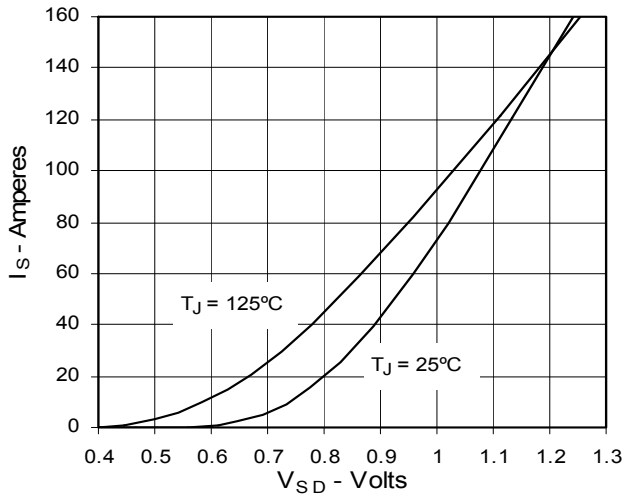

**Fig. 10. Gate Charge**

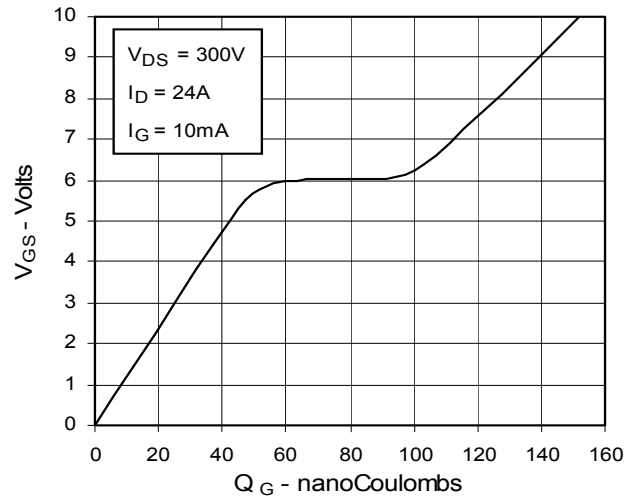

**Fig. 11. Capacitance**

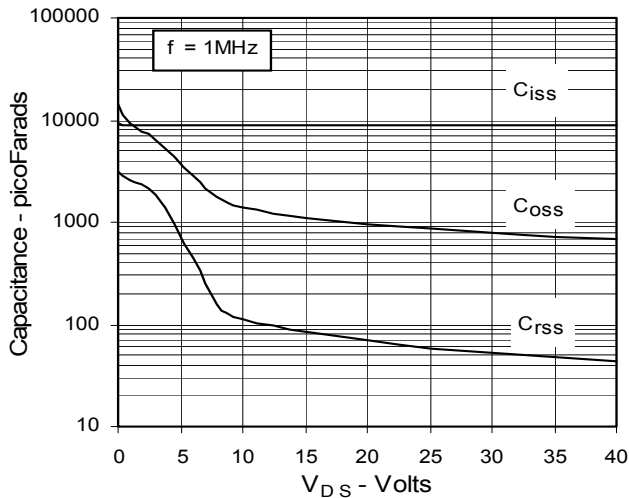

**Fig. 13. Maximum Transient Thermal Resistance**

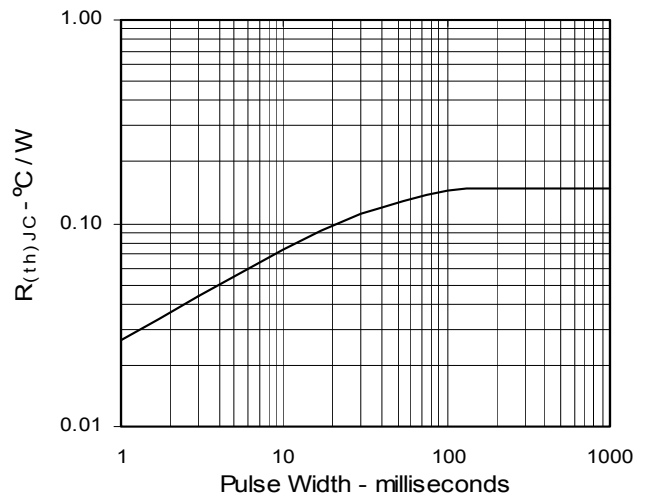



---

Disclaimer Notice - Information furnished is believed to be accurate and reliable. However, users should independently evaluate the suitability of and test each product selected for their own applications. Littelfuse products are not designed for, and may not be used in, all applications. Read complete Disclaimer Notice at [www.littelfuse.com/disclaimer-electronics](http://www.littelfuse.com/disclaimer-electronics).