

# HiPerFET™ Power MOSFETs

**IXFK25N90 IXFX25N90**  
**IXFK26N90 IXFX26N90**

N-Channel Enhancement Mode  
 Avalanche Rated  
 Fast Intrinsic Diode

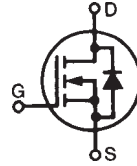

$V_{DSS}$	$I_{D25}$	$R_{DS(on)}$
900V	25A	330mΩ
900V	26A	300mΩ

Symbol	Test Conditions	Maximum Ratings	
$V_{DSS}$	$T_J = 25^\circ\text{C}$ to $150^\circ\text{C}$	900	V
$V_{DGR}$	$T_J = 25^\circ\text{C}$ to $150^\circ\text{C}$ , $R_{GS} = 1\text{M}\Omega$	900	V
$V_{GSS}$	Continuous	$\pm 20$	V
$V_{GSM}$	Transient	$\pm 30$	V
$I_{D25}$	$T_C = 25^\circ\text{C}$	25N90 25	A
$I_{DM}$	$T_C = 25^\circ\text{C}$ , pulse width limited by $T_{JM}$	25N90 100	A
$I_{D25}$	$T_C = 25^\circ\text{C}$	26N90 26	A
$I_{DM}$	$T_C = 25^\circ\text{C}$ , pulse width limited by $T_{JM}$	26N90 104	A
$I_A$	$T_C = 25^\circ\text{C}$	25N90 25	A
		26N90 26	A
$E_{AS}$	$T_C = 25^\circ\text{C}$	3	J
$dV/dt$	$I_s \leq I_{DM}$ , $V_{DD} \leq V_{DSS}$ , $T_J \leq 150^\circ\text{C}$	5	V/ns
$P_D$	$T_C = 25^\circ\text{C}$	560	W
$T_J$		-55 ... +150	$^\circ\text{C}$
$T_{JM}$		150	$^\circ\text{C}$
$T_{stg}$		-55 ... +150	$^\circ\text{C}$
$T_L$	1.6mm (0.062 in.) from case for 10s	300	$^\circ\text{C}$
$T_{SOLD}$	Plastic body for 10s	260	$^\circ\text{C}$
$M_d$	Mounting torque (IXFK)	1.13/10	Nm/lb.in.
$F_c$	Mounting force (IXFX)	20..120 / 4.5..27	N/lb.
<b>Weight</b>	TO-264	10	g
	TO-247	6	g

TO-264

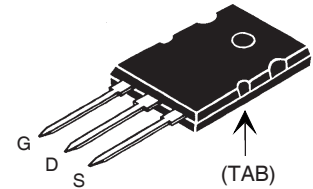

PLUS247

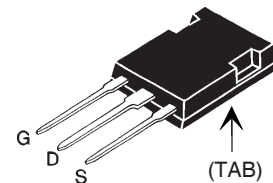

G = Gate      D = Drain  
 S = Source    TAB = Drain

## Features

- International standard packages
- Avalanche Rated
- Low package inductance
- Low  $R_{DS(ON)}$  HDMOS Process
- Fast intrinsic diode

## Advantages

- Easy to mount
- Space savings
- High power density

## Applications:

- Switched-mode and resonant-mode power supplies
- DC-DC Converters
- Battery chargers
- DC choppers
- AC motor drives
- Temperature & lighting controls

Symbol	Test Conditions	Characteristic Values		
		$(T_J = 25^\circ\text{C}$ unless otherwise specified)		
		Min.	Typ.	Max.
$BV_{DSS}$	$V_{GS} = 0\text{V}$ , $I_D = 3\text{mA}$	900		V
$V_{GS(th)}$	$V_{DS} = V_{GS}$ , $I_D = 8\text{mA}$	3.0		5.0 V
$I_{GSS}$	$V_{GS} = \pm 20\text{V}$ , $V_{DS} = 0\text{V}$			$\pm 200$ nA
$I_{DSS}$	$V_{DS} = 0.8 \cdot V_{DSS}$ $V_{GS} = 0\text{V}$ $T_J = 125^\circ\text{C}$			100 $\mu\text{A}$ 2 mA
$R_{DS(on)}$	$V_{GS} = 10\text{V}$ , $I_D = 0.5 \cdot I_{D25}$ , Note 1	25N90 26N90		330 mΩ 300 mΩ

Symbol	Test Conditions	Characteristic Values			
		Min.	Typ.	Max.	
$g_{fs}$	$V_{DS} = 10V, I_D = 0.5 \cdot I_{D25}$ , Note 1	18	28		S
$C_{iss}$	$V_{GS} = 0V, V_{DS} = 25V, f = 1MHz$		8.7	10.8	nF
$C_{oss}$			800	1000	pF
$C_{rss}$			300	375	pF
$t_{d(on)}$	<b>Resistive Switching Times</b>		60		ns
$t_r$	$V_{GS} = 10V, V_{DS} = 0.5 \cdot V_{DSS}, I_D = 0.5 \cdot I_{D25}$		35		ns
$t_{d(off)}$	$R_G = 1\Omega$ (External)		130		ns
$t_f$			24		ns
$Q_{g(on)}$	$V_{GS} = 10V, V_{DS} = 0.5 \cdot V_{DSS}, I_D = 0.5 \cdot I_{D25}$		260		nC
$Q_{gs}$			70		nC
$Q_{gd}$			100		nC
$R_{thJC}$				0.22	$^{\circ}C/W$
$R_{thCS}$			0.15		$^{\circ}C/W$

### Source-Drain Diode

Symbol	Test Conditions	Characteristic Values			
		Min.	Typ.	Max.	
$I_S$	$V_{GS} = 0V$	25N90		25	A
$I_{SM}$	Repetitive, pulse width limited by $T_{JM}$	25N90		100	A
$I_S$	$V_{GS} = 0V$	26N90		26	A
$I_{SM}$	Repetitive, pulse width limited by $T_{JM}$	26N90		104	A
$V_{SD}$	$I_F = I_S, V_{GS} = 0V$ , Note 1			1.5	V
$t_{rr}$	$I_F = I_S, -di/dt = 100A/\mu s$ $V_R = 100V, V_{GS} = 0V$			250	ns
$Q_{RM}$			1.4		$\mu C$
$I_{RM}$			10		A

Note 1: Pulse test,  $t \leq 300\mu s$ ; duty cycle,  $d \leq 2\%$ .

IXYS reserves the right to change limits, test conditions, and dimensions.

IXYS MOSFETs and IGBTs are covered 4,835,592 4,931,844 5,049,961 5,237,481 6,162,665 6,404,065 B1 6,683,344 6,727,585 7,005,734 B2 7,157,338B2  
by one or more of the following U.S. patents: 4,850,072 5,017,508 5,063,307 5,381,025 6,259,123 B1 6,534,343 6,710,405 B2 6,759,692 7,063,975 B2  
4,881,106 5,034,796 5,187,117 5,486,715 6,306,728 B1 6,583,505 6,710,463 6,771,478 B2 7,071,537

### TO-264 (IXFK) Outline

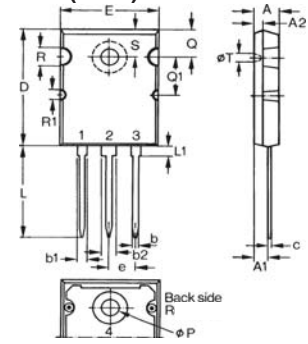

Dim.	Millimeter		Inches	
	Min.	Max.	Min.	Max.
A	4.82	5.13	.190	.202
A1	2.54	2.89	.100	.114
A2	2.00	2.10	.079	.083
b	1.12	1.42	.044	.056
b1	2.39	2.69	.094	.106
b2	2.90	3.09	.114	.122
c	0.53	0.83	.021	.033
D	25.91	26.16	1.020	1.030
E	19.81	19.96	.780	.786
e	5.46 BSC		.215 BSC	
J	0.00	0.25	.000	.010
K	0.00	0.25	.000	.010
L	20.32	20.83	.800	.820
L1	2.29	2.59	.090	.102
P	3.17	3.66	.125	.144
Q	6.07	6.27	.239	.247
Q1	8.38	8.69	.330	.342
R	3.81	4.32	.150	.170
R1	1.78	2.29	.070	.090
S	6.04	6.30	.238	.248
T	1.57	1.83	.062	.072

### PLUS 247™ (IXFX) Outline

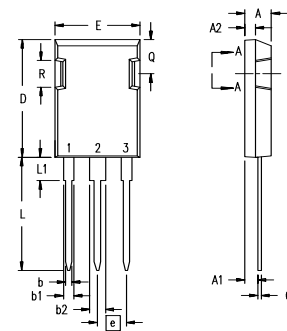

Terminals: 1 - Gate  
2 - Drain (Collector)  
3 - Source (Emitter)

Dim.	Millimeter		Inches	
	Min.	Max.	Min.	Max.
A	4.83	5.21	.190	.205
A1	2.29	2.54	.090	.100
A2	1.91	2.16	.075	.085
b	1.14	1.40	.045	.055
b1	1.91	2.13	.075	.084
b2	2.92	3.12	.115	.123
C	0.61	0.80	.024	.031
D	20.80	21.34	.819	.840
E	15.75	16.13	.620	.635
e	5.45 BSC		.215 BSC	
L	19.81	20.32	.780	.800
L1	3.81	4.32	.150	.170
Q	5.59	6.20	.220	0.244
R	4.32	4.83	.170	.190

Figure 1. Output Characteristics at 25°C

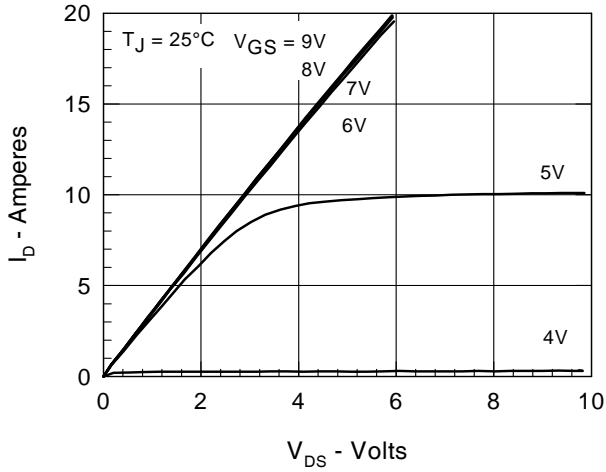

Figure 2. Extended Output Characteristics at 125°C

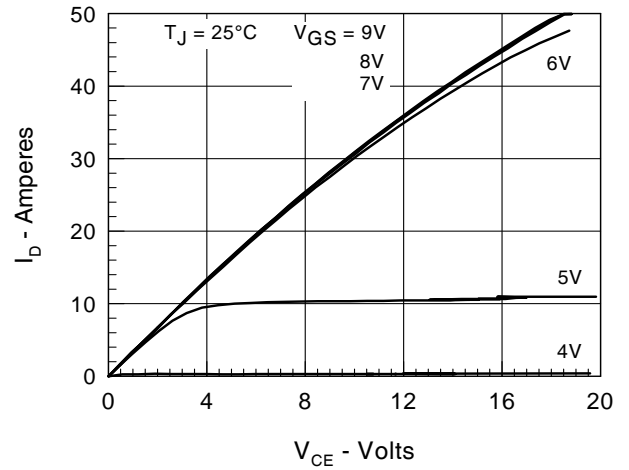

Figure 3.  $R_{DS(on)}$  normalized to 0.5  $I_{D25}$  value vs.  $I_D$

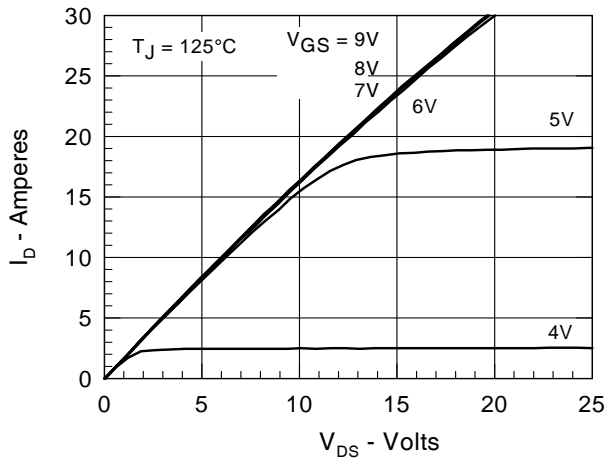

Figure 4. Admittance Curves

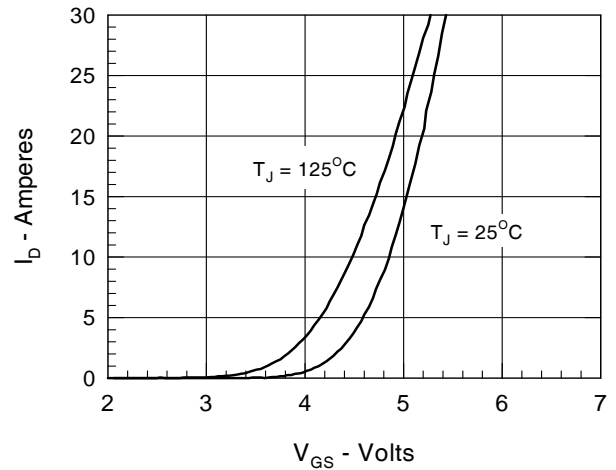

Figure 5.  $R_{DS(on)}$  normalized to 0.5  $I_{D25}$  value vs.  $I_D$

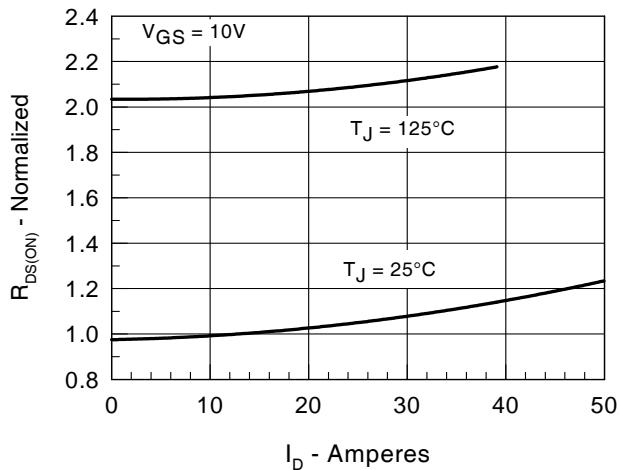

Fig. 6.  $R_{DS(on)}$  Normalized to 0.5  $I_{D25}$  Value vs. Junction Temperature

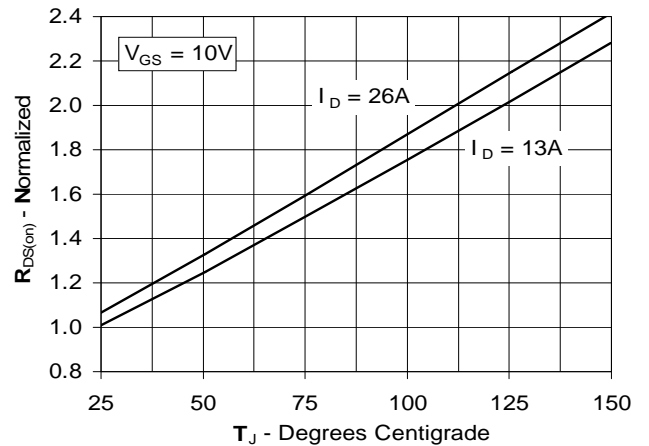

Figure 7. Gate Charge

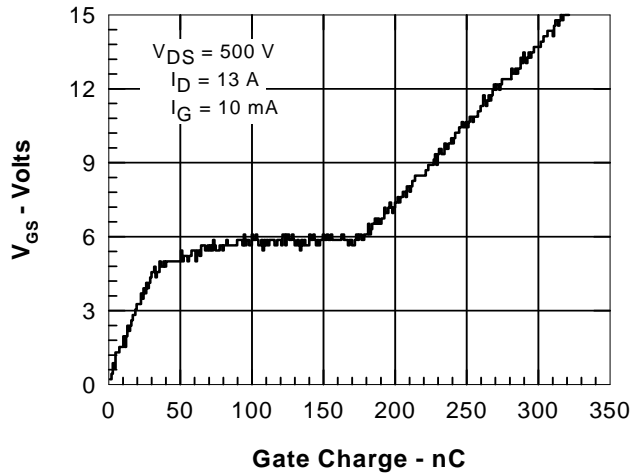

Figure 8. Capacitance Curves

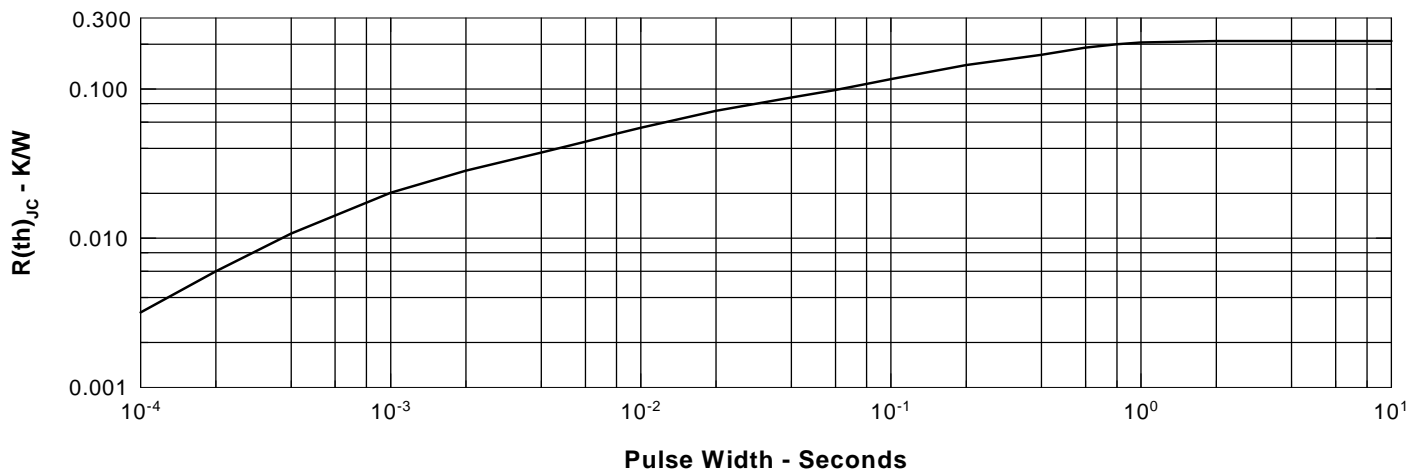
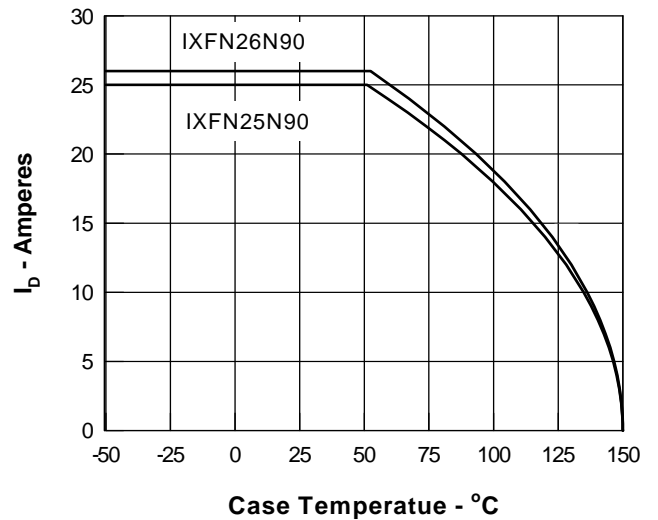
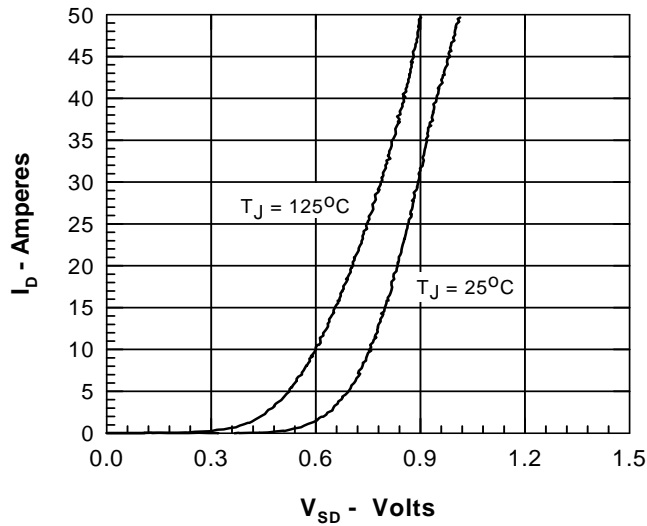
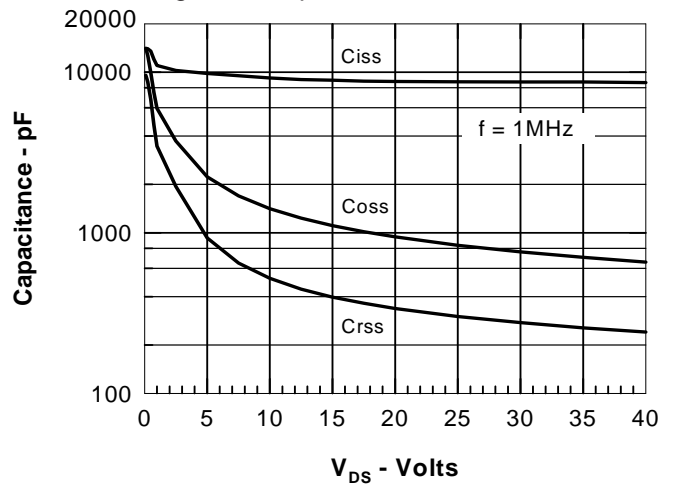

Figure 11. Transient Thermal Resistance

IXYS reserves the right to change limits, test conditions, and dimensions.



---

Disclaimer Notice - Information furnished is believed to be accurate and reliable. However, users should independently evaluate the suitability of and test each product selected for their own applications. Littelfuse products are not designed for, and may not be used in, all applications. Read complete Disclaimer Notice at [www.littelfuse.com/disclaimer-electronics](http://www.littelfuse.com/disclaimer-electronics).