

## Polar3™ HiperFET™ Power MOSFET

N-Channel Enhancement Mode  
Avalanche Rated  
Fast Intrinsic Rectifier

**IXFA20N50P3**  
**IXFP20N50P3**  
**IXFQ20N50P3**  
**IXFH20N50P3**

$V_{DSS} = 500V$   
 $I_{D25} = 20A$   
 $R_{DS(on)} \leq 300m\Omega$

TO-263 (IXFA)

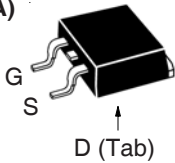

TO-220 (IXFP)

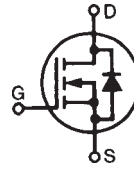
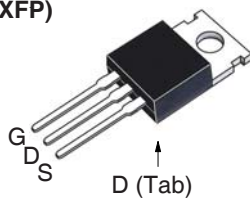

TO-3P (IXFQ)

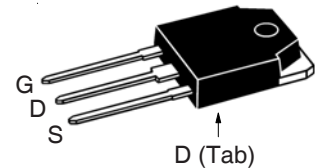

TO-247 (IXFH)

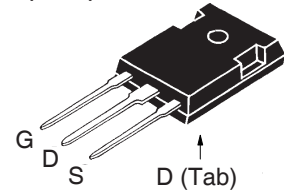

G = Gate      D = Drain  
S = Source    Tab = Drain

| Symbol        | Test Conditions  | Maximum Ratings    |            |
|---------------|--|--------------------|------------|
| $V_{DSS}$     | $T_J = 25^\circ C$ to $150^\circ C$                                | 500                | V          |
| $V_{DGR}$     | $T_J = 25^\circ C$ to $150^\circ C$ , $R_{GS} = 1M\Omega$          | 500                | V          |
| $V_{GSS}$     | Continuous   | $\pm 30$           | V          |
| $V_{GSM}$     | Transient  | $\pm 40$           | V          |
| $I_{D25}$     | $T_C = 25^\circ C$   | 20                 | A          |
| $I_{DM}$      | $T_C = 25^\circ C$ , Pulse Width Limited by $T_{JM}$               | 40                 | A          |
| $I_A$         | $T_C = 25^\circ C$   | 10                 | A          |
| $E_{AS}$      | $T_C = 25^\circ C$   | 300                | mJ         |
| $dv/dt$       | $I_S \leq I_{DM}$ , $V_{DD} \leq V_{DSS}$ , $T_J \leq 150^\circ C$ | 35                 | V/ns       |
| $P_D$         | $T_C = 25^\circ C$   | 380                | W          |
| $T_J$         |  | -55 ... +150       | $^\circ C$ |
| $T_{JM}$      |  | 150                | $^\circ C$ |
| $T_{stg}$     |  | -55 ... +150       | $^\circ C$ |
| $T_L$         | Maximum Lead Temperature for Soldering                             | 300                | $^\circ C$ |
| $T_{SOLD}$    | Plastic Body for 10s   | 260                | $^\circ C$ |
| $F_C$         | Mounting Force (TO-263)  | 10..65 / 2.2..14.6 | N/lb       |
| $M_d$         | Mounting Torque (TO-220, TO-3P & TO-247)                           | 1.13 / 10          | Nm/lb.in   |
| <b>Weight</b> | TO-263   | 2.5                | g          |
|               | TO-220   | 3.0                | g          |
|               | TO-3P  | 5.5                | g          |
|               | TO-247   | 6.0                | g          |

| Symbol       | Test Conditions<br>( $T_J = 25^\circ C$ Unless Otherwise Specified) | Characteristic Values |      |                       |
|--------------|---|-----------------------|------|-----------------------|
|              |   | Min.                  | Typ. | Max.                  |
| $BV_{DSS}$   | $V_{GS} = 0V$ , $I_D = 1mA$   | 500                   |      | V                     |
| $V_{GS(th)}$ | $V_{DS} = V_{GS}$ , $I_D = 1.5mA$                                   | 3.0                   |      | 5.0 V                 |
| $I_{GSS}$    | $V_{GS} = \pm 30V$ , $V_{DS} = 0V$                                  |                       |      | $\pm 100$ nA          |
| $I_{DSS}$    | $V_{DS} = V_{DSS}$ , $V_{GS} = 0V$<br>$T_J = 125^\circ C$           |                       |      | 25 $\mu A$<br>1.25 mA |
| $R_{DS(on)}$ | $V_{GS} = 10V$ , $I_D = 0.5 \cdot I_{D25}$ , Note 1                 |                       |      | 300 m $\Omega$        |

### Features

- Fast Intrinsic Rectifier
- Avalanche Rated
- Low  $R_{DS(ON)}$  and  $Q_G$
- Low Package Inductance

### Advantages

- High Power Density
- Easy to Mount
- Space Savings

### Applications

- Switch-Mode and Resonant-Mode Power Supplies
- DC-DC Converters
- Laser Drivers
- AC and DC Motor Drives
- Robotics and Servo Controls

| Symbol       | Test Conditions<br>( $T_J = 25^\circ\text{C}$ Unless Otherwise Specified)  | Characteristic Values |      |                    |
|--------------|--|-----------------------|------|--------------------|
|              |  | Min.                  | Typ. | Max.               |
| $g_{fs}$     | $V_{DS} = 20\text{V}, I_D = 0.5 \cdot I_{D25}$ , Note 1  | 11                    | 18   | S                  |
| $C_{iss}$    | $V_{GS} = 0\text{V}, V_{DS} = 25\text{V}, f = 1\text{MHz}$   |                       | 1800 | pF                 |
| $C_{oss}$    |  |                       | 230  | pF                 |
| $C_{rss}$    |  |                       | 8.3  | pF                 |
| $R_{Gi}$     | Gate Input Resistance  |                       | 2.3  | $\Omega$           |
| $t_{d(on)}$  | <b>Resistive Switching Times</b><br>$V_{GS} = 10\text{V}, V_{DS} = 0.5 \cdot V_{DSS}, I_D = 0.5 \cdot I_{D25}$<br>$R_G = 5\Omega$ (External) |                       | 10   | ns                 |
| $t_r$        |  |                       | 5    | ns                 |
| $t_{d(off)}$ |  |                       | 43   | ns                 |
| $t_f$        |  |                       | 9    | ns                 |
| $Q_{g(on)}$  | $V_{GS} = 10\text{V}, V_{DS} = 0.5 \cdot V_{DSS}, I_D = 0.5 \cdot I_{D25}$   |                       | 36   | nC                 |
| $Q_{gs}$     |  |                       | 7    | nC                 |
| $Q_{gd}$     |  |                       | 13   | nC                 |
| $R_{thJC}$   | TO-220<br>TO-247 & TO-3P   |                       | 0.36 | $^\circ\text{C/W}$ |
| $R_{thCS}$   |  |                       | 0.50 | $^\circ\text{C/W}$ |
|              |  |                       | 0.25 | $^\circ\text{C/W}$ |

#### Source-Drain Diode

| Symbol   | Test Conditions<br>( $T_J = 25^\circ\text{C}$ Unless Otherwise Specified)                       | Characteristic Values |      |               |
|----------|---|-----------------------|------|---------------|
|          |   | Min.                  | Typ. | Max.          |
| $I_S$    | $V_{GS} = 0\text{V}$  |                       |      | 20 A          |
| $I_{SM}$ | Repetitive, Pulse Width Limited by $T_{JM}$   |                       |      | 80 A          |
| $V_{SD}$ | $I_F = I_S, V_{GS} = 0\text{V}$ , Note 1  |                       |      | 1.4 V         |
| $t_{rr}$ | $I_F = 10\text{A}, -di/dt = 100\text{A}/\mu\text{s}$<br>$V_R = 100\text{V}, V_{GS} = 0\text{V}$ |                       |      | 250 ns        |
| $I_{RM}$ |   |                       | 8.0  | A             |
| $Q_{RM}$ |   |                       | 0.6  | $\mu\text{C}$ |

Note 1. Pulse test,  $t \leq 300\mu\text{s}$ , duty cycle,  $d \leq 2\%$ .

IXYS Reserves the Right to Change Limits, Test Conditions, and Dimensions.

IXYS MOSFETs and IGBTs are covered by one or more of the following U.S. patents:

|           |           |           |           |              |              |              |              |              |             |
|-----------|-----------|-----------|-----------|--------------|--------------|--------------|--------------|--------------|-------------|
| 4,835,592 | 4,931,844 | 5,049,961 | 5,237,481 | 6,162,665    | 6,404,065 B1 | 6,683,344    | 6,727,585    | 7,005,734 B2 | 7,157,338B2 |
| 4,860,072 | 5,017,508 | 5,063,307 | 5,381,025 | 6,259,123 B1 | 6,534,343    | 6,710,405 B2 | 6,759,692    | 7,063,975 B2 |             |
| 4,881,106 | 5,034,796 | 5,187,117 | 5,486,715 | 6,306,728 B1 | 6,583,505    | 6,710,463    | 6,771,478 B2 | 7,071,537    |             |

Fig. 1. Output Characteristics @  $T_J = 25^\circ\text{C}$

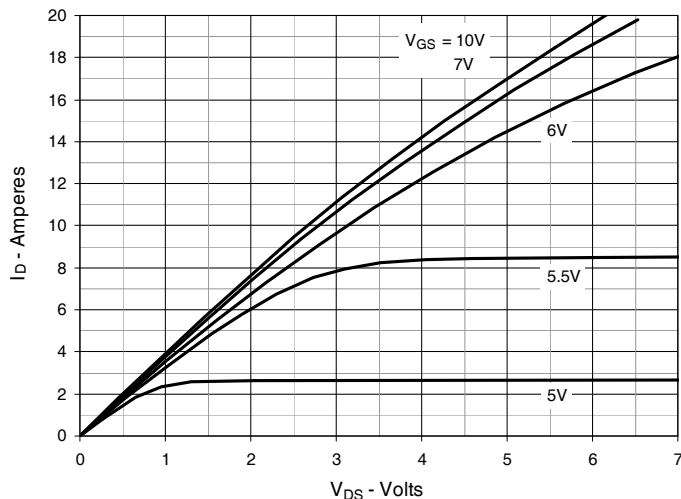

Fig. 2. Extended Output Characteristics @  $T_J = 25^\circ\text{C}$

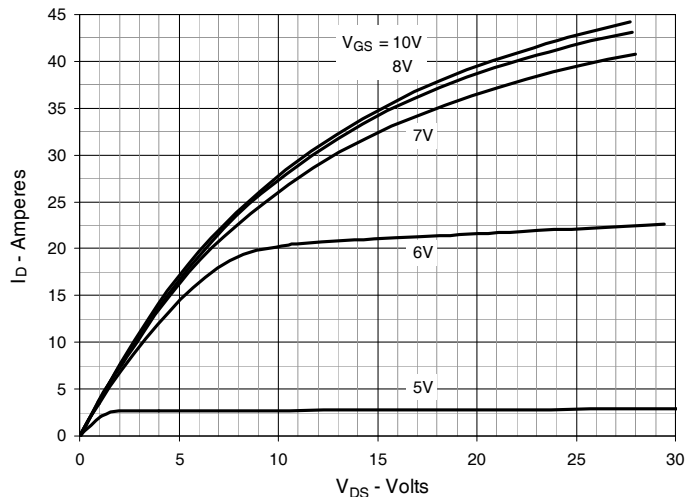

Fig. 3. Output Characteristics @  $T_J = 125^\circ\text{C}$

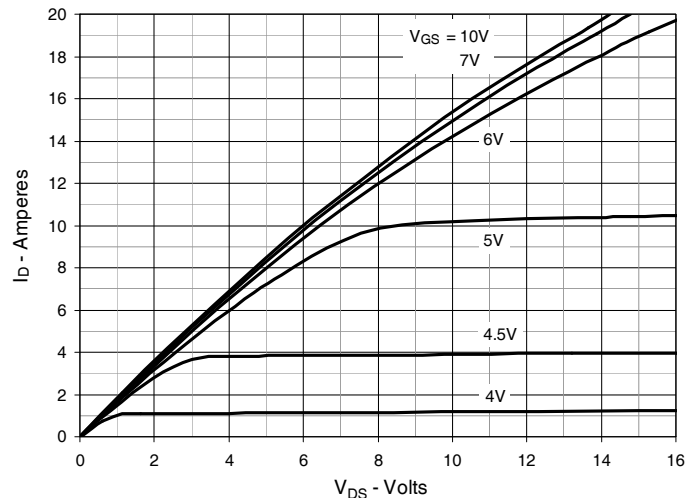

Fig. 4.  $R_{DS(on)}$  Normalized to  $I_D = 10\text{A}$  Value vs. Junction Temperature

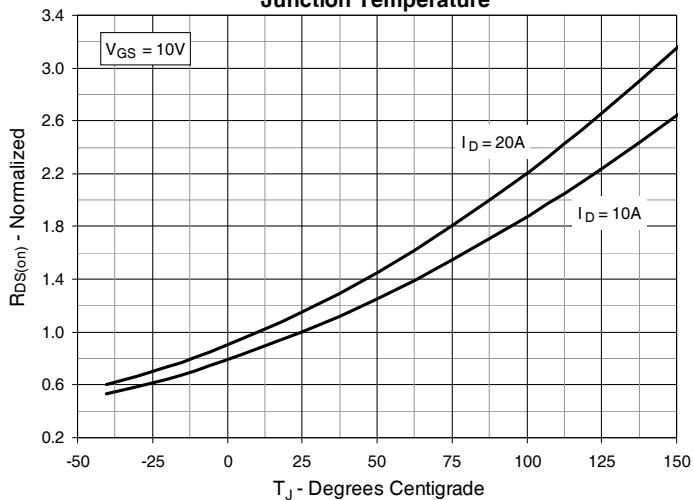

Fig. 5.  $R_{DS(on)}$  Normalized to  $I_D = 10\text{A}$  Value vs. Drain Current

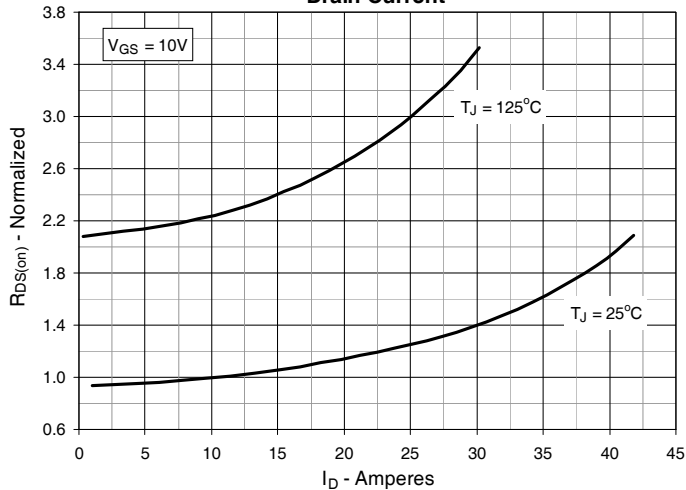

Fig. 6. Maximum Drain Current vs. Case Temperature

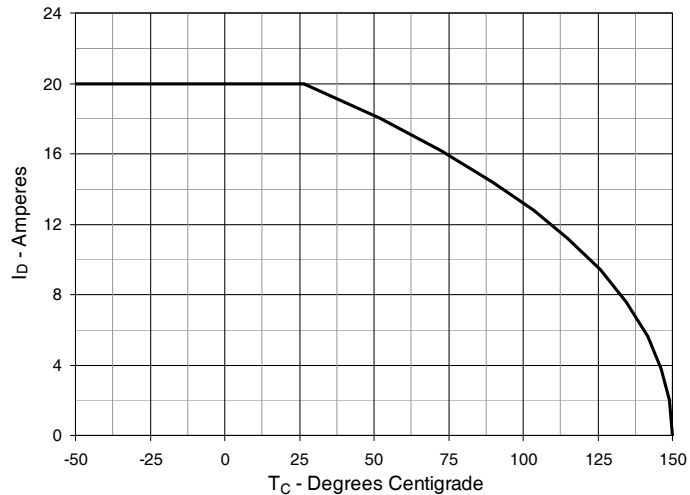

Fig. 7. Input Admittance

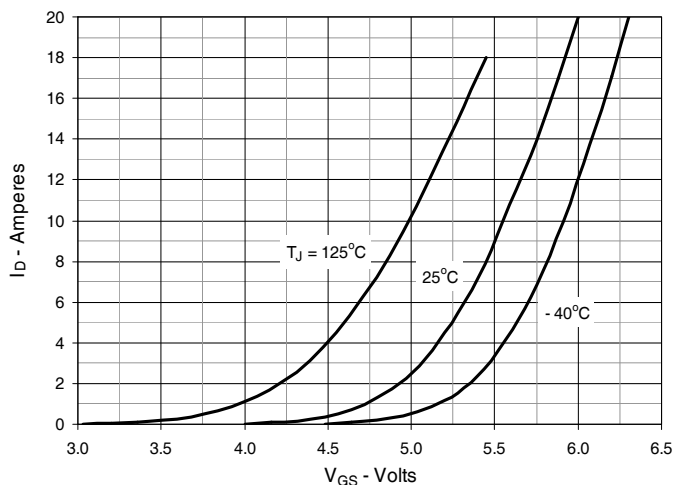

Fig. 8. Transconductance

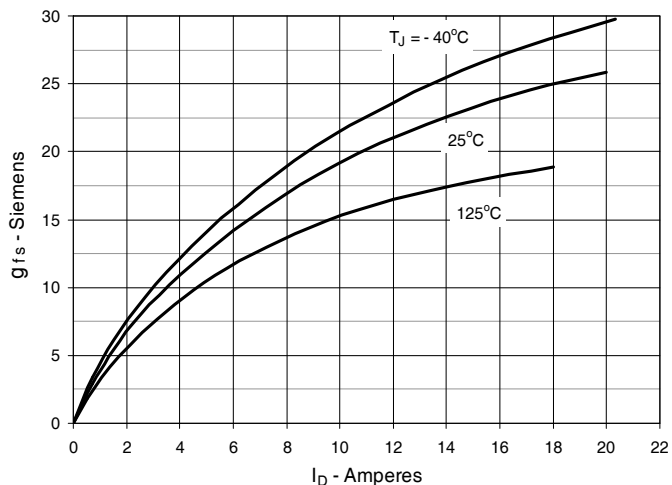

Fig. 9. Forward Voltage Drop of Intrinsic Diode

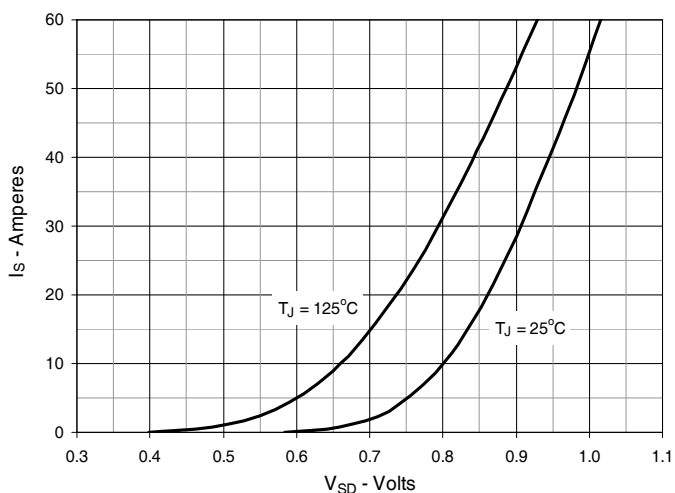

Fig. 10. Gate Charge

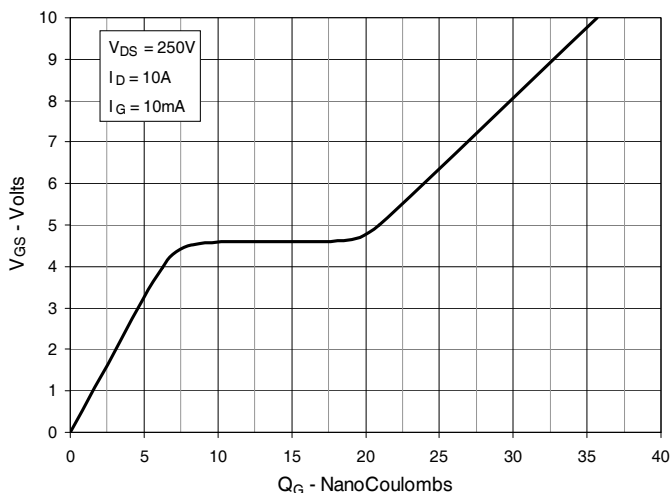

Fig. 11. Capacitance

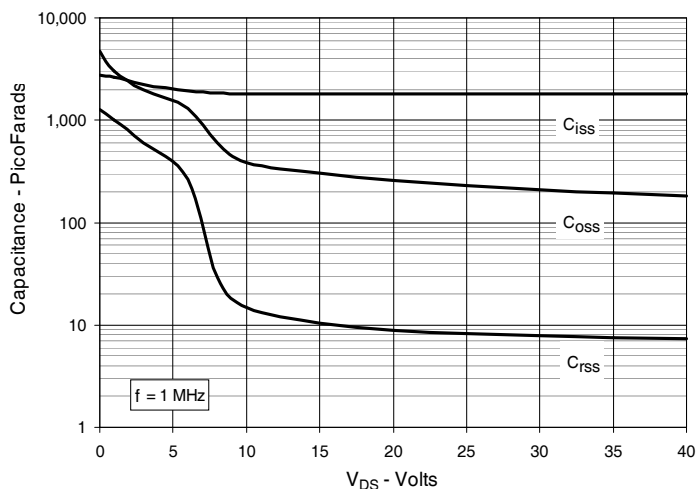

Fig. 12. Forward-Bias Safe Operating Area

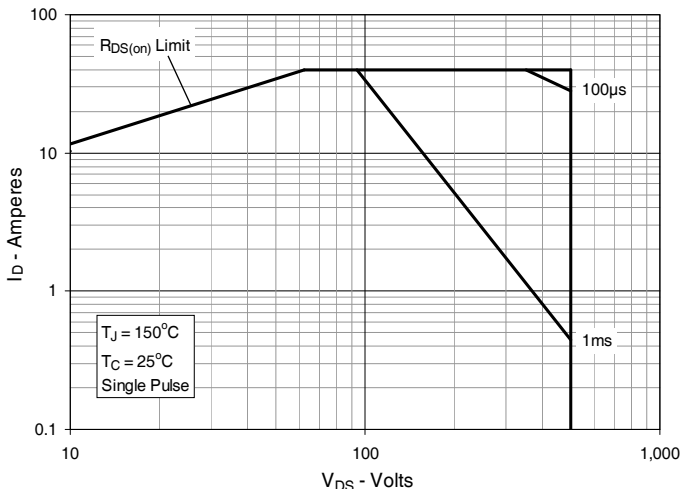
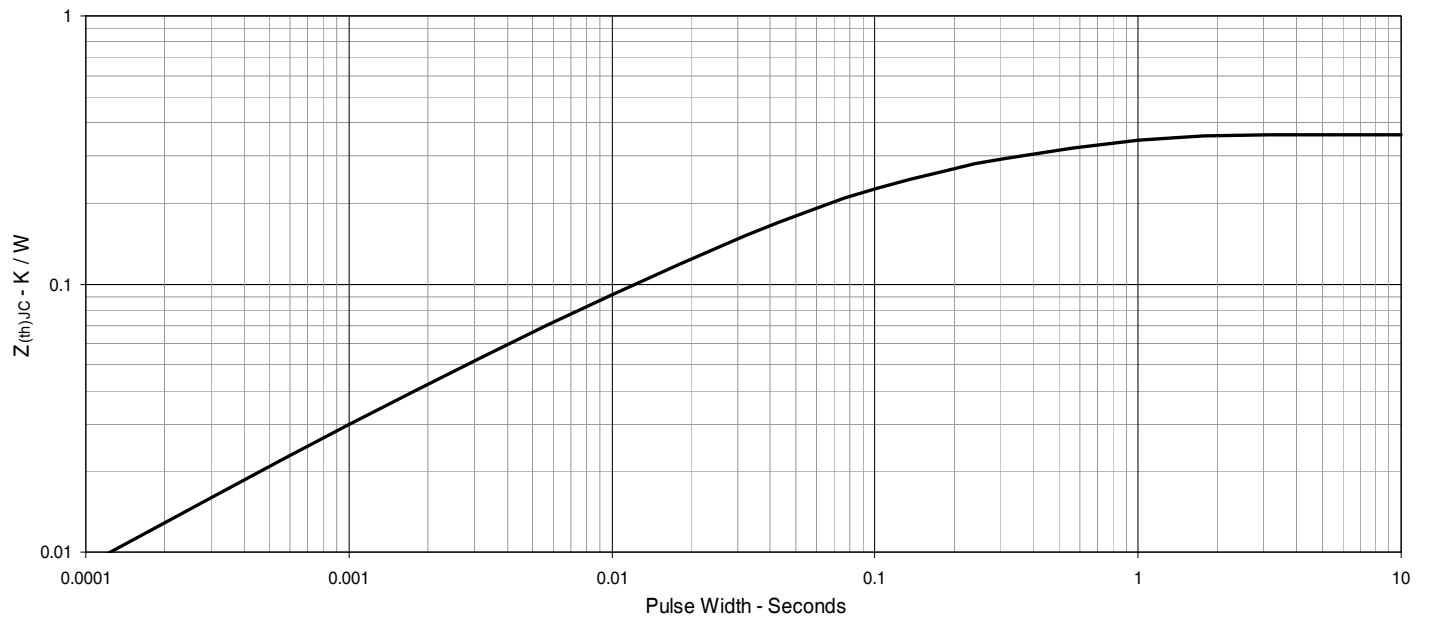
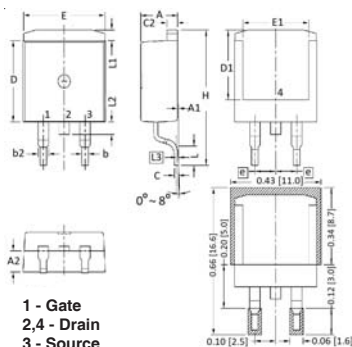

Fig. 13. Maximum Transient Thermal Impedance



### TO-263 Outline



- 1 - Gate
- 2,4 - Drain
- 3 - Source

| SYM | INCHES   |      | MILLIMETER |       |
|-----|----------|------|------------|-------|
|     | MIN      | MAX  | MIN        | MAX   |
| A   | .170     | .185 | 4.30       | 4.70  |
| A1  | .000     | .008 | 0.00       | 0.20  |
| A2  | .091     | .098 | 2.30       | 2.50  |
| b   | .028     | .035 | 0.70       | 0.90  |
| b2  | .046     | .060 | 1.18       | 1.52  |
| C   | .018     | .024 | 0.45       | 0.60  |
| C2  | .049     | .060 | 1.25       | 1.52  |
| D   | .340     | .370 | 8.63       | 9.40  |
| D1  | .300     | .327 | 7.62       | 8.30  |
| E   | .380     | .410 | 9.65       | 10.41 |
| E1  | .270     | .330 | 6.86       | 8.38  |
| e   | .100 BSC |      | 2.54 BSC   |       |
| H   | .580     | .620 | 14.73      | 15.75 |
| L   | .075     | .105 | 1.91       | 2.67  |
| L1  | .039     | .060 | 1.00       | 1.52  |
| L2  | —        | .070 | —          | 1.77  |
| L3  | .010 BSC |      | 0.254 BSC  |       |

### TO-220 Outline

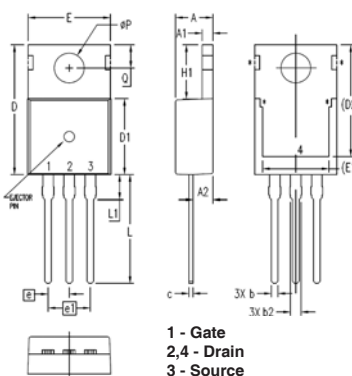

- 1 - Gate
- 2,4 - Drain
- 3 - Source

| SYM  | INCHES   |      | MILLIMETERS |       |
|------|----------|------|-------------|-------|
|      | MIN      | MAX  | MIN         | MAX   |
| A    | .169     | .185 | 4.30        | 4.70  |
| A1   | .047     | .055 | 1.20        | 1.40  |
| A2   | .079     | .106 | 2.00        | 2.70  |
| b    | .024     | .039 | 0.60        | 1.00  |
| b2   | .045     | .057 | 1.15        | 1.45  |
| c    | .014     | .026 | 0.35        | 0.65  |
| D    | .587     | .626 | 14.90       | 15.90 |
| D1   | .335     | .370 | 8.50        | 9.40  |
| (D2) | .500     | .531 | 12.70       | 13.50 |
| E    | .382     | .406 | 9.70        | 10.30 |
| (E1) | .283     | .323 | 7.20        | 8.20  |
| e    | .100 BSC |      | 2.54 BSC    |       |
| e1   | .200 BSC |      | 5.08 BSC    |       |
| H1   | .244     | .268 | 6.20        | 6.80  |
| L    | .492     | .547 | 12.50       | 13.90 |
| L1   | .110     | .154 | 2.80        | 3.90  |
| ∅P   | .134     | .150 | 3.40        | 3.80  |
| Q    | .106     | .126 | 2.70        | 3.20  |

### TO-247 Outline

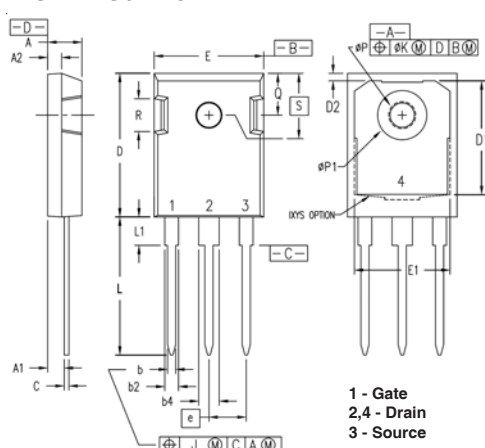

- 1 - Gate
- 2,4 - Drain
- 3 - Source

| SYM | INCHES   |      | MILLIMETERS |       |
|-----|----------|------|-------------|-------|
|     | MIN      | MAX  | MIN         | MAX   |
| A   | .190     | .205 | 4.83        | 5.21  |
| A1  | .090     | .100 | 2.29        | 2.54  |
| A2  | .075     | .085 | 1.91        | 2.16  |
| b   | .045     | .055 | 1.14        | 1.40  |
| b2  | .075     | .087 | 1.91        | 2.20  |
| b4  | .115     | .126 | 2.92        | 3.20  |
| C   | .024     | .031 | 0.61        | 0.80  |
| D   | .819     | .840 | 20.80       | 21.34 |
| D1  | .650     | .690 | 16.51       | 17.53 |
| D2  | .035     | .050 | 0.89        | 1.27  |
| E   | .620     | .635 | 15.75       | 16.13 |
| E1  | .545     | .565 | 13.84       | 14.35 |
| e   | .215 BSC |      | 5.45 BSC    |       |
| J   | —        | .010 | —           | 0.25  |
| K   | —        | .025 | —           | 0.64  |
| L   | .780     | .810 | 19.81       | 20.57 |
| L1  | .150     | .170 | 3.81        | 4.32  |
| ∅P  | .140     | .144 | 3.55        | 3.65  |
| ∅P1 | .275     | .290 | 6.99        | 7.37  |
| Q   | .220     | .244 | 5.59        | 6.20  |
| R   | .170     | .190 | 4.32        | 4.83  |
| S   | .242 BSC |      | 6.15 BSC    |       |

### TO-3P Outline

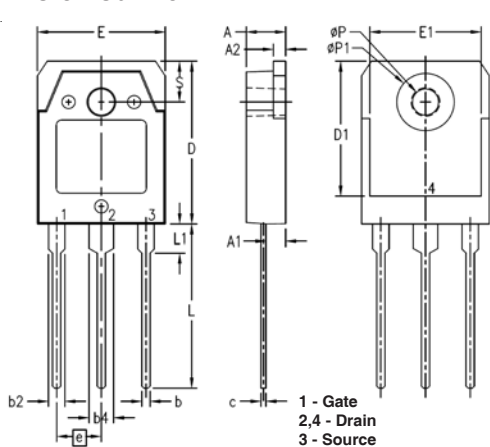

- 1 - Gate
- 2,4 - Drain
- 3 - Source

| SYM | INCHES   |      | MILLIMETERS |       |
|-----|----------|------|-------------|-------|
|     | MIN      | MAX  | MIN         | MAX   |
| A   | .181     | .197 | 4.60        | 5.00  |
| A1  | .087     | 1.02 | 2.20        | 2.60  |
| A2  | .057     | .065 | 1.45        | 1.65  |
| b   | .031     | .047 | 0.80        | 1.20  |
| b2  | .071     | .087 | 1.80        | 2.20  |
| b4  | .110     | .126 | 2.80        | 3.20  |
| c   | .022     | .031 | 0.55        | 0.80  |
| D   | .776     | .791 | 19.70       | 20.10 |
| D1  | .640     | .680 | 16.26       | 17.27 |
| E   | .606     | .622 | 15.40       | 15.80 |
| E1  | .531     | .539 | 13.50       | 13.70 |
| e   | .215 BSC |      | 5.45 BSC    |       |
| L   | .779     | .795 | 19.80       | 20.20 |
| L1  | .130     | .146 | 3.30        | 3.70  |
| ∅P  | .122     | .134 | 3.10        | 3.40  |
| ∅P1 | .272     | .280 | 6.90        | 7.10  |
| S   | .189     | .205 | 4.80        | 5.20  |



---

Disclaimer Notice - Information furnished is believed to be accurate and reliable. However, users should independently evaluate the suitability of and test each product selected for their own applications. Littelfuse products are not designed for, and may not be used in, all applications. Read complete Disclaimer Notice at [www.littelfuse.com/disclaimer-electronics](http://www.littelfuse.com/disclaimer-electronics).