

Depletion Mode MOSFET

IXTA6N50D2
IXTP6N50D2
IXTH6N50D2

$V_{DSX} = 500V$
 $I_{D(on)} \geq 6A$
 $R_{DS(on)} \leq 550m\Omega$

N-Channel

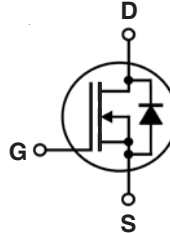

| Symbol | Test Conditions | Maximum Ratings | |
|---------------|-------------------------------------|-----------------|------------|
| V_{DSX} | $T_J = 25^\circ C$ to $150^\circ C$ | 500 | V |
| V_{GSX} | Continuous | ± 20 | V |
| V_{GSM} | Transient | ± 30 | V |
| P_D | $T_C = 25^\circ C$ | 300 | W |
| T_J | | - 55 ... +150 | $^\circ C$ |
| T_{JM} | | 150 | $^\circ C$ |
| T_{stg} | | - 55 ... +150 | $^\circ C$ |
| T_L | 1.6mm (0.062 in.) from Case for 10s | 300 | $^\circ C$ |
| T_{SOLD} | Plastic Body for 10s | 260 | $^\circ C$ |
| M_d | Mounting Torque (TO-220 & TO-247) | 1.13 / 10 | Nm/lb.in. |
| Weight | TO-263 | 2.5 | g |
| | TO-220 | 3.0 | g |
| | TO-247 | 6.0 | g |

| Symbol | Test Conditions ($T_J = 25^\circ C$, Unless Otherwise Specified) | Characteristic Values | | |
|----------------|---|-----------------------|------|-------------------------|
| | | Min. | Typ. | Max. |
| BV_{DSX} | $V_{GS} = -5V, I_D = 250\mu A$ | 500 | | V |
| $V_{GS(off)}$ | $V_{DS} = 25V, I_D = 250\mu A$ | - 2.5 | | V |
| I_{GSX} | $V_{GS} = \pm 20V, V_{DS} = 0V$ | | | ± 100 nA |
| $I_{DSX(off)}$ | $V_{DS} = V_{DSX}, V_{GS} = -5V$ $T_J = 125^\circ C$ | | | 5 μA 50 μA |
| $R_{DS(on)}$ | $V_{GS} = 0V, I_D = 3A, \text{Note 1}$ | | | 550 m Ω |
| $I_{D(on)}$ | $V_{GS} = 0V, V_{DS} = 25V, \text{Note 1}$ | 6 | | A |

TO-263 AA (IXTA)

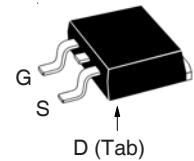

TO-220AB (IXTP)

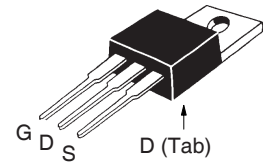

TO-247 (IXTH)

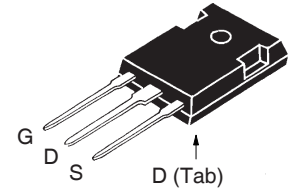

G = Gate D = Drain
S = Source Tab = Drain

Features

- Normally ON Mode
- International Standard Packages
- Molding Epoxies Meet UL 94 V-0 Flammability Classification

Advantages

- Easy to Mount
- Space Savings
- High Power Density

Applications

- Audio Amplifiers
- Start-up Circuits
- Protection Circuits
- Ramp Generators
- Current Regulators
- Active Loads

| Symbol | Test Conditions ($T_J = 25^\circ\text{C}$, Unless Otherwise Specified) | Characteristic Values | | |
|--------------|---|-----------------------|------|--------------------|
| | | Min. | Typ. | Max. |
| g_{fs} | $V_{DS} = 30\text{V}$, $I_D = 3\text{A}$, Note 1 | 2.8 | 4.5 | S |
| C_{iss} | $V_{GS} = -10\text{V}$, $V_{DS} = 25\text{V}$, $f = 1\text{MHz}$ | | 2800 | pF |
| C_{oss} | | | 255 | pF |
| C_{rss} | | | 64 | pF |
| $t_{d(on)}$ | Resistive Switching Times $V_{GS} = \pm 5\text{V}$, $V_{DS} = 250\text{V}$, $I_D = 3\text{A}$ $R_G = 2.4\Omega$ (External) | | 28 | ns |
| t_r | | | 72 | ns |
| $t_{d(off)}$ | | | 82 | ns |
| t_f | | | 43 | ns |
| $Q_{g(on)}$ | $V_{GS} = \pm 5\text{V}$, $V_{DS} = 250\text{V}$, $I_D = 3\text{A}$ | | 96 | nC |
| Q_{gs} | | | 11 | nC |
| Q_{gd} | | | 48 | nC |
| R_{thJC} | TO-220 TO-247 | | 0.50 | $^\circ\text{C/W}$ |
| R_{thCS} | | | 0.21 | $^\circ\text{C/W}$ |

Safe-Operating-Area Specification

| Symbol | Test Conditions | Characteristic Values | | |
|--------|--|-----------------------|------|------|
| | | Min. | Typ. | Max. |
| SOA | $V_{DS} = 400\text{V}$, $I_D = 0.45\text{A}$, $T_C = 75^\circ\text{C}$, $T_p = 5\text{s}$ | 180 | | W |

Source-Drain Diode

| Symbol | Test Conditions ($T_J = 25^\circ\text{C}$, Unless Otherwise Specified) | Characteristic Values | | |
|----------|--|-----------------------|------|---------------|
| | | Min. | Typ. | Max. |
| V_{SD} | $I_F = 6\text{A}$, $V_{GS} = -10\text{V}$, Note 1 | | 0.8 | 1.3 V |
| t_{rr} | $I_F = 3\text{A}$, $-di/dt = 100\text{A}/\mu\text{s}$ $V_R = 100\text{V}$, $V_{GS} = -10\text{V}$ | | 350 | ns |
| I_{RM} | | | 16 | A |
| Q_{RM} | | | 2.8 | μC |

Note 1. Pulse test, $t \leq 300\mu\text{s}$, duty cycle, $d \leq 2\%$.

TO-263 Outline

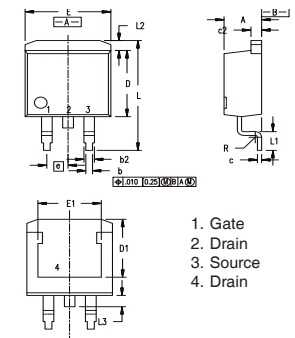

1. Gate
2. Drain
3. Source
4. Drain

| Dim. | Millimeter | | Inches | |
|------|------------|-------|--------|------|
| | Min. | Max. | Min. | Max. |
| A | 4.06 | 4.83 | .160 | .190 |
| b | 0.51 | 0.99 | .020 | .039 |
| b2 | 1.14 | 1.40 | .045 | .055 |
| c | 0.40 | 0.74 | .016 | .029 |
| c2 | 1.14 | 1.40 | .045 | .055 |
| D | 8.64 | 9.65 | .340 | .380 |
| D1 | 8.00 | 8.89 | .280 | .320 |
| E | 9.65 | 10.41 | .380 | .405 |
| E1 | 6.22 | 8.13 | .270 | .320 |
| e | 2.54 | BSC | .100 | BSC |
| L | 14.61 | 15.88 | .575 | .625 |
| L1 | 2.29 | 2.79 | .090 | .110 |
| L2 | 1.02 | 1.40 | .040 | .055 |
| L3 | 1.27 | 1.78 | .050 | .070 |

TO-220 Outline

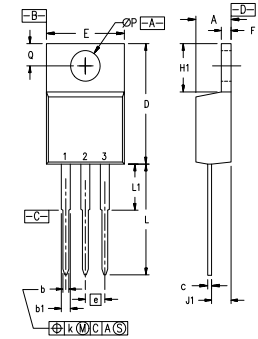

Pins: 1 - Gate
2 - Drain
3 - Source

| SYM | INCHES | | MILLIMETERS | |
|-----|----------|------|-------------|-------|
| | MIN | MAX | MIN | MAX |
| A | .170 | .190 | 4.32 | 4.83 |
| b | .025 | .040 | 0.64 | 1.02 |
| b1 | .045 | .065 | 1.15 | 1.65 |
| c | .014 | .022 | 0.35 | 0.56 |
| D | .580 | .630 | 14.73 | 16.00 |
| E | .390 | .420 | 9.91 | 10.66 |
| e | .100 BSC | | 2.54 BSC | |
| F | .045 | .055 | 1.14 | 1.40 |
| H1 | .230 | .270 | 5.85 | 6.85 |
| J1 | .090 | .110 | 2.29 | 2.79 |
| k | 0 | .015 | 0 | 0.38 |
| L | .500 | .550 | 12.70 | 13.97 |
| L1 | .110 | .230 | 2.79 | 5.84 |
| ØP | .139 | .161 | 3.53 | 4.08 |
| Q | .100 | .125 | 2.54 | 3.18 |

TO-247 Outline

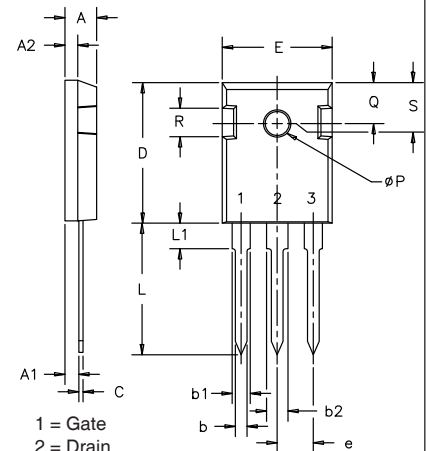

| SYM | INCHES | | MILLIMETERS | |
|-----|----------|------|-------------|-------|
| | MIN | MAX | MIN | MAX |
| A | .185 | .209 | 4.7 | 5.3 |
| A1 | .087 | .102 | 2.2 | 2.54 |
| A2 | .059 | .098 | 2.2 | 2.6 |
| b | .040 | .055 | 1.0 | 1.4 |
| b1 | .065 | .084 | 1.65 | 2.13 |
| b2 | .113 | .123 | 2.87 | 3.12 |
| C | .016 | .031 | .4 | .8 |
| D | .819 | .845 | 20.80 | 21.46 |
| E | .610 | .640 | 15.75 | 16.26 |
| e | .215 BSC | | 5.45 BSC | |
| L | .780 | .800 | 19.81 | 20.32 |
| L1 | | .177 | | 4.50 |
| ØP | .140 | .144 | 3.55 | 3.65 |
| Q | .212 | .244 | 5.4 | 6.2 |
| R | .170 | .216 | 4.32 | 5.49 |
| S | .242 BSC | | 6.15 BSC | |

IXYS Reserves the Right to Change Limits, Test Conditions, and Dimensions.

| | | | | | | | | | | |
|--|-----------|-----------|-----------|-----------|--------------|--------------|--------------|--------------|--------------|-------------|
| IXYS MOSFETs and IGBTs are covered by one or more of the following U.S. patents: | 4,835,592 | 4,931,844 | 5,049,961 | 5,237,481 | 6,162,665 | 6,404,065 B1 | 6,683,344 | 6,727,585 | 7,005,734 B2 | 7,157,338B2 |
| | 4,850,072 | 5,017,508 | 5,063,307 | 5,381,025 | 6,259,123 B1 | 6,534,343 | 6,710,405 B2 | 6,759,692 | 7,063,975 B2 | |
| | 4,881,106 | 5,034,796 | 5,187,117 | 5,486,715 | 6,306,728 B1 | 6,583,505 | 6,710,463 | 6,771,478 B2 | 7,071,537 | |

Fig. 1. Output Characteristics @ $T_J = 25^\circ\text{C}$

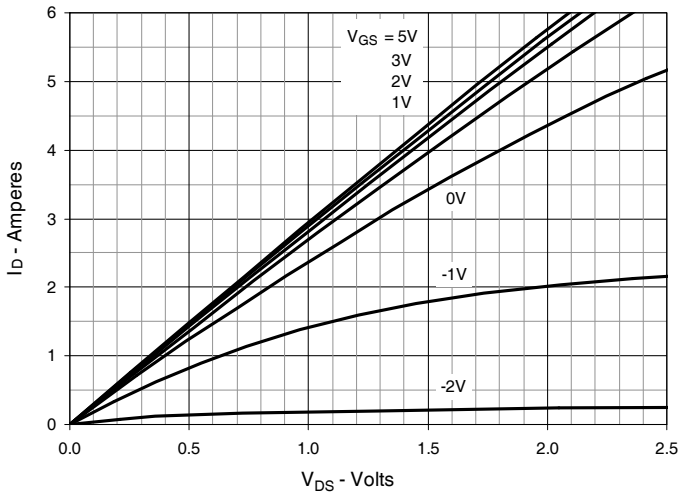

Fig. 2. Extended Output Characteristics @ $T_J = 25^\circ\text{C}$

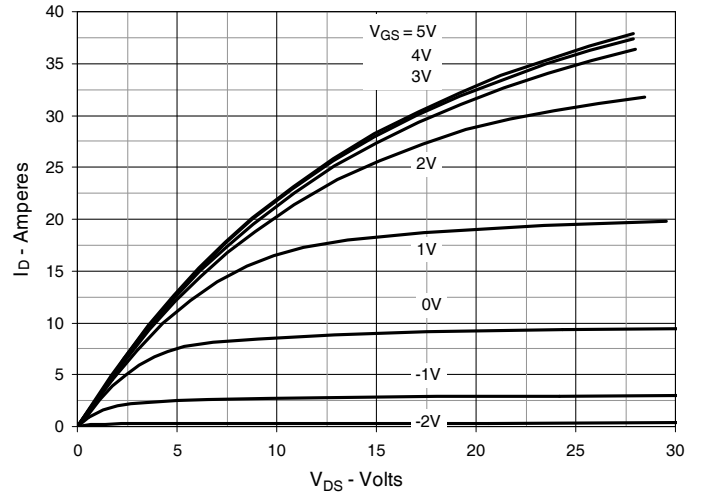

Fig. 3. Output Characteristics @ $T_J = 125^\circ\text{C}$

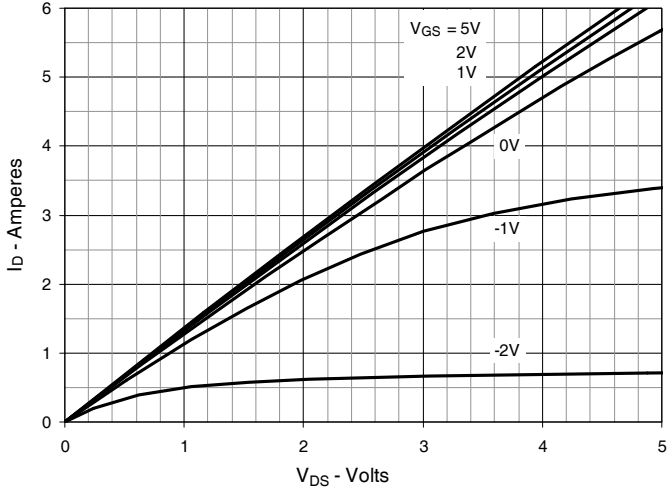

Fig. 4. Drain Current @ $T_J = 25^\circ\text{C}$

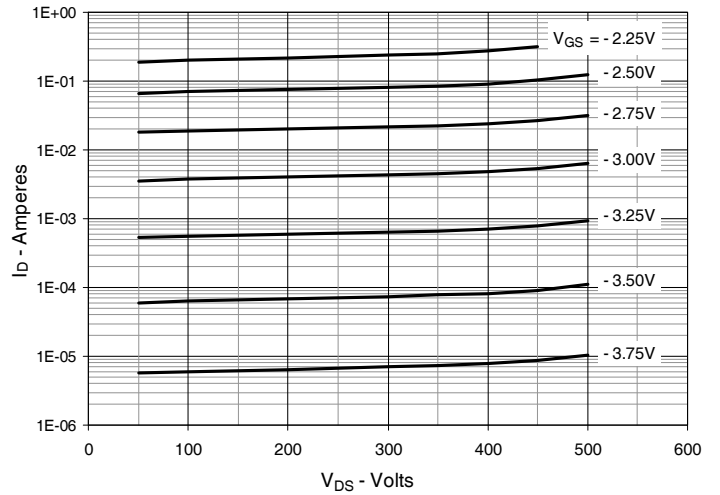

Fig. 5. Drain Current @ $T_J = 100^\circ\text{C}$

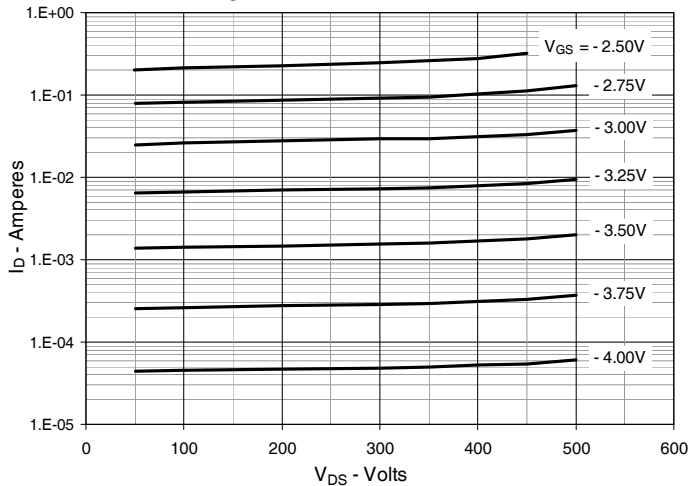

Fig. 6. Dynamic Output Resistance vs. Gate Voltage

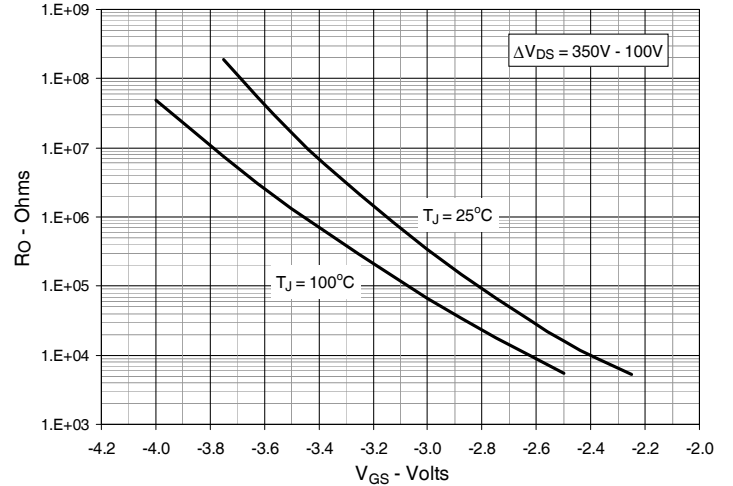

Fig. 7. Normalized $R_{DS(on)}$ vs. Junction Temperature

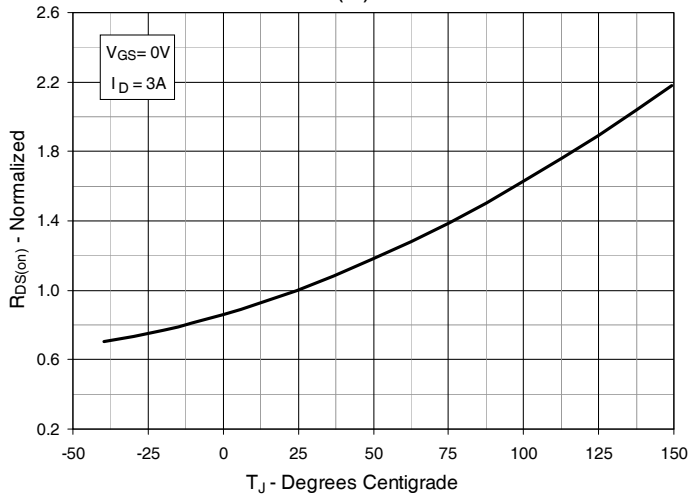

Fig. 8. $R_{DS(on)}$ Normalized to $I_D = 3A$ Value vs. Drain Current

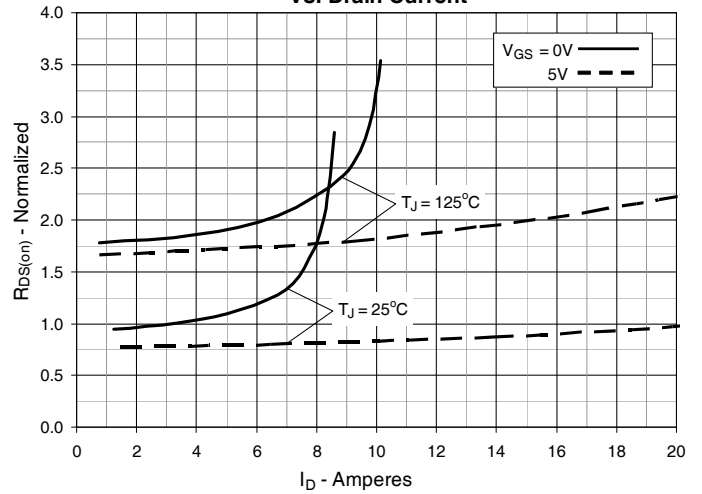

Fig. 9. Input Admittance

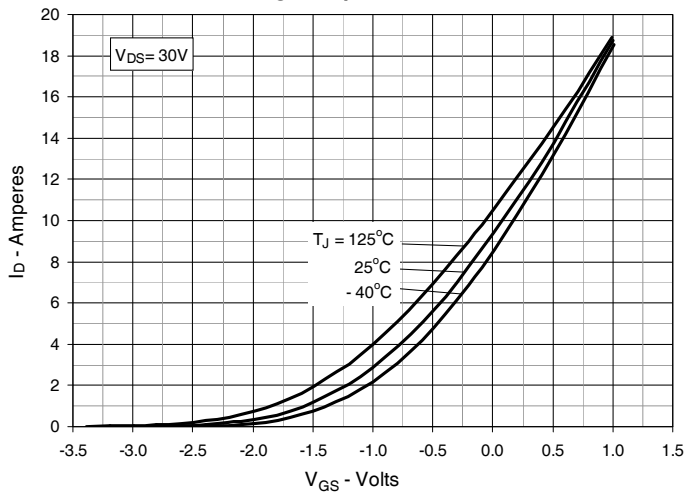

Fig. 10. Transconductance

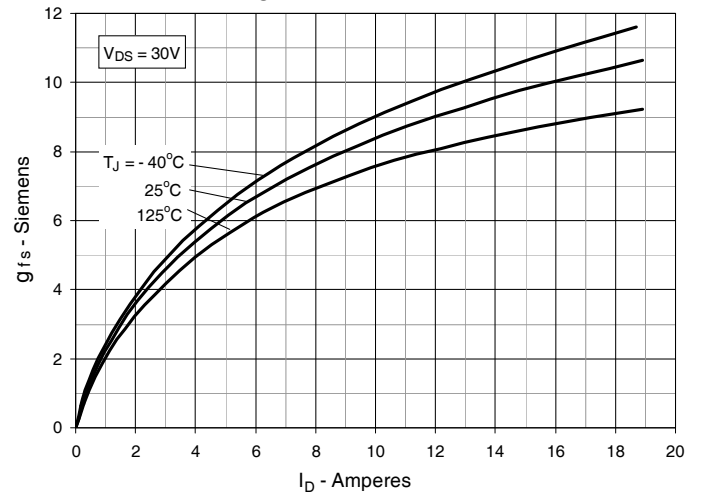

Fig. 11. Breakdown and Threshold Voltages vs. Junction Temperature

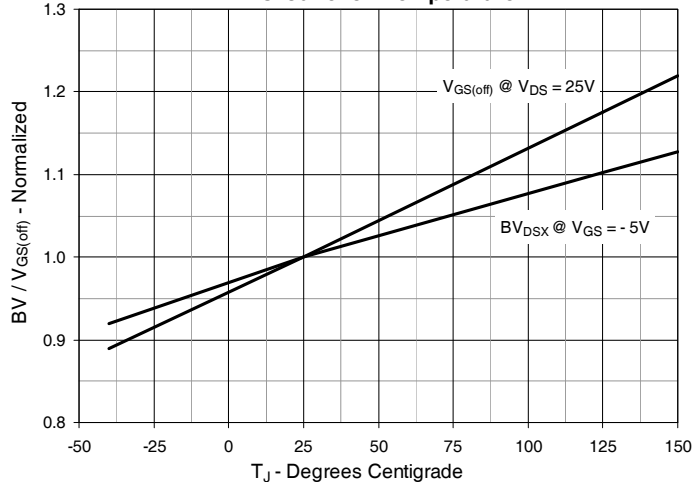

Fig. 12. Forward Voltage Drop of Intrinsic Diode

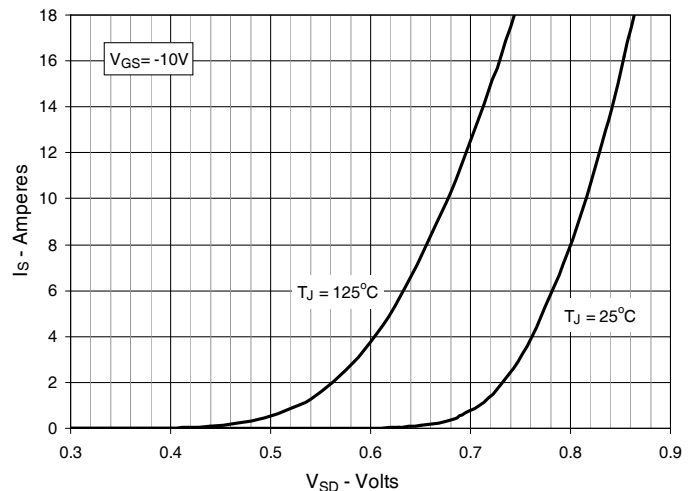

Fig. 13. Capacitance

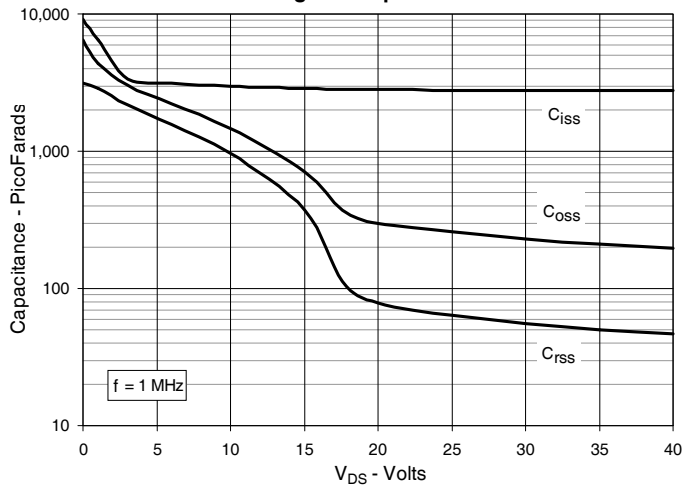

Fig. 14. Gate Charge

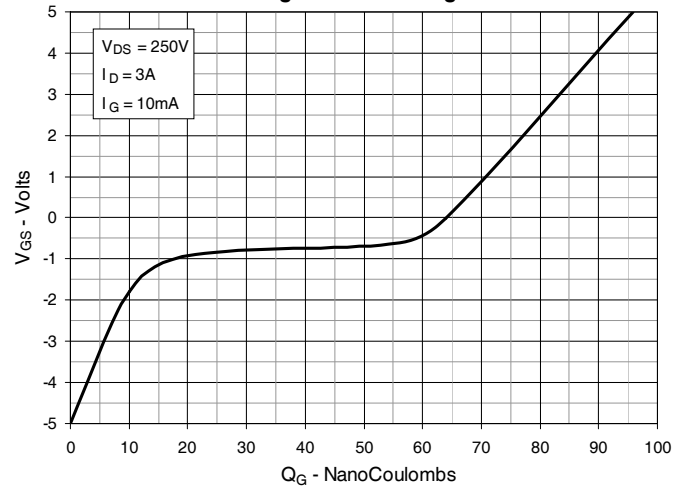

Fig. 15. Forward-Bias Safe Operating Area
@ T_C = 25°C

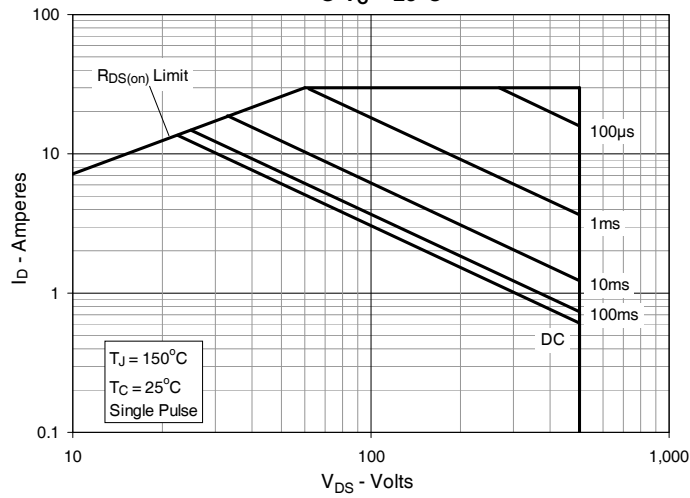

Fig. 16. Forward-Bias Safe Operating Area
@ T_C = 75°C

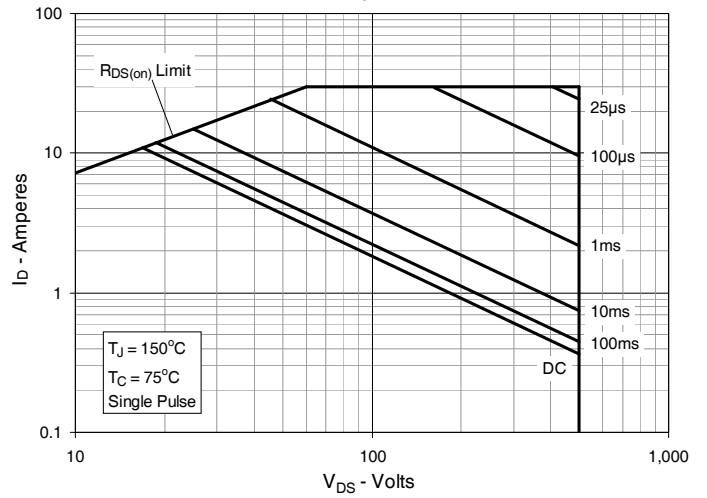
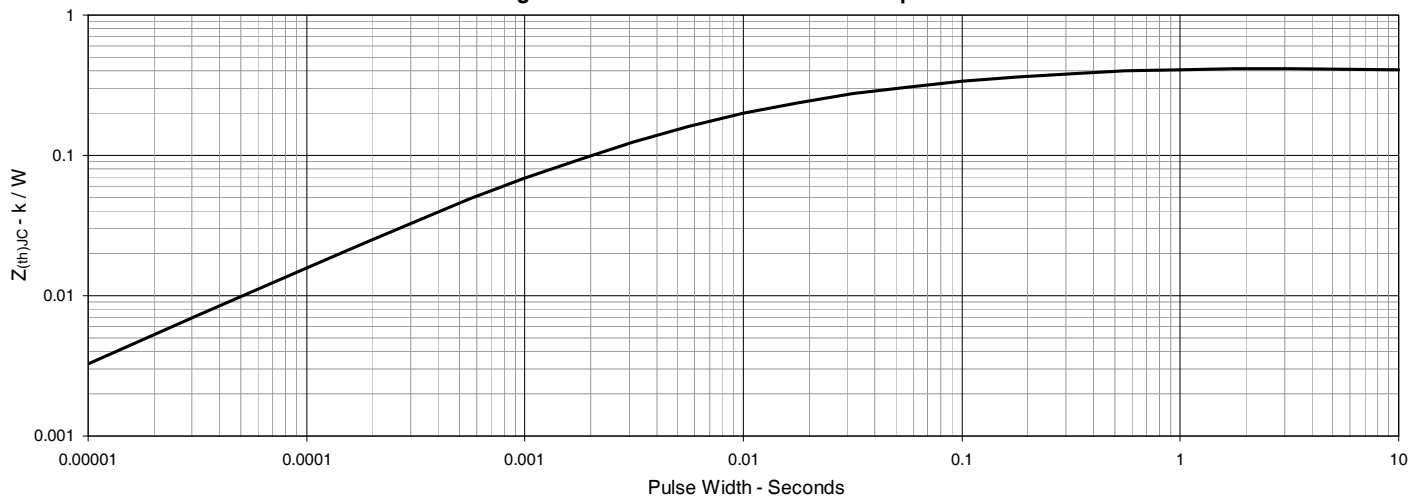

Fig. 17. Maximum Transient Thermal Impedance





Disclaimer Notice - Information furnished is believed to be accurate and reliable. However, users should independently evaluate the suitability of and test each product selected for their own applications. Littelfuse products are not designed for, and may not be used in, all applications. Read complete Disclaimer Notice at www.littelfuse.com/disclaimer-electronics.