

1200V XPT™ GenX4™ IGBT

IXYT55N120A4HV

$V_{CES} = 1200V$
 $I_{C110} = 55A$
 $V_{CE(sat)} \leq 1.8V$
 $t_{fi(typ)} = 270ns$

Ultra Low-Vsat PT IGBT for
up to 5kHz Switching

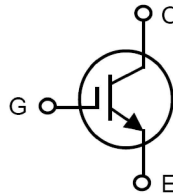

TO-268HV
(IXYT..HV)

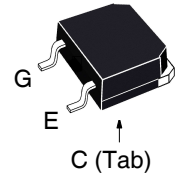

G = Gate C = Collector
 E = Emitter Tab = Collector

| Symbol | Test Conditions | Maximum Ratings | |
|-------------------------------|---|---|------------|
| V_{CES} | $T_J = 25^\circ C$ to $175^\circ C$ | 1200 | V |
| V_{CGR} | $T_J = 25^\circ C$ to $175^\circ C$, $R_{GE} = 1M\Omega$ | 1200 | V |
| V_{GES} | Continuous | ± 20 | V |
| V_{GEM} | Transient | ± 30 | V |
| I_{C25} | $T_C = 25^\circ C$ | 175 | A |
| I_{C110} | $T_C = 110^\circ C$ | 55 | A |
| I_{CM} | $T_C = 25^\circ C$, 1ms | 350 | A |
| SSOA (RBSOA) | $V_{GE} = 15V$, $T_{VJ} = 125^\circ C$, $R_G = 5\Omega$ Clamped Inductive Load | $I_{CM} = 110$ $V_{CE} \leq 0.8 \cdot V_{CES}$ | A |
| P_C | $T_C = 25^\circ C$ | 650 | W |
| T_J | | -55 ... +175 | $^\circ C$ |
| T_{JM} | | 175 | $^\circ C$ |
| T_{stg} | | -55 ... +175 | $^\circ C$ |
| T_{SOLD} | Plastic Body for 10s | 260 | $^\circ C$ |
| Weight | | 4 | g |

Features

- Optimized for Low Conduction Losses
- Positive Thermal Coefficient of $V_{ce(sat)}$
- International Standard Package

Advantages

- High Power Density
- Low Gate Drive Requirement

Applications

- Power Inverters
- UPS
- Motor Drives
- SMPS
- PFC Circuits
- Battery Chargers
- Welding Machines
- Lamp Ballasts
- Inrush Current Protector Circuits

| Symbol | Test Conditions | Characteristic Values | | |
|---------------|--|-----------------------|------------|---------------------|
| | | Min. | Typ. | Max. |
| BV_{CES} | $I_C = 250\mu A$, $V_{GE} = 0V$ | 1200 | | V |
| $V_{GE(th)}$ | $I_C = 250\mu A$, $V_{CE} = V_{GE}$ | 4.0 | | 6.5 V |
| I_{CES} | $V_{CE} = V_{CES}$, $V_{GE} = 0V$ $T_J = 150^\circ C$ | | | 5 μA 2.5 mA |
| I_{GES} | $V_{CE} = 0V$, $V_{GE} = \pm 20V$ | | | ± 100 nA |
| $V_{CE(sat)}$ | $I_C = 55A$, $V_{GE} = 15V$, Note 1 $T_J = 150^\circ C$ | | 1.5 1.8 | V V |

| Symbol Test Conditions ($T_J = 25^\circ\text{C}$ Unless Otherwise Specified) | | Characteristic Values | | |
|--|---|-----------------------|------|-------------------------|
| | | Min. | Typ. | Max. |
| g_{fs} | $I_C = 55\text{A}, V_{CE} = 10\text{V}$, Note 1 | 22 | 36 | S |
| C_{ies} | $V_{CE} = 25\text{V}, V_{GE} = 0\text{V}, f = 1\text{MHz}$ | | 2150 | pF |
| C_{oes} | | | 125 | pF |
| C_{res} | | | 80 | pF |
| $Q_{g(on)}$ | $I_C = 55\text{A}, V_{GE} = 15\text{V}, V_{CE} = 0.5 \cdot V_{CES}$ | | 110 | nC |
| Q_{ge} | | | 17 | nC |
| Q_{gc} | | | 56 | nC |
| $t_{d(on)}$ | Inductive load, $T_J = 25^\circ\text{C}$ $I_C = 40\text{A}, V_{GE} = 15\text{V}$ $V_{CE} = 0.5 \cdot V_{CES}, R_G = 5\Omega$ Note 2 | | 23 | ns |
| t_{ri} | | | 35 | ns |
| E_{on} | | | 2.3 | mJ |
| $t_{d(off)}$ | | | 300 | ns |
| t_{fi} | | | 270 | ns |
| E_{off} | | | 5.3 | mJ |
| $t_{d(on)}$ | Inductive load, $T_J = 150^\circ\text{C}$ $I_C = 40\text{A}, V_{GE} = 15\text{V}$ $V_{CE} = 0.5 \cdot V_{CES}, R_G = 5\Omega$ Note 2 | | 21 | ns |
| t_{ri} | | | 33 | ns |
| E_{on} | | | 3.8 | mJ |
| $t_{d(off)}$ | | | 380 | ns |
| t_{fi} | | | 530 | ns |
| E_{off} | | | 8.8 | mJ |
| R_{thJC} | | | | 0.23 $^\circ\text{C/W}$ |

Notes:

1. Pulse test, $t \leq 300\mu\text{s}$, duty cycle, $d \leq 2\%$.
2. Switching times & energy losses may increase for higher $V_{CE}(\text{clamp})$, T_J or R_G .

Littelfuse Reserves the Right to Change Limits, Test Conditions, and Dimensions.

| | | | | | | | | | | |
|---|-----------|-----------|-----------|-----------|--------------|--------------|--------------|--------------|--------------|-------------|
| IXYS MOSFETs and IGBTs are covered | 4,835,592 | 4,931,844 | 5,049,961 | 5,237,481 | 6,162,665 | 6,404,065 B1 | 6,683,344 | 6,727,585 | 7,005,734 B2 | 7,157,338B2 |
| by one or more of the following U.S. patents: | 4,860,072 | 5,017,508 | 5,063,307 | 5,381,025 | 6,259,123 B1 | 6,534,343 | 6,710,405 B2 | 6,759,692 | 7,063,975 B2 | |
| | 4,881,106 | 5,034,796 | 5,187,117 | 5,486,715 | 6,306,728 B1 | 6,583,505 | 6,710,463 | 6,771,478 B2 | 7,071,537 | |

Fig. 1. Output Characteristics @ $T_J = 25^\circ\text{C}$

Fig. 2. Extended Output Characteristics @ $T_J = 25^\circ\text{C}$

Fig. 3. Output Characteristics @ $T_J = 150^\circ\text{C}$

Fig. 4. Dependence of $V_{CE(sat)}$ on Junction Temperature

Fig. 5. Collector-to-Emitter Voltage vs. Gate-to-Emitter Voltage

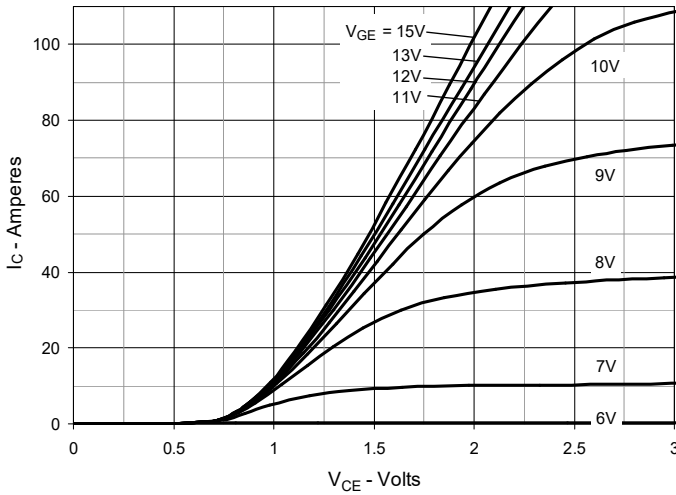
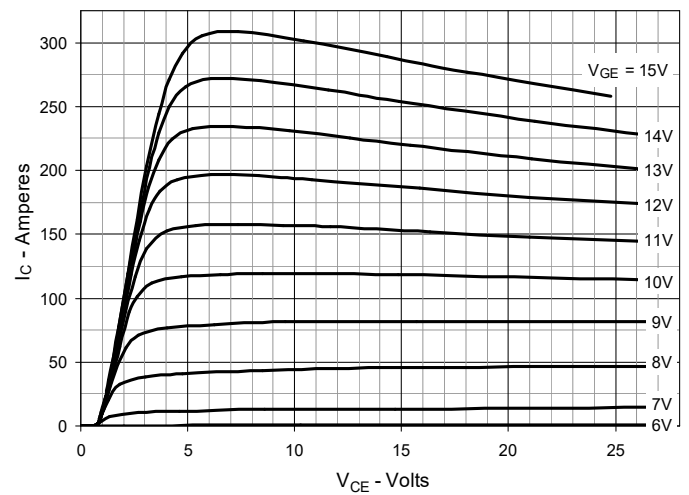
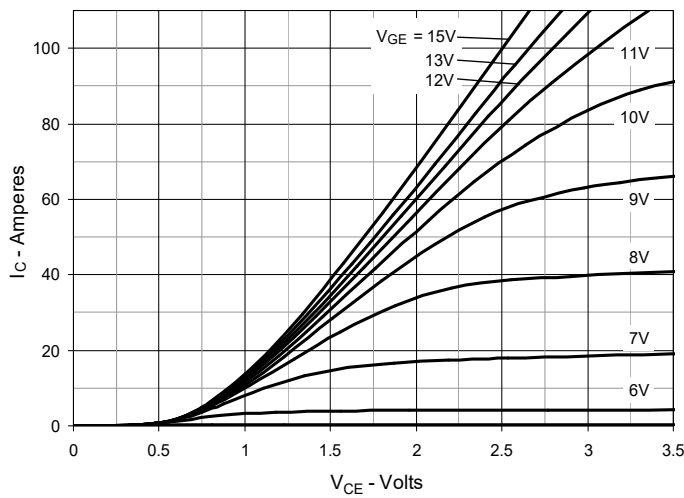
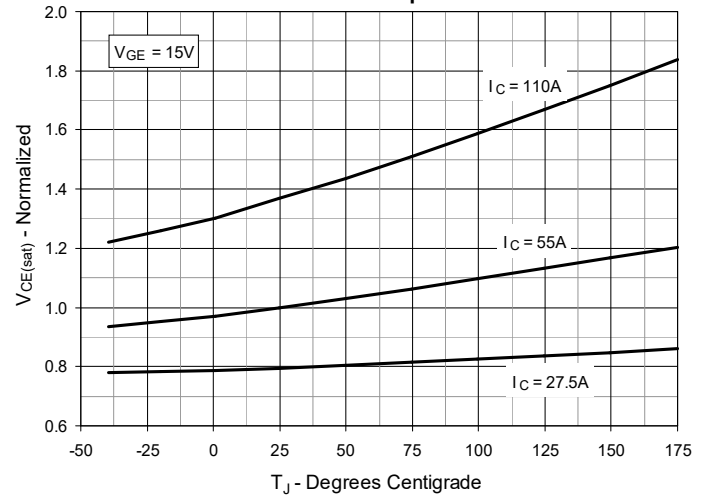
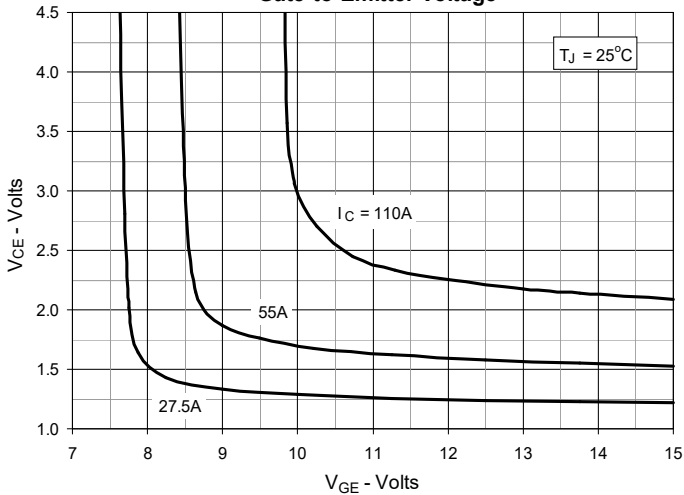
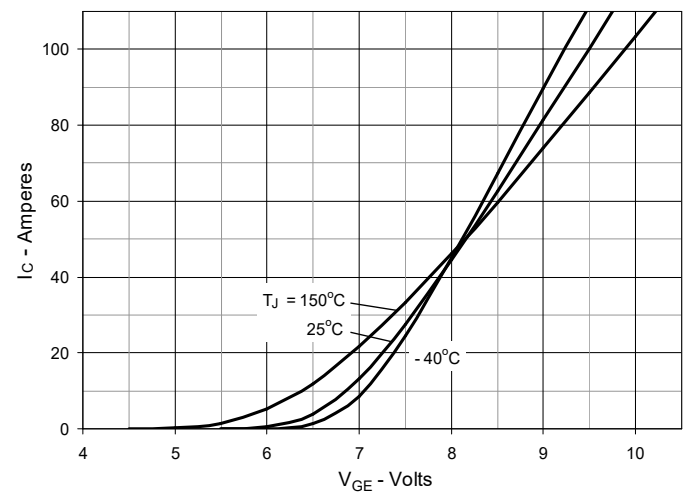
Fig. 6. Input Admittance

Fig. 7. Transconductance

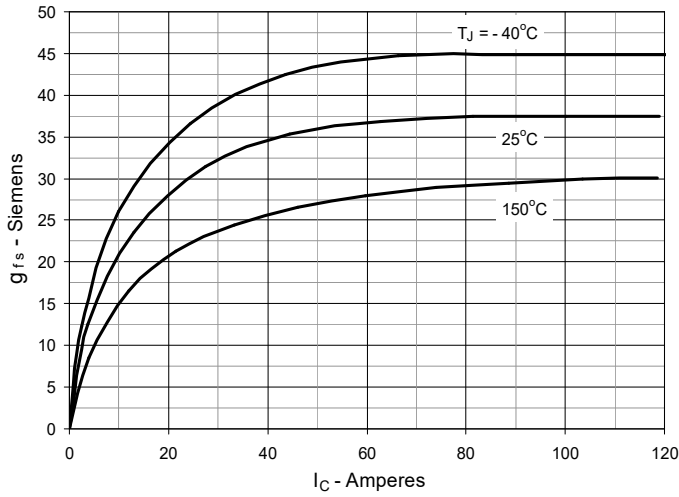

Fig. 8. Gate Charge

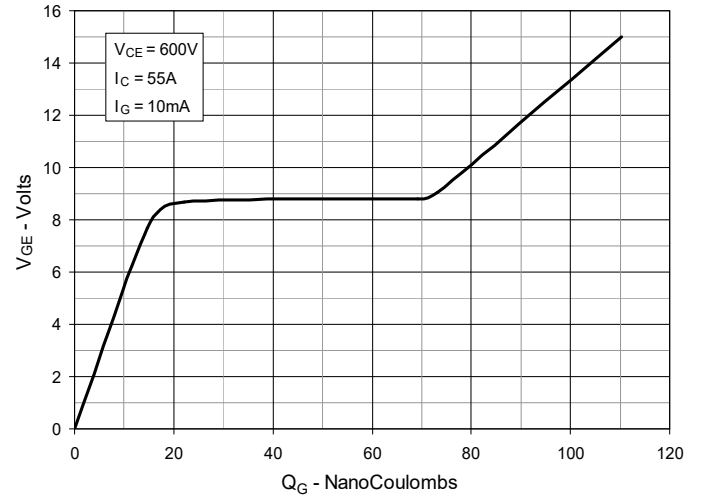

Fig. 9. Capacitance

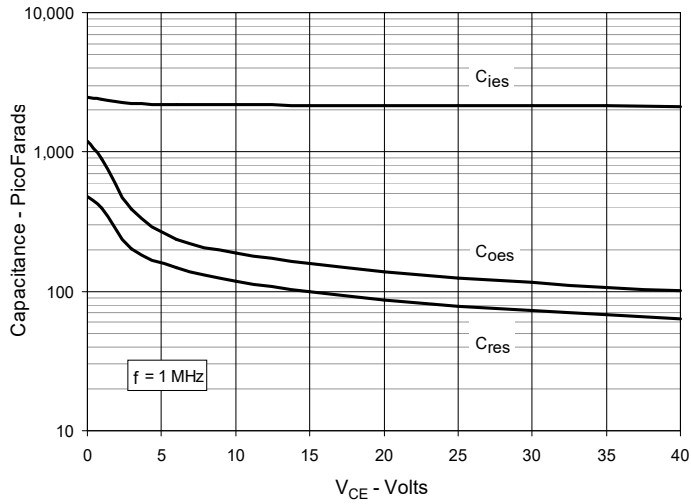

Fig. 10. Reverse-Bias Safe Operating Area

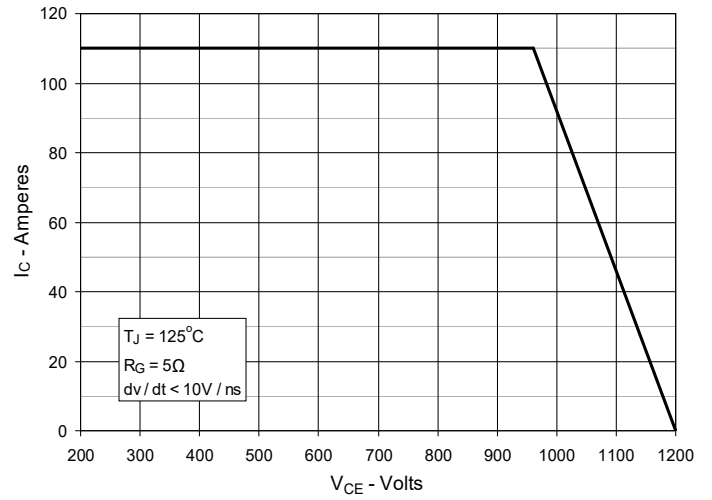

Fig. 11. Maximum Transient Thermal Impedance

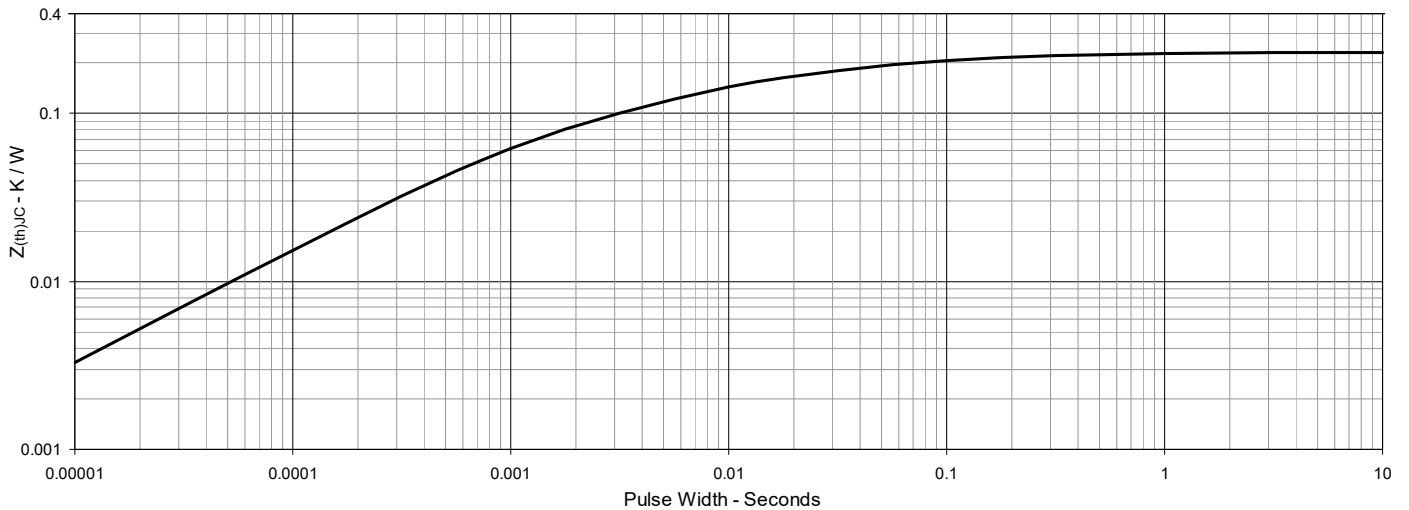

Fig. 12. Inductive Switching Energy Loss vs. Collector Current

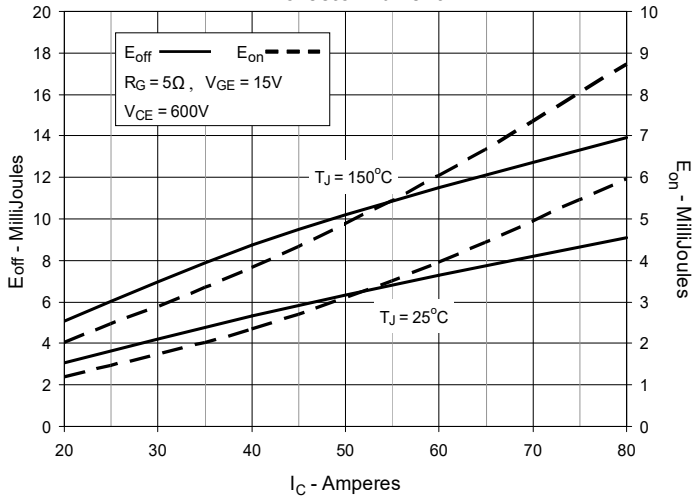

Fig. 13. Inductive Switching Energy Loss vs. Collector-Emitter Voltage

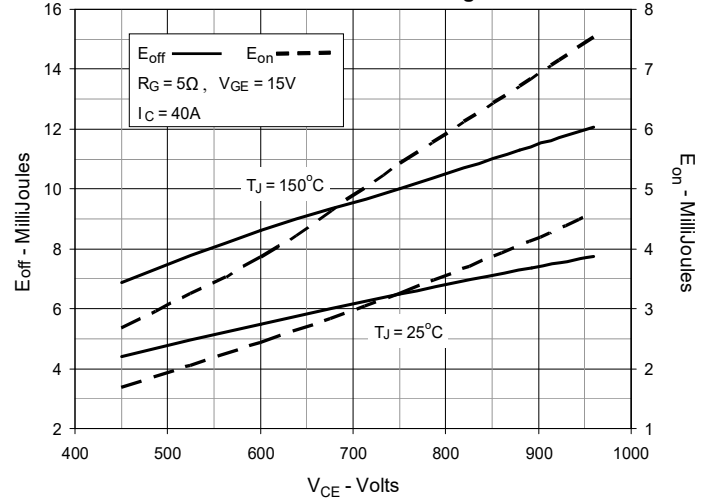

Fig. 14. Inductive Switching Energy Loss vs. Gate Resistance

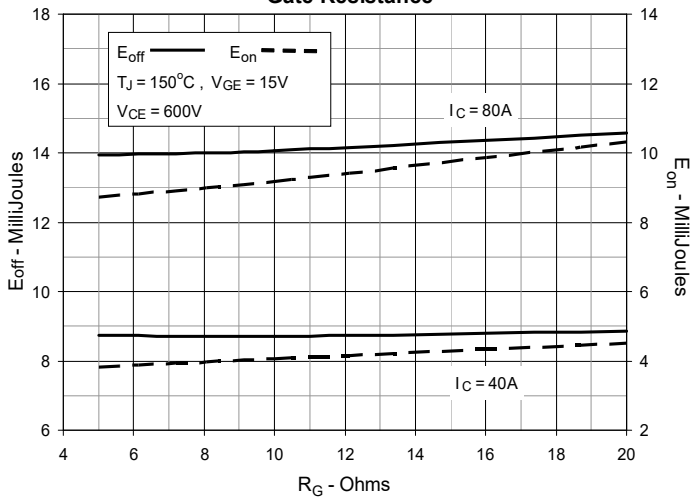

Fig. 15. Inductive Switching Energy Loss vs. Junction Temperature

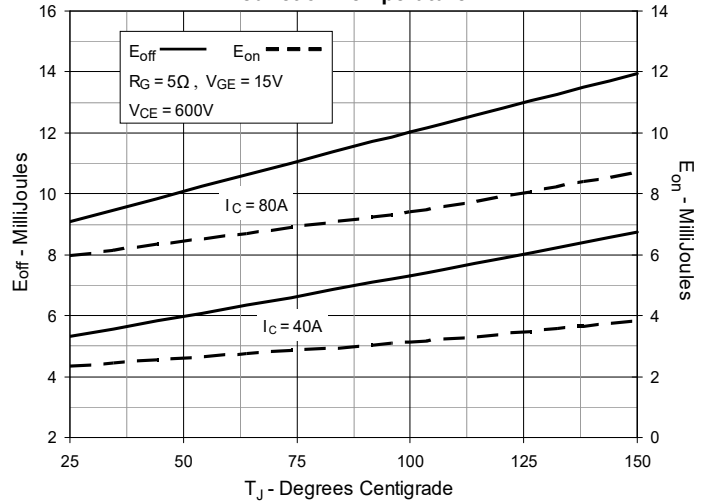

Fig. 16. Inductive Turn-off Switching Times vs. Gate Resistance

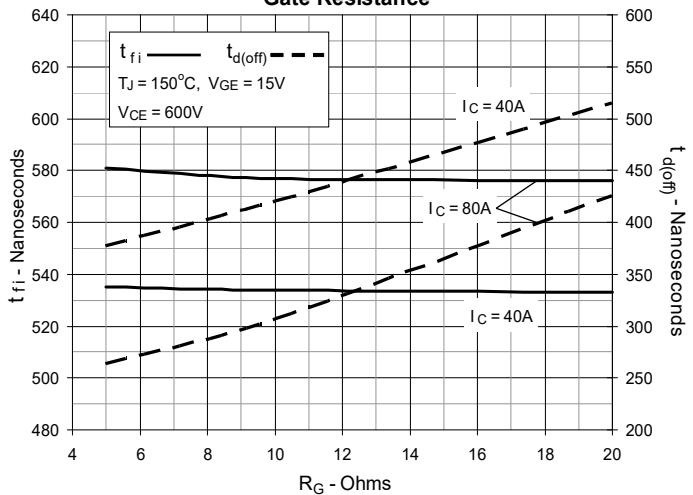

Fig. 17. Inductive Turn-off Switching Times vs. Collector Current

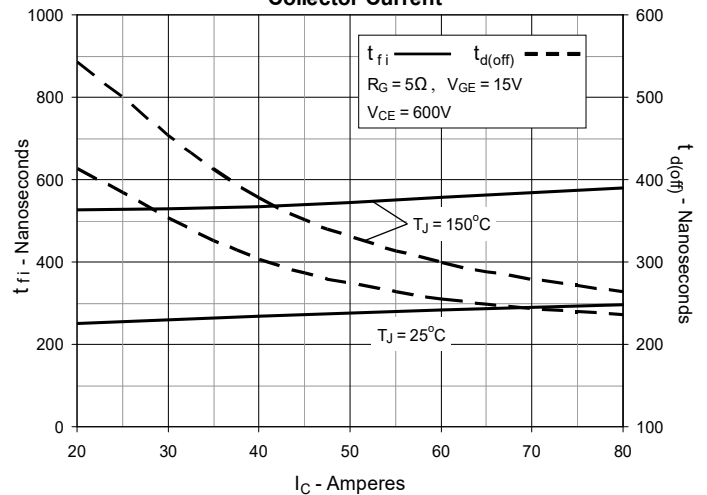

Fig. 18. Inductive Turn-off Switching Times vs. Junction Temperature

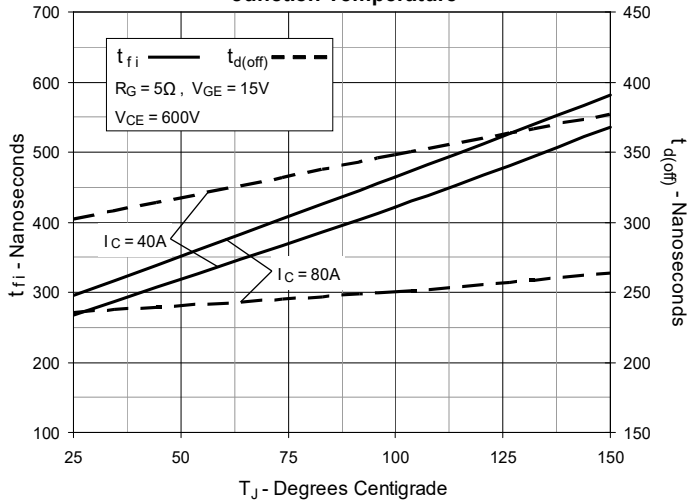

Fig. 19. Inductive Turn-on Switching Times vs. Gate Resistance

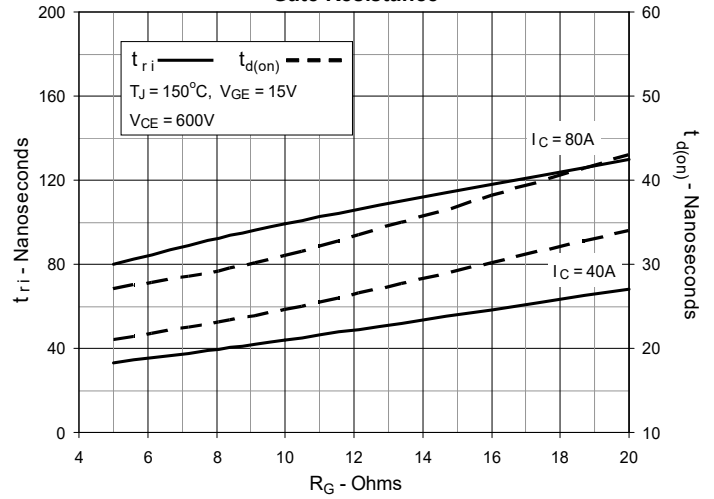

Fig. 20. Inductive Turn-on Switching Times vs. Collector Current

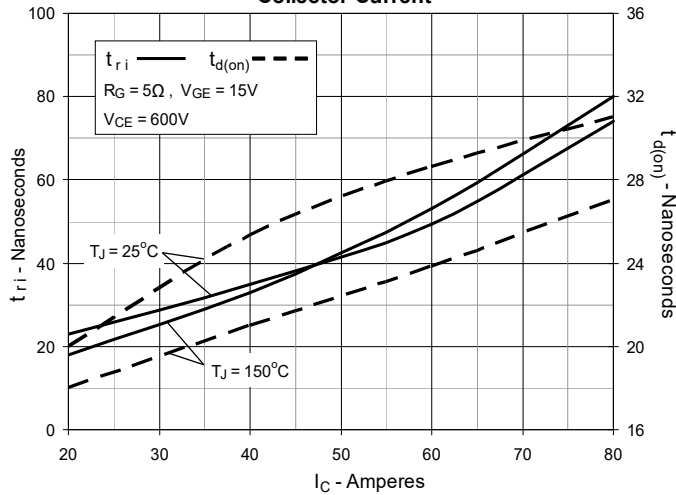
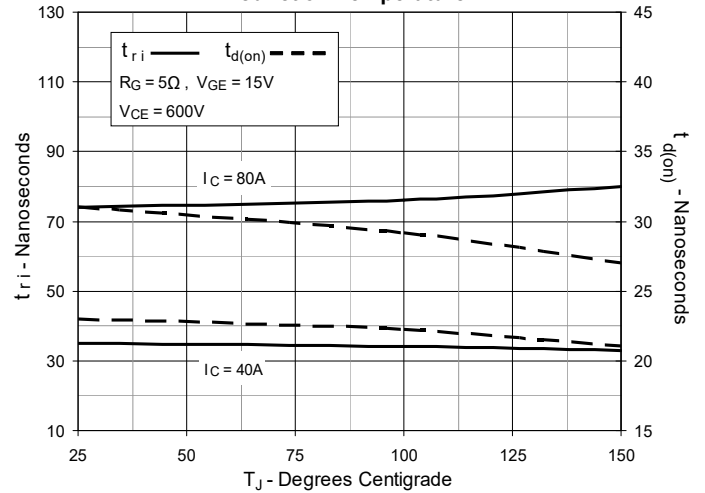
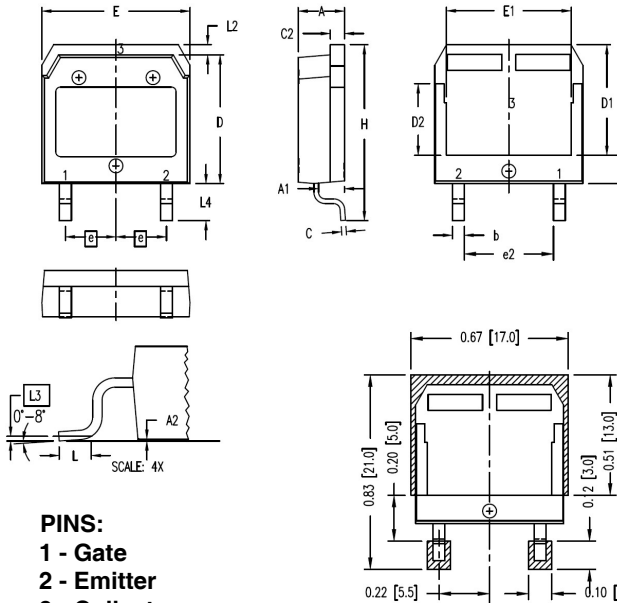

Fig. 21. Inductive Turn-on Switching Times vs. Junction Temperature



TO-268HV Outline

PINS:
1 - Gate
2 - Emitter
3 - Collector

| SYM | INCHES | | MILLIMETER | |
|------|----------|------|------------|-------|
| | MIN | MAX | MIN | MAX |
| A | .193 | .201 | 4.90 | 5.10 |
| A1 | .106 | .114 | 2.70 | 2.90 |
| A2 | .001 | .010 | 0.02 | 0.25 |
| b | .045 | .057 | 1.15 | 1.45 |
| C | .016 | .026 | 0.40 | 0.65 |
| C2 | .057 | .063 | 1.45 | 1.60 |
| D | .543 | .551 | 13.80 | 14.00 |
| D1 | .465 | .476 | 11.80 | 12.10 |
| D2 | .295 | .307 | 7.50 | 7.80 |
| D3 | .114 | .126 | 2.90 | 3.20 |
| E | .624 | .632 | 15.85 | 16.05 |
| E1 | .524 | .535 | 13.30 | 13.60 |
| e | .215 BSC | | 5.45 BSC | |
| (e2) | .374 | .386 | 9.50 | 9.80 |
| H | .736 | .752 | 18.70 | 19.10 |
| L | .067 | .079 | 1.70 | 2.00 |
| L2 | .039 | .045 | 1.00 | 1.15 |
| L3 | .010 BSC | | 0.25 BSC | |
| L4 | .150 | .161 | 3.80 | 4.10 |



Disclaimer Notice - Information furnished is believed to be accurate and reliable. However, users should independently evaluate the suitability of and test each product selected for their own applications. Littelfuse products are not designed for, and may not be used in, all applications. Read complete Disclaimer Notice at www.littelfuse.com/disclaimer-electronics.

Littelfuse Reserves the Right to Change Limits, Test Conditions, and Dimensions.
