

# 1200V XPT™ IGBT GenX3™ w/ Diode

## IXYR50N120C3D1

(Electrically Isolated Tab)

High-Speed IGBT  
for 20-50 kHz Switching

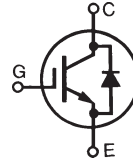

$$\begin{aligned} V_{CES} &= 1200V \\ I_{C90} &= 32A \\ V_{CE(sat)} &\leq 3.5V \\ t_{fi(typ)} &= 43ns \end{aligned}$$

Symbol	Test Conditions	Maximum Ratings	
$V_{CES}$	$T_J = 25^\circ\text{C}$ to $150^\circ\text{C}$	1200	V
$V_{CGR}$	$T_J = 25^\circ\text{C}$ to $150^\circ\text{C}$ , $R_{GE} = 1M\Omega$	1200	V
$V_{GES}$	Continuous	$\pm 20$	V
$V_{GEM}$	Transient	$\pm 30$	V
$I_{C25}$	$T_C = 25^\circ\text{C}$ (Chip Capability)	56	A
$I_{C90}$	$T_C = 90^\circ\text{C}$	32	A
$I_{F110}$	$T_C = 110^\circ\text{C}$	18	A
$I_{CM}$	$T_C = 25^\circ\text{C}$ , 1ms	210	A
<b>SSOA</b>	$V_{GE} = 15V$ , $T_{VJ} = 150^\circ\text{C}$ , $R_G = 5\Omega$	$I_{CM} = 100$	A
<b>(RBSOA)</b>	Clamped Inductive Load	@ $V_{CE} \leq V_{CES}$	
$P_C$	$T_C = 25^\circ\text{C}$	290	W
$T_J$		-55 ... +150	$^\circ\text{C}$
$T_{JM}$		150	$^\circ\text{C}$
$T_{stg}$		-55 ... +150	$^\circ\text{C}$
$T_L$	Maximum Lead Temperature for Soldering	300	$^\circ\text{C}$
$T_{SOLD}$	1.6 mm (0.062in.) from Case for 10s	260	$^\circ\text{C}$
$V_{ISOL}$	50/60 Hz, 1 Minute	2500	V~
$F_C$	Mounting Force	20..120/4.5..27	N/lb.
<b>Weight</b>		5	g

### ISOPLUS247™

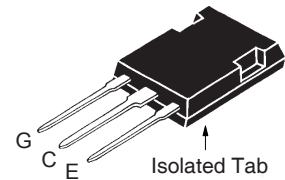

G = Gate      C = Collector  
E = Emitter

### Features

- Silicon Chip on Direct-Copper Bond (DCB) Substrate
- Isolated Mounting Surface
- 2500V~ Electrical Isolation
- Optimized for Low Switching Losses
- Square RBSOA
- Positive Thermal Coefficient of  $V_{ce(sat)}$
- Anti-Parallel Ultra Fast Diode
- High Current Handling Capability
- International Standard Package

### Advantages

- High Power Density
- Low Gate Drive Requirement

### Applications

- High Frequency Power Inverters
- UPS
- Motor Drives
- SMPS
- PFC Circuits
- Battery Chargers
- Welding Machines
- Lamp Ballasts

Symbol	Test Conditions ( $T_J = 25^\circ\text{C}$ , Unless Otherwise Specified)	Characteristic Values		
		Min.	Typ.	Max.
$BV_{CES}$	$I_C = 250\mu\text{A}$ , $V_{GE} = 0V$	1200		V
$V_{GE(th)}$	$I_C = 250\mu\text{A}$ , $V_{CE} = V_{GE}$	3.0		5.0 V
$I_{CES}$	$V_{CE} = V_{CES}$ , $V_{GE} = 0V$ $T_J = 125^\circ\text{C}$			50 $\mu\text{A}$ 500 $\mu\text{A}$
$I_{GES}$	$V_{CE} = 0V$ , $V_{GE} = \pm 20V$			$\pm 100$ nA
$V_{CE(sat)}$	$I_C = 50A$ , $V_{GE} = 15V$ , Note 1 $T_J = 150^\circ\text{C}$	4.2		3.5 V V

Symbol Test Conditions ( $T_J = 25^\circ\text{C}$ Unless Otherwise Specified)		Characteristic Values		
		Min.	Typ.	Max.
$g_{fs}$	$I_C = 50\text{A}, V_{CE} = 10\text{V}$ , Note 1	20	32	S
$C_{ies}$	$V_{CE} = 25\text{V}, V_{GE} = 0\text{V}, f = 1\text{MHz}$		3100	pF
$C_{oes}$			230	pF
$C_{res}$			66	pF
$Q_{g(on)}$	$I_C = 50\text{A}, V_{GE} = 15\text{V}, V_{CE} = 0.5 \cdot V_{CES}$		142	nC
$Q_{ge}$			23	nC
$Q_{gc}$			60	nC
$t_{d(on)}$	<b>Inductive load, <math>T_J = 25^\circ\text{C}</math></b> $I_C = 50\text{A}, V_{GE} = 15\text{V}$ $V_{CE} = 0.5 \cdot V_{CES}, R_G = 5\Omega$ Note 2		28	ns
$t_{ri}$			62	ns
$E_{on}$			3.0	mJ
$t_{d(off)}$			133	ns
$t_{fi}$			43	ns
$E_{off}$			1.0	1.7 mJ
$t_{d(on)}$	<b>Inductive load, <math>T_J = 150^\circ\text{C}</math></b> $I_C = 50\text{A}, V_{GE} = 15\text{V}$ $V_{CE} = 0.5 \cdot V_{CES}, R_G = 5\Omega$ Note 2		28	ns
$t_{ri}$			68	ns
$E_{on}$			6.0	mJ
$t_{d(off)}$			160	ns
$t_{fi}$			60	ns
$E_{off}$			1.4	mJ
$R_{thJC}$				0.43 $^\circ\text{C/W}$
$R_{thCS}$		0.15		$^\circ\text{C/W}$

### ISOPLUS247 (IXYR) Outline

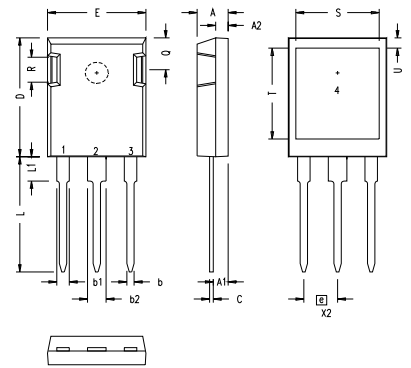

SYM	INCHES		MILLIMETERS	
	MIN	MAX	MIN	MAX
A	.190	.205	4.83	5.21
A1	.090	.100	2.29	2.54
A2	.075	.085	1.91	2.16
b	.045	.055	1.14	1.40
b1	.075	.084	1.91	2.13
b2	.115	.123	2.92	3.12
C	.024	.031	0.61	0.80
D	.819	.840	20.80	21.34
E	.620	.635	15.75	16.13
e	.215 BSC		5.45 BSC	
L	.780	.800	19.81	20.32
L1	.150	.170	3.81	4.32
Q	.220	.244	5.59	6.20
R	.170	.190	4.32	4.83
S	.520	.540	13.21	13.72
T	.620	.640	15.75	16.26
U	.065	.080	1.65	2.03

- 1 - Gate
- 2,4 - Collector
- 3 - Emitter

### Reverse Diode (FRED)

Symbol Test Conditions ( $T_J = 25^\circ\text{C}$ , Unless Otherwise Specified)		Characteristic Value		
		Min.	Typ.	Max.
$V_F$	$I_F = 30\text{A}, V_{GE} = 0\text{V}$ , Note 1			3.00 V
		$T_J = 150^\circ\text{C}$	1.75	V
$I_{RM}$	$I_F = 30\text{A}, V_{GE} = 0\text{V}, -di_F/dt = 100\text{A}/\mu\text{s}, V_R = 600\text{V}$	$T_J = 100^\circ\text{C}$		9 A
$t_{rr}$		$T_J = 100^\circ\text{C}$	195	
$R_{thJC}$				1.10 $^\circ\text{C/W}$

### Notes:

- Pulse test,  $t \leq 300\mu\text{s}$ , duty cycle,  $d \leq 2\%$ .
- Switching times & energy losses may increase for higher  $V_{CE}$  (clamp),  $T_J$  or  $R_G$ .

IXYS Reserves the Right to Change Limits, Test Conditions, and Dimensions.

IXYS MOSFETs and IGBTs are covered by one or more of the following U.S. patents:	4,835,592	4,931,844	5,049,961	5,237,481	6,162,665	6,404,065 B1	6,683,344	6,727,585	7,005,734 B2	7,157,338B2
	4,860,072	5,017,508	5,063,307	5,381,025	6,259,123 B1	6,534,343	6,710,405 B2	6,759,692	7,063,975 B2	
	4,881,106	5,034,796	5,187,117	5,486,715	6,306,728 B1	6,583,505	6,710,463	6,771,478 B2	7,071,537	

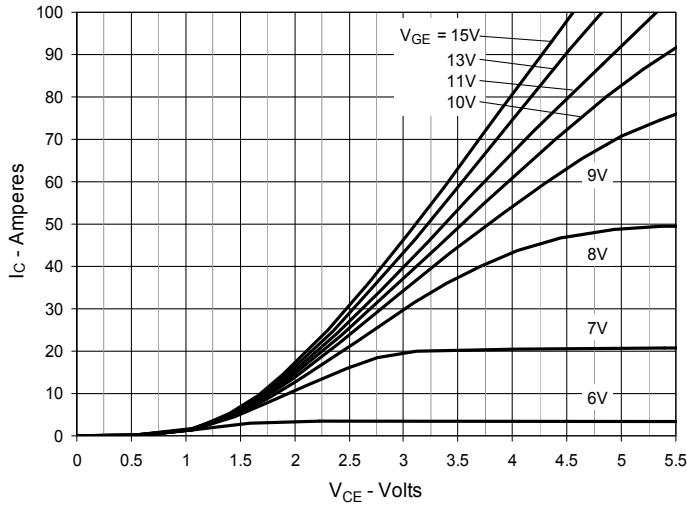
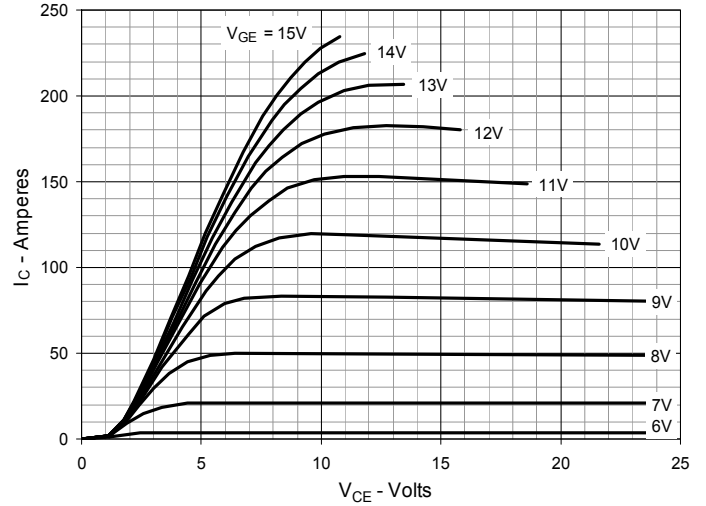
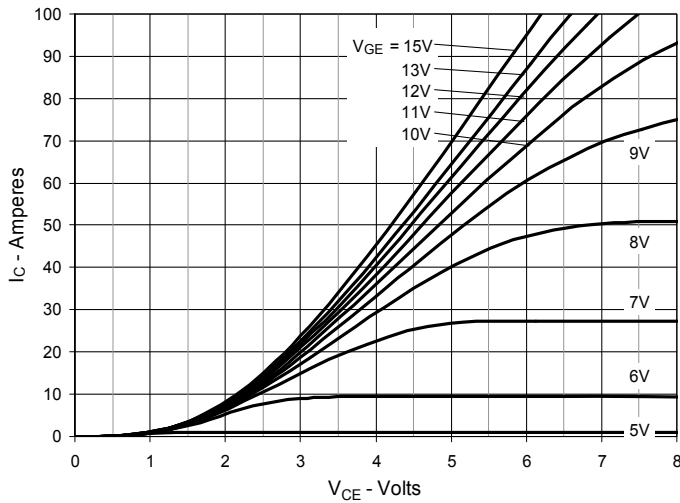
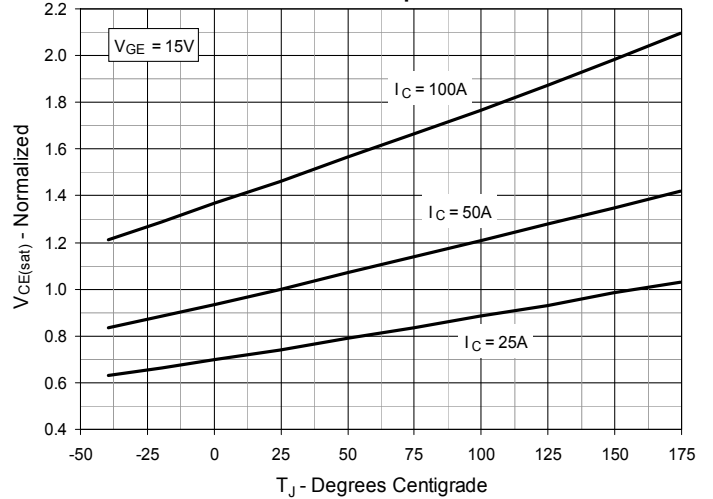
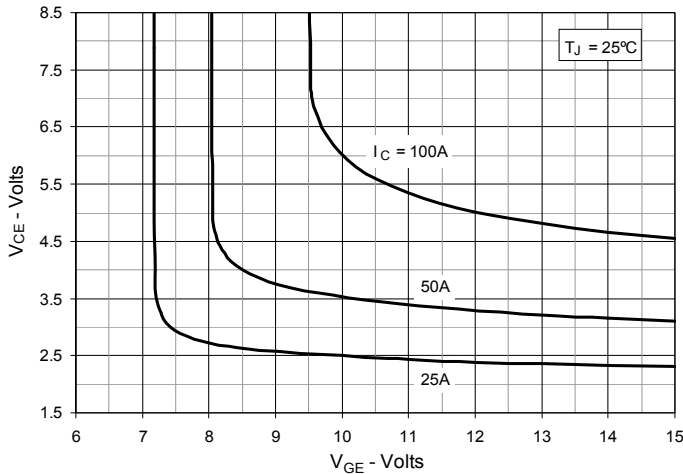
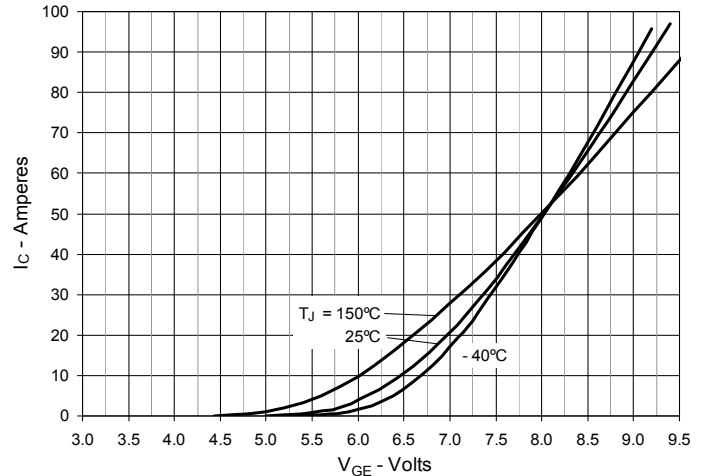
**Fig. 1. Output Characteristics @  $T_J = 25^\circ\text{C}$** 

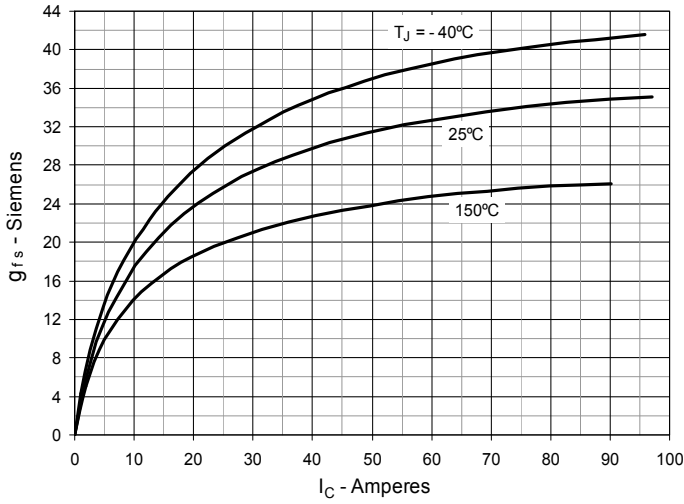
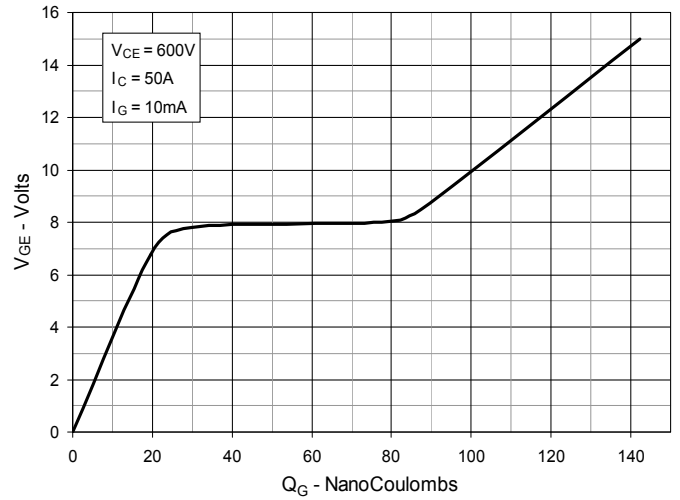
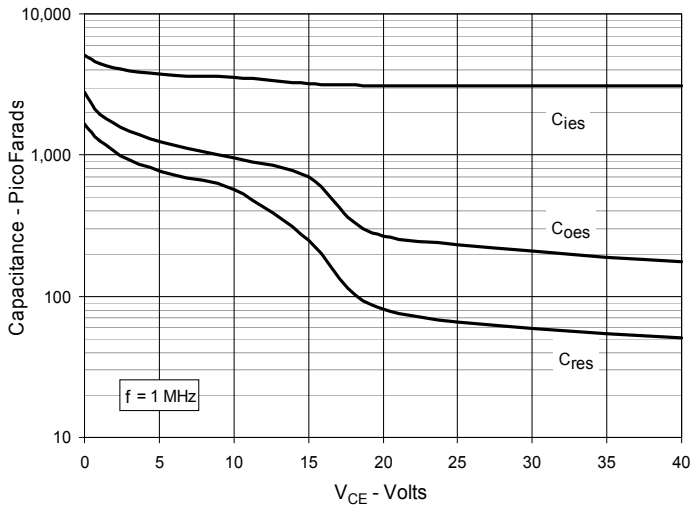
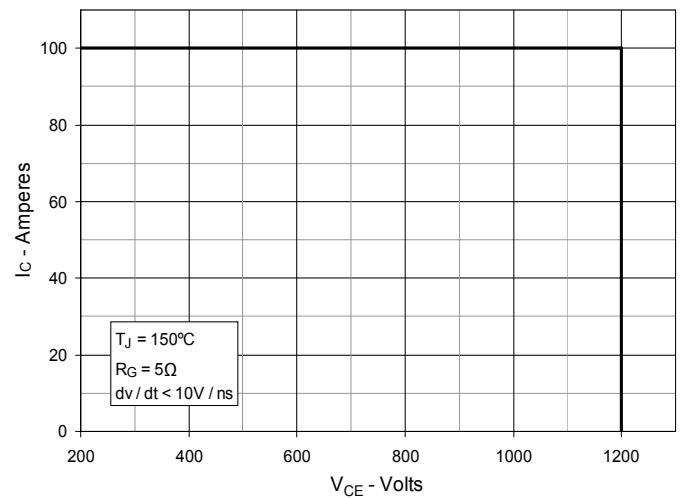
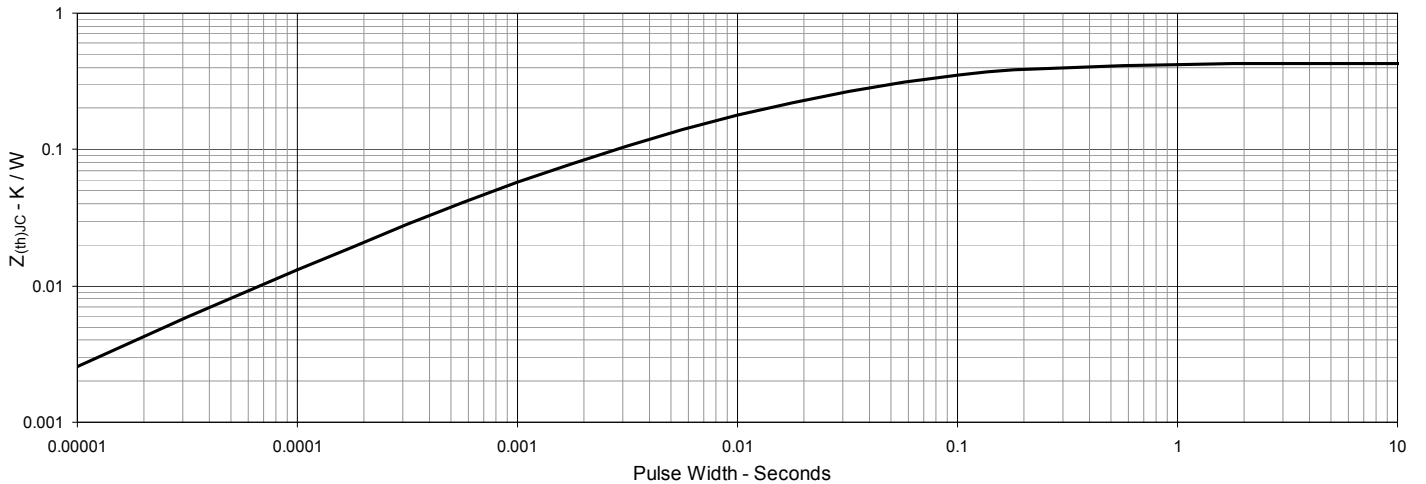
**Fig. 2. Extended Output Characteristics @  $T_J = 25^\circ\text{C}$** 

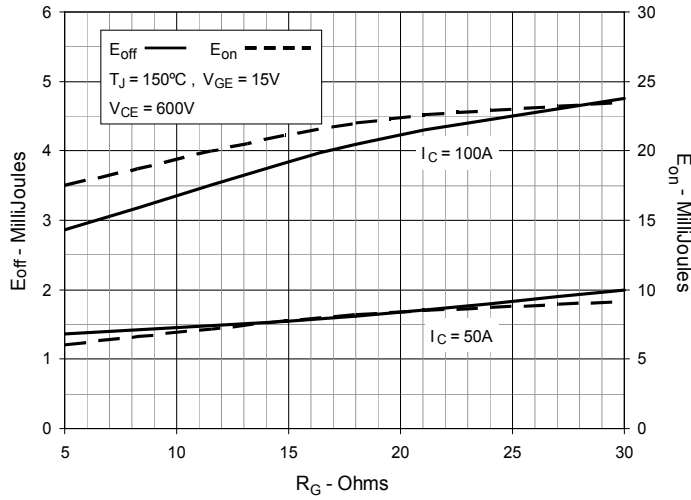
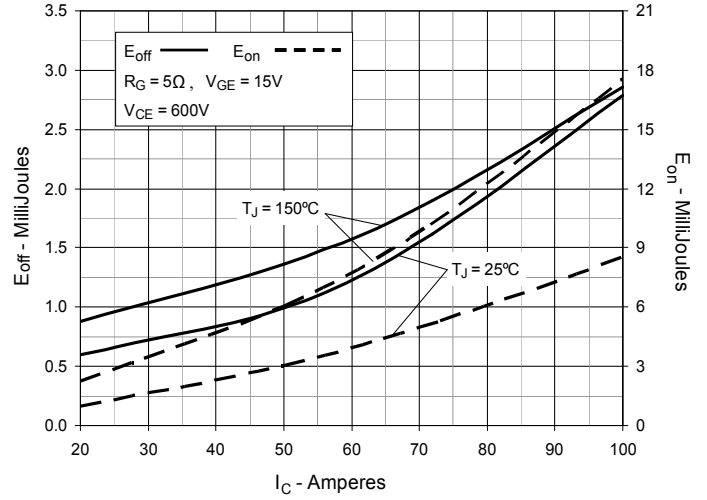
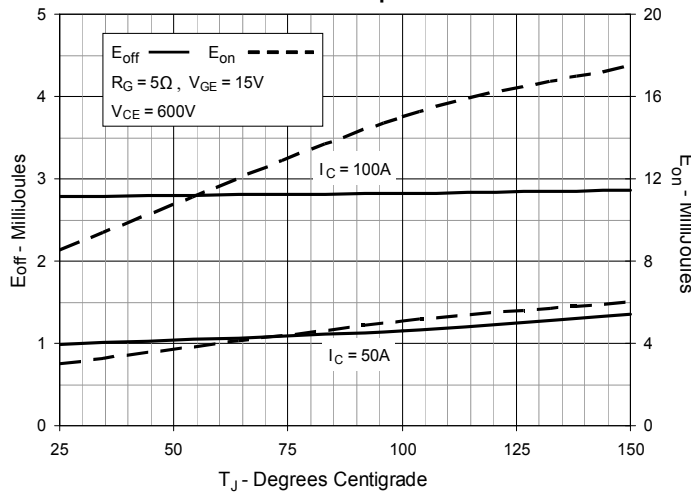
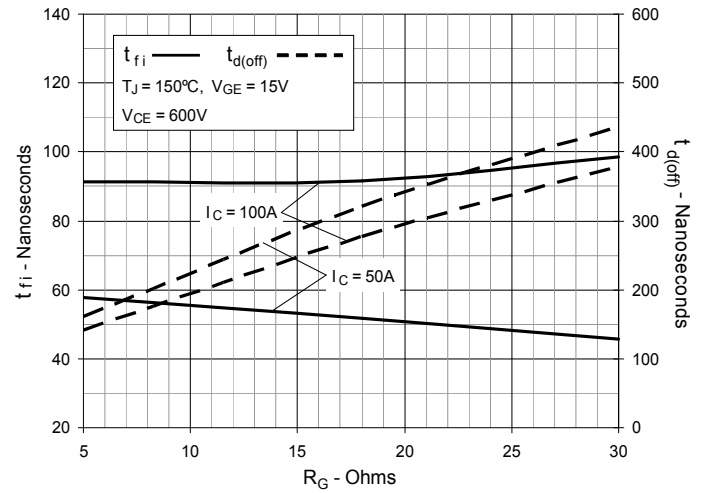
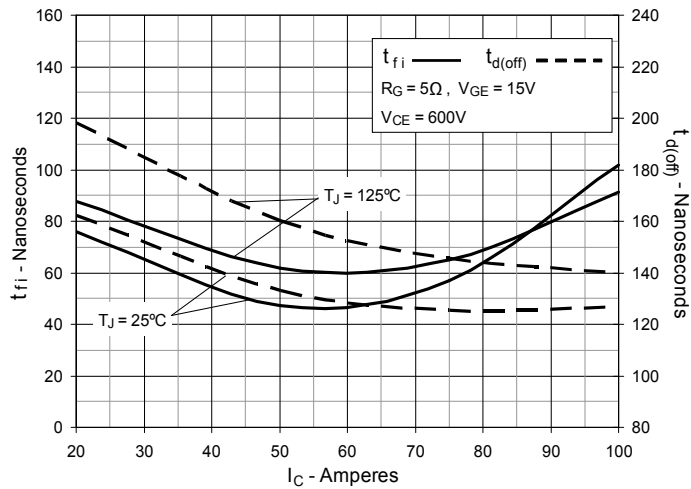
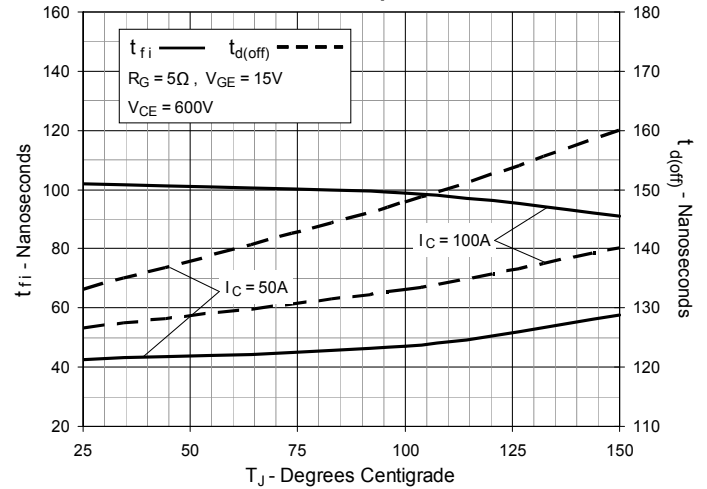
**Fig. 3. Output Characteristics @  $T_J = 150^\circ\text{C}$** 

**Fig. 4. Dependence of  $V_{CE(sat)}$  on Junction Temperature**

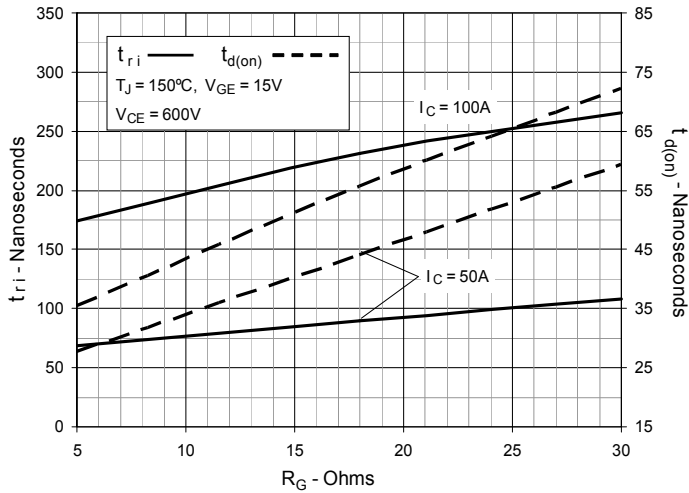
**Fig. 5. Collector-to-Emitter Voltage vs. Gate-to-Emitter Voltage**

**Fig. 6. Input Admittance**

**Fig. 7. Transconductance**

**Fig. 8. Gate Charge**

**Fig. 9. Capacitance**

**Fig. 10. Reverse-Bias Safe Operating Area**

**Fig. 11. Maximum Transient Thermal Impedance**

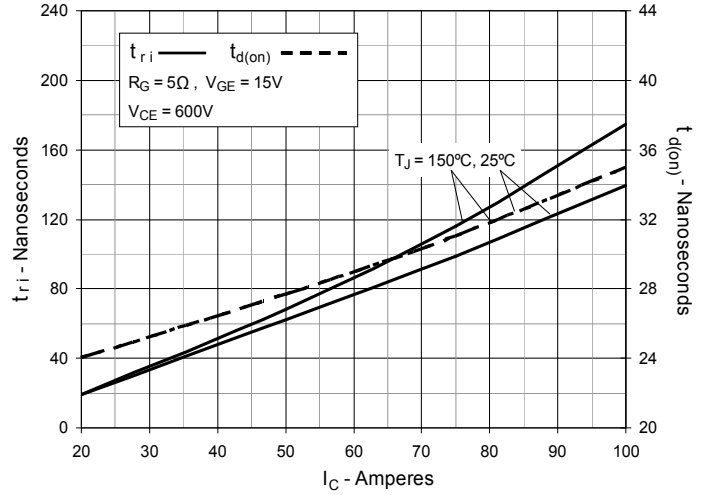
**Fig. 12. Inductive Switching Energy Loss vs. Gate Resistance**

**Fig. 13. Inductive Switching Energy Loss vs. Collector Current**

**Fig. 14. Inductive Switching Energy Loss vs. Junction Temperature**

**Fig. 15. Inductive Turn-off Switching Times vs. Gate Resistance**

**Fig. 16. Inductive Turn-off Switching Times vs. Collector Current**

**Fig. 17. Inductive Turn-off Switching Times vs. Junction Temperature**

**Fig. 18. Inductive Turn-on Switching Times vs. Gate Resistance**



**Fig. 19. Inductive Turn-on Switching Times vs. Collector Current**



**Fig. 20. Inductive Turn-on Switching Times vs. Junction Temperature**

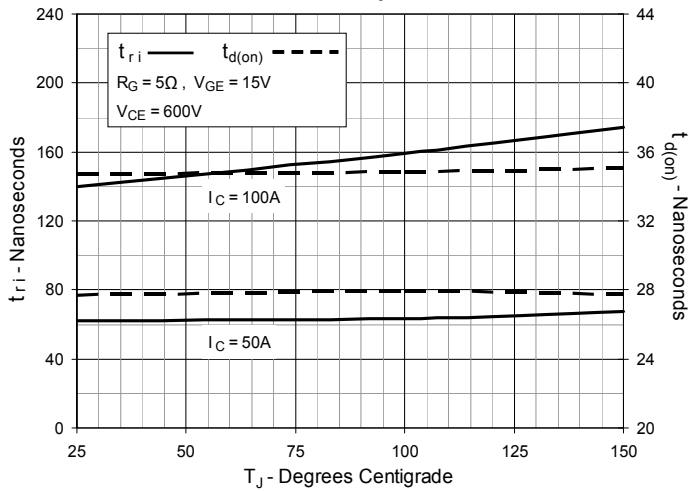

**Fig. 21. Maximum Transient Thermal Impedance (Diode)**

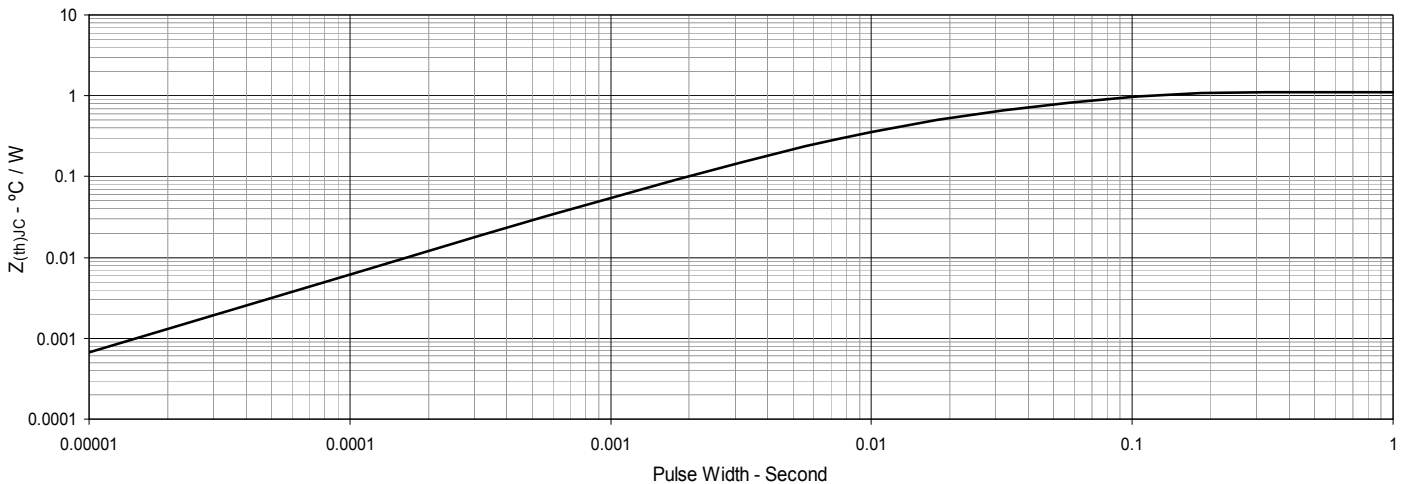

**Fig. 22. Forward Current  $I_F$  vs  $V_F$**

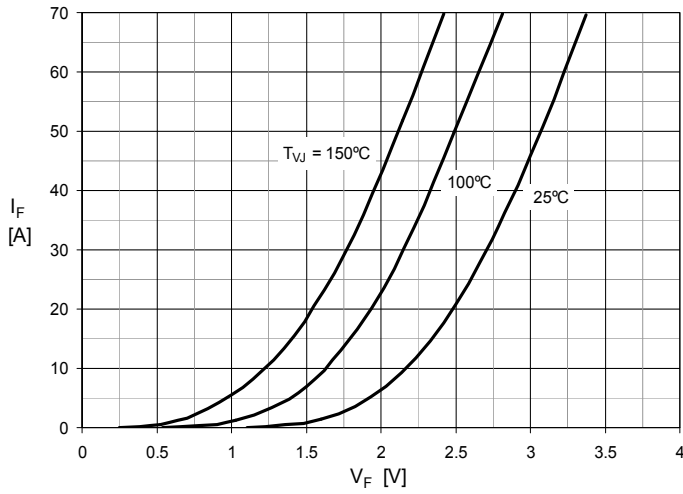

**Fig. 23. Reverse Recovery Charge  $Q_{RM}$  vs.  $-di_F/dt$**

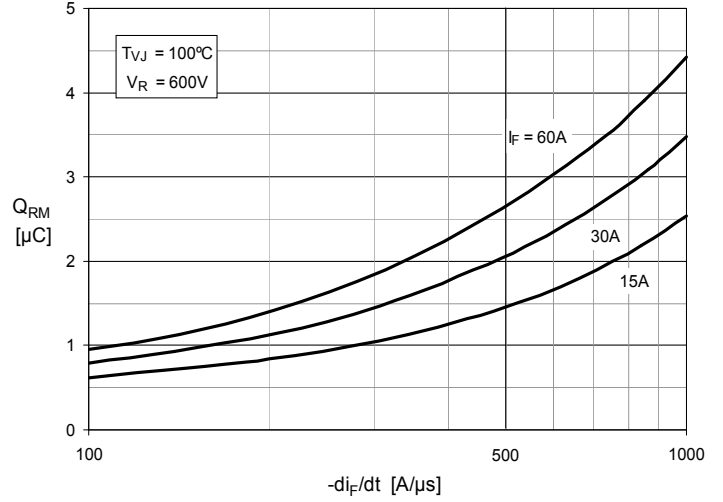

**Fig. 24. Peak Reverse Current  $I_{RM}$  vs.  $-di_F/dt$**

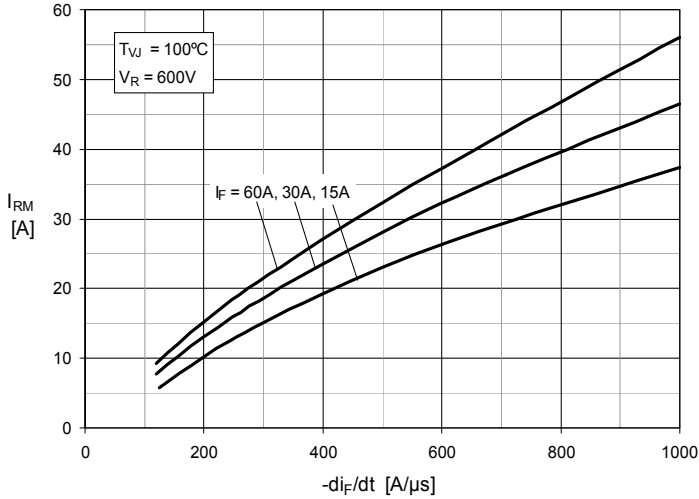

**Fig. 25. Dynamic Parameters  $Q_{RM}$ ,  $I_{RM}$  vs.  $T_{VJ}$**

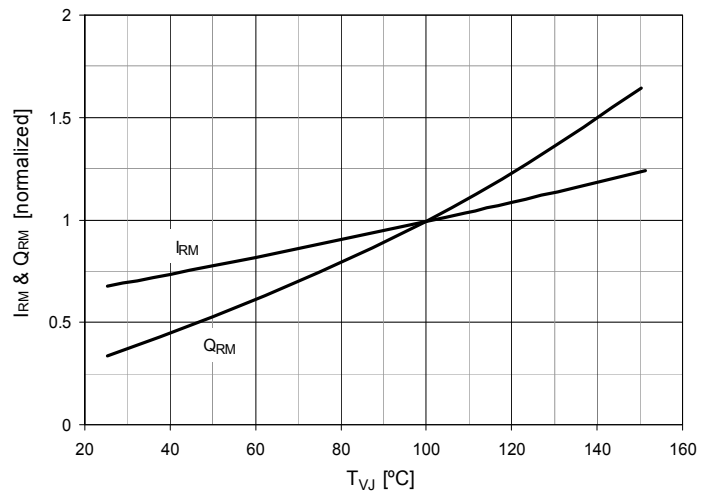

**Fig. 26. Recovery Time  $t_{rr}$  vs.  $-di_F/dt$**

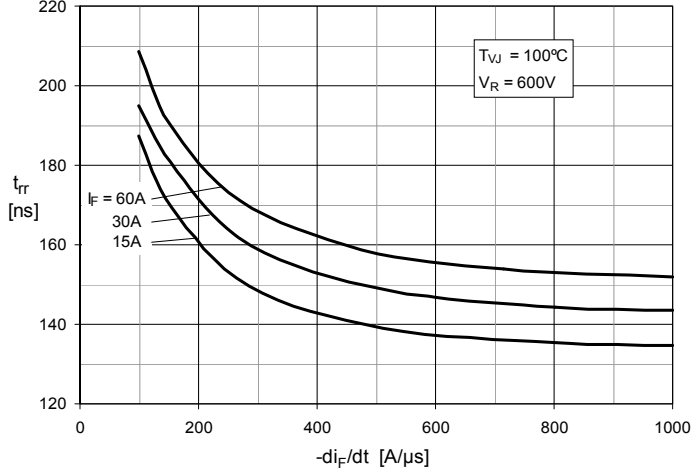

**Fig. 27. Peak Forward Voltage  $V_{FR}$ ,  $t_{rr}$  vs  $-di_F/dt$**

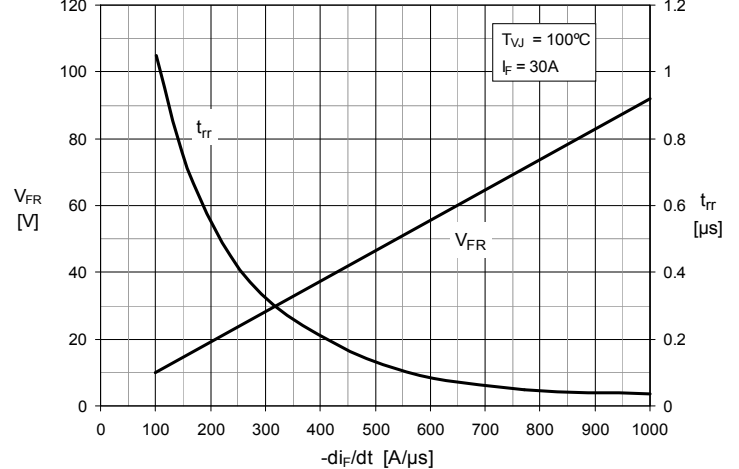



---

Disclaimer Notice - Information furnished is believed to be accurate and reliable. However, users should independently evaluate the suitability of and test each product selected for their own applications. Littelfuse products are not designed for, and may not be used in, all applications. Read complete Disclaimer Notice at [www.littelfuse.com/disclaimer-electronics](http://www.littelfuse.com/disclaimer-electronics).