

1200V XPT™ IGBT GenX3™ w/ Diode

IXYR50N120C3D1

(Electrically Isolated Tab)

High-Speed IGBT
for 20-50 kHz Switching

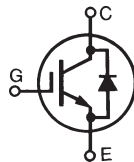

$V_{CES} = 1200V$
 $I_{C90} = 32A$
 $V_{CE(sat)} \leq 3.5V$
 $t_{fi(typ)} = 43ns$

Symbol	Test Conditions	Maximum Ratings	
V_{CES}	$T_J = 25^\circ C$ to $150^\circ C$	1200	V
V_{CGR}	$T_J = 25^\circ C$ to $150^\circ C$, $R_{GE} = 1M\Omega$	1200	V
V_{GES}	Continuous	± 20	V
V_{GEM}	Transient	± 30	V
I_{C25}	$T_C = 25^\circ C$ (Chip Capability)	56	A
I_{C90}	$T_C = 90^\circ C$	32	A
I_{F110}	$T_C = 110^\circ C$	18	A
I_{CM}	$T_C = 25^\circ C$, 1ms	210	A
SSOA (RBSOA)	$V_{GE} = 15V$, $T_{VJ} = 150^\circ C$, $R_G = 5\Omega$ Clamped Inductive Load	$I_{CM} = 100$ @ $V_{CE} \leq V_{CES}$	A
P_C	$T_C = 25^\circ C$	290	W
T_J		-55 ... +150	$^\circ C$
T_{JM}		150	$^\circ C$
T_{stg}		-55 ... +150	$^\circ C$
T_L	Maximum Lead Temperature for Soldering	300	$^\circ C$
T_{SOLD}	1.6 mm (0.062in.) from Case for 10s	260	$^\circ C$
V_{ISOL}	50/60 Hz, 1 Minute	2500	V~
F_C	Mounting Force	20..120/4.5..27	N/lb.
Weight		5	g

ISOPLUS247™

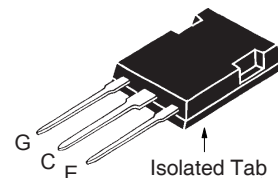

G = Gate C = Collector
E = Emitter

Features

- Silicon Chip on Direct-Copper Bond (DCB) Substrate
- Isolated Mounting Surface
- 2500V~ Electrical Isolation
- Optimized for Low Switching Losses
- Square RBSOA
- Positive Thermal Coefficient of $V_{ce(sat)}$
- Anti-Parallel Ultra Fast Diode
- High Current Handling Capability
- International Standard Package

Advantages

- High Power Density
- Low Gate Drive Requirement

Applications

- High Frequency Power Inverters
- UPS
- Motor Drives
- SMPS
- PFC Circuits
- Battery Chargers
- Welding Machines
- Lamp Ballasts

Symbol	Test Conditions ($T_J = 25^\circ C$, Unless Otherwise Specified)	Characteristic Values		
		Min.	Typ.	Max.
BV_{CES}	$I_C = 250\mu A$, $V_{GE} = 0V$	1200		V
$V_{GE(th)}$	$I_C = 250\mu A$, $V_{CE} = V_{GE}$	3.0		5.0 V
I_{CES}	$V_{CE} = V_{CES}$, $V_{GE} = 0V$ $T_J = 125^\circ C$			50 μA 500 μA
I_{GES}	$V_{CE} = 0V$, $V_{GE} = \pm 20V$			± 100 nA
$V_{CE(sat)}$	$I_C = 50A$, $V_{GE} = 15V$, Note 1 $T_J = 150^\circ C$	4.2		3.5 V V

Symbol	Test Conditions	Characteristic Values		
		Min.	Typ.	Max.
g_{fs}	$I_C = 50A, V_{CE} = 10V$, Note 1	20	32	S
C_{ies}	$V_{CE} = 25V, V_{GE} = 0V, f = 1MHz$		3100	pF
C_{oes}			230	pF
C_{res}			66	pF
$Q_{g(on)}$	$I_C = 50A, V_{GE} = 15V, V_{CE} = 0.5 \cdot V_{CES}$		142	nC
Q_{ge}			23	nC
Q_{gc}			60	nC
$t_{d(on)}$	Inductive load, $T_J = 25^\circ C$ $I_C = 50A, V_{GE} = 15V$ $V_{CE} = 0.5 \cdot V_{CES}, R_G = 5\Omega$ Note 2		28	ns
t_{ri}			62	ns
E_{on}			3.0	mJ
$t_{d(off)}$			133	ns
t_{fi}			43	ns
E_{off}			1.0	1.7 mJ
$t_{d(on)}$	Inductive load, $T_J = 150^\circ C$ $I_C = 50A, V_{GE} = 15V$ $V_{CE} = 0.5 \cdot V_{CES}, R_G = 5\Omega$ Note 2		28	ns
t_{ri}			68	ns
E_{on}			6.0	mJ
$t_{d(off)}$			160	ns
t_{fi}			60	ns
E_{off}			1.4	mJ
R_{thJC}				0.43 °C/W
R_{thCS}		0.15		°C/W

ISOPLUS247 (IXYR) Outline

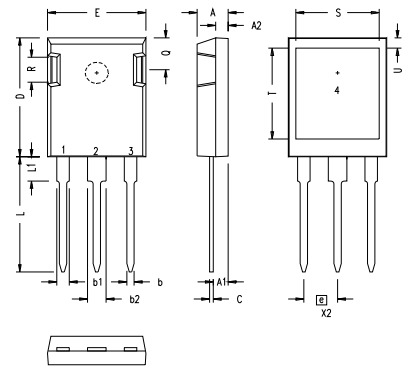

SYM	INCHES		MILLIMETERS	
	MIN	MAX	MIN	MAX
A	.190	.205	4.83	5.21
A1	.090	.100	2.29	2.54
A2	.075	.085	1.91	2.16
b	.045	.055	1.14	1.40
b1	.075	.084	1.91	2.13
b2	.115	.123	2.92	3.12
C	.024	.031	0.61	0.80
D	.819	.840	20.80	21.34
E	.620	.635	15.75	16.13
e	.215 BSC		5.45 BSC	
L	.780	.800	19.81	20.32
L1	.150	.170	3.81	4.32
Q	.220	.244	5.59	6.20
R	.170	.190	4.32	4.83
S	.520	.540	13.21	13.72
T	.620	.640	15.75	16.26
U	.065	.080	1.65	2.03

- 1 - Gate
- 2,4 - Collector
- 3 - Emitter

Reverse Diode (FRED)

Symbol	Test Conditions	Characteristic Value		
		Min.	Typ.	Max.
V_F	$I_F = 30A, V_{GE} = 0V$, Note 1			3.00 V
		$T_J = 150^\circ C$	1.75	V
I_{RM}	$I_F = 30A, V_{GE} = 0V, -di_F/dt = 100A/\mu s, V_R = 600V$	$T_J = 100^\circ C$		9 A
t_{rr}		$T_J = 100^\circ C$	195	ns
R_{thJC}				1.10 °C/W

Notes:

- Pulse test, $t \leq 300\mu s$, duty cycle, $d \leq 2\%$.
- Switching times & energy losses may increase for higher V_{CE} (clamp), T_J or R_G .

IXYS Reserves the Right to Change Limits, Test Conditions, and Dimensions.

IXYS MOSFETs and IGBTs are covered by one or more of the following U.S. patents:	4,835,592	4,931,844	5,049,961	5,237,481	6,162,665	6,404,065 B1	6,683,344	6,727,585	7,005,734 B2	7,157,338B2
	4,860,072	5,017,508	5,063,307	5,381,025	6,259,123 B1	6,534,343	6,710,405 B2	6,759,692	7,063,975 B2	
	4,881,106	5,034,796	5,187,117	5,486,715	6,306,728 B1	6,583,505	6,710,463	6,771,478 B2	7,071,537	

Fig. 1. Output Characteristics @ $T_J = 25^\circ\text{C}$

Fig. 2. Extended Output Characteristics @ $T_J = 25^\circ\text{C}$

Fig. 3. Output Characteristics @ $T_J = 150^\circ\text{C}$

Fig. 4. Dependence of $V_{CE(sat)}$ on Junction Temperature

Fig. 5. Collector-to-Emitter Voltage vs. Gate-to-Emitter Voltage

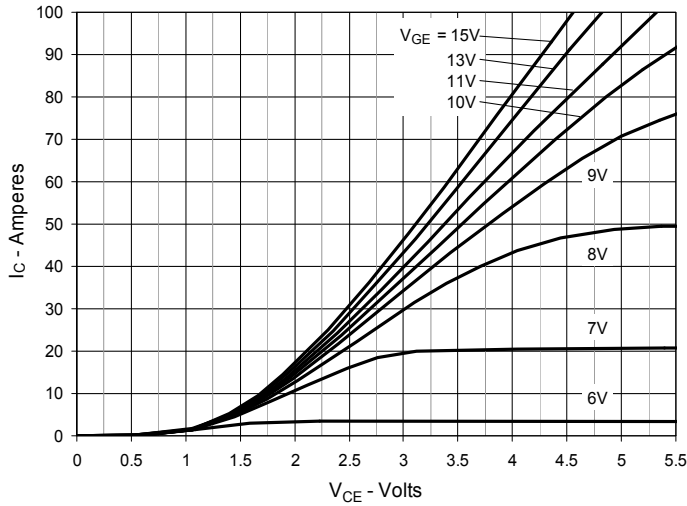
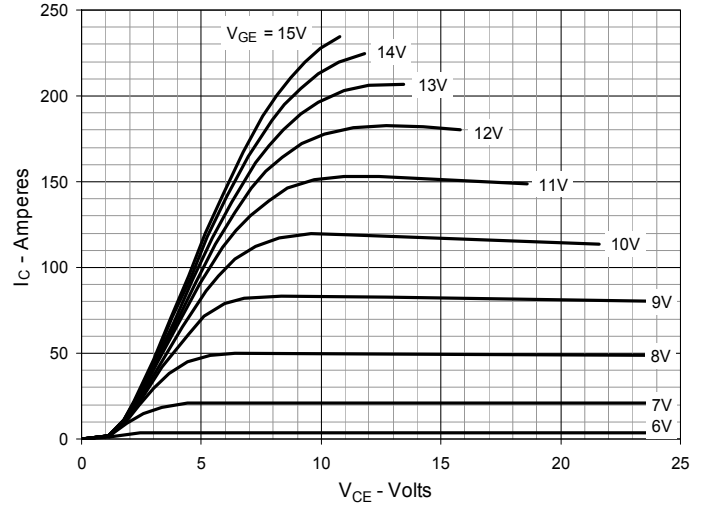
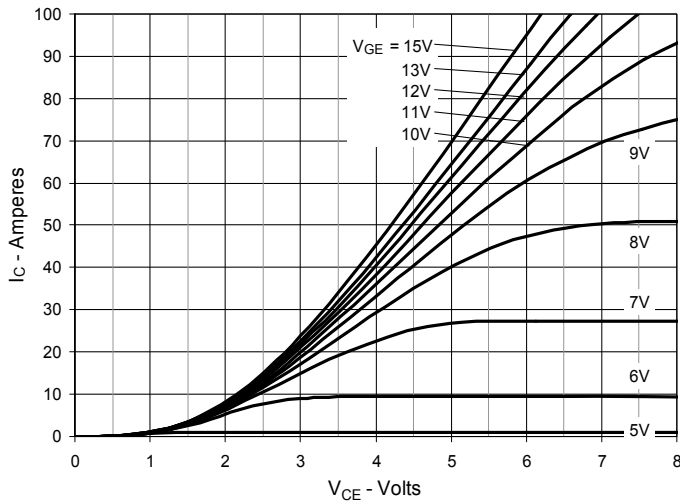
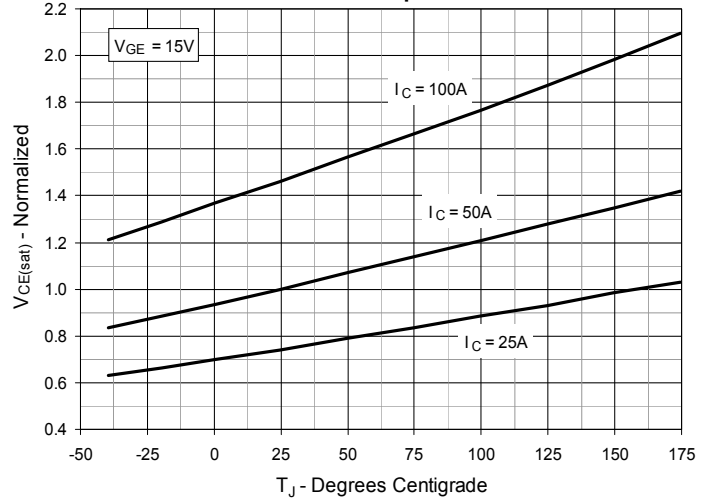
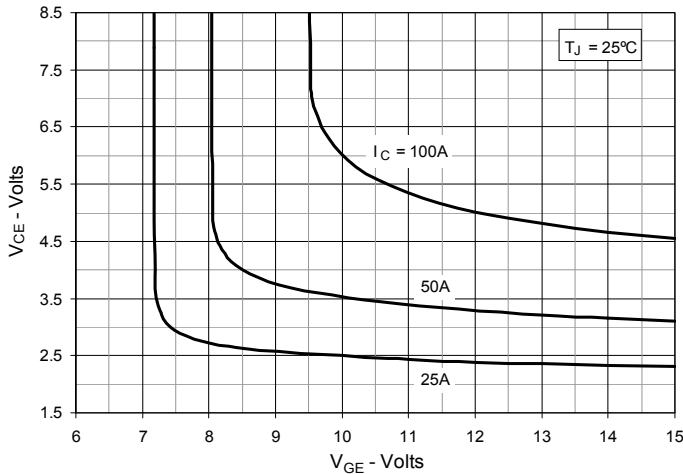
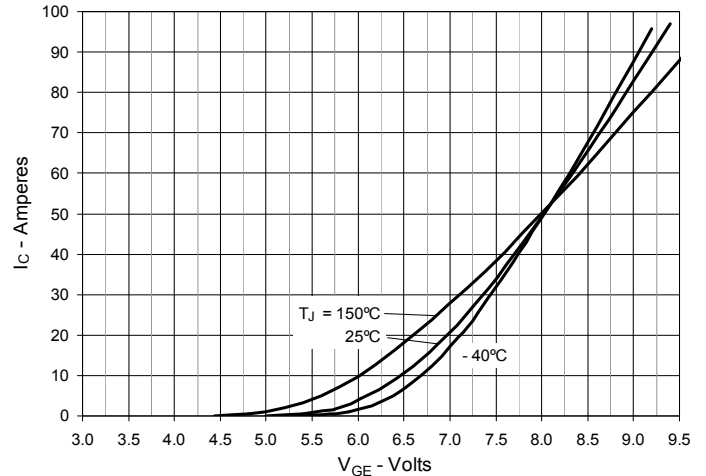
Fig. 6. Input Admittance

Fig. 7. Transconductance

Fig. 8. Gate Charge

Fig. 9. Capacitance

Fig. 10. Reverse-Bias Safe Operating Area

Fig. 11. Maximum Transient Thermal Impedance

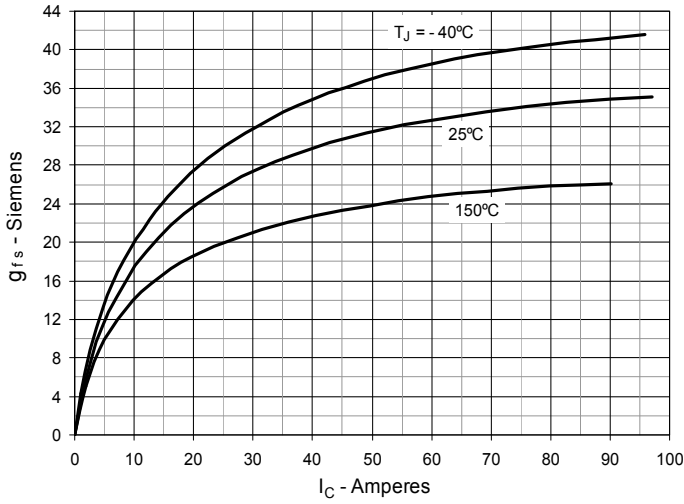
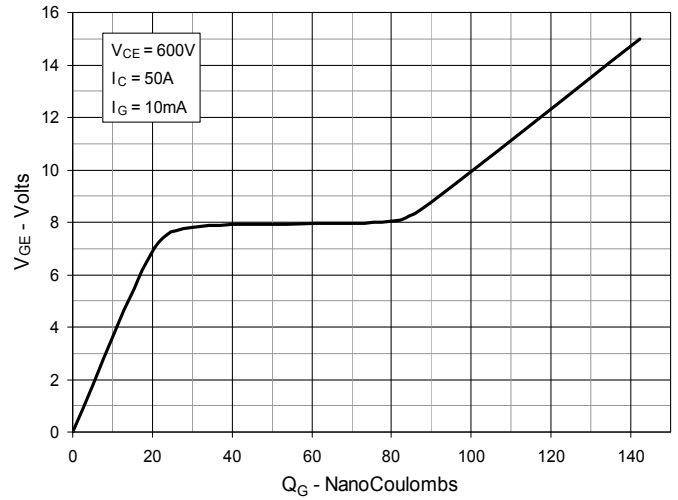
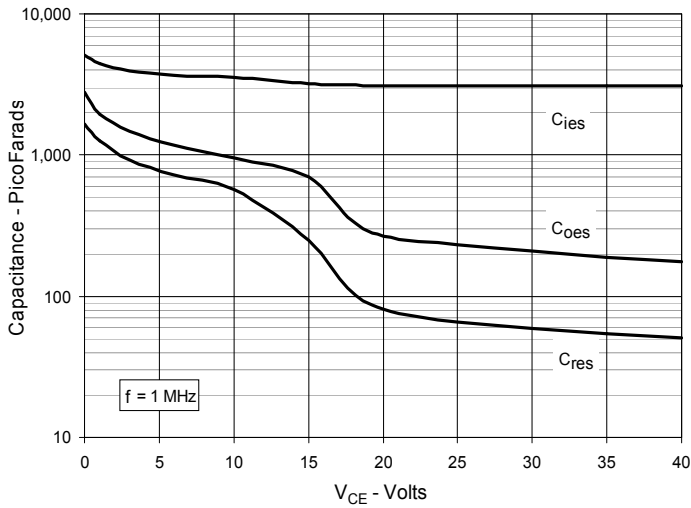
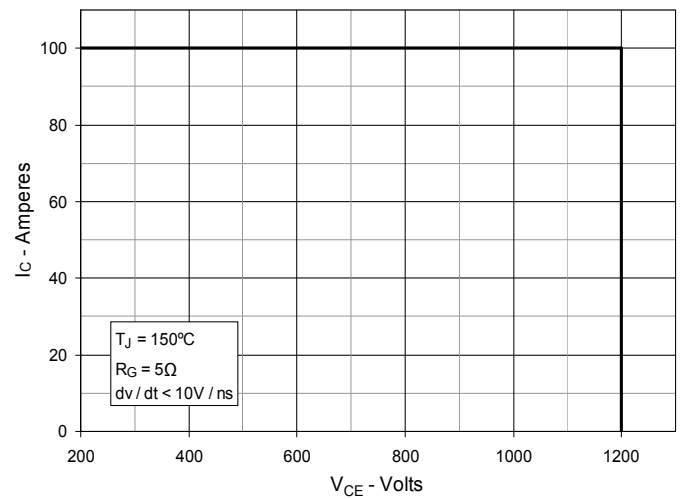
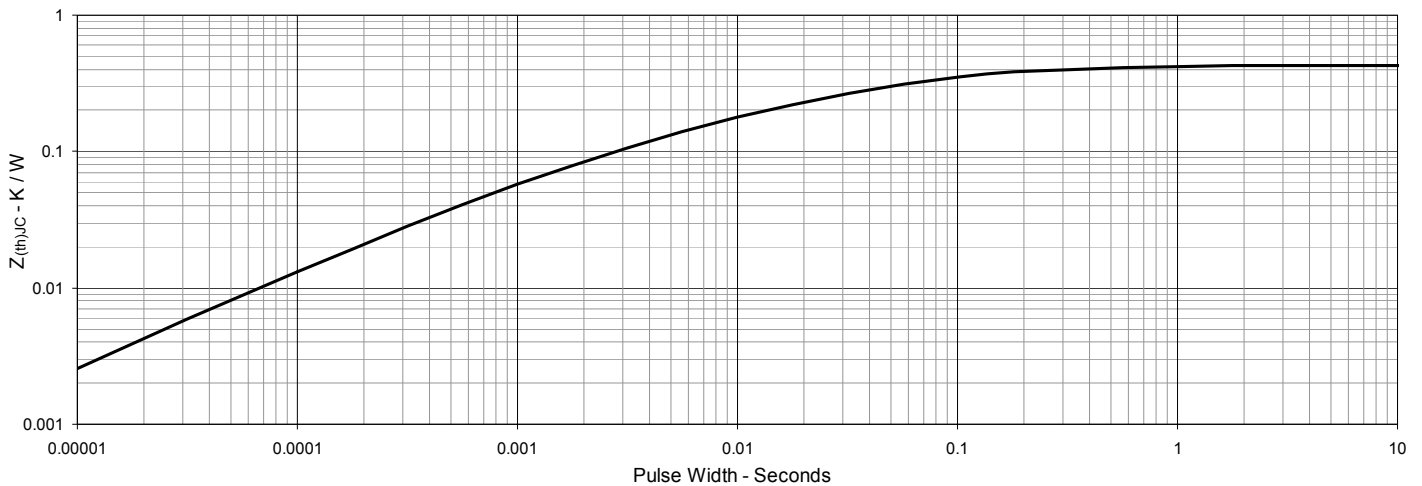
Fig. 12. Inductive Switching Energy Loss vs. Gate Resistance

Fig. 13. Inductive Switching Energy Loss vs. Collector Current

Fig. 14. Inductive Switching Energy Loss vs. Junction Temperature

Fig. 15. Inductive Turn-off Switching Times vs. Gate Resistance

Fig. 16. Inductive Turn-off Switching Times vs. Collector Current

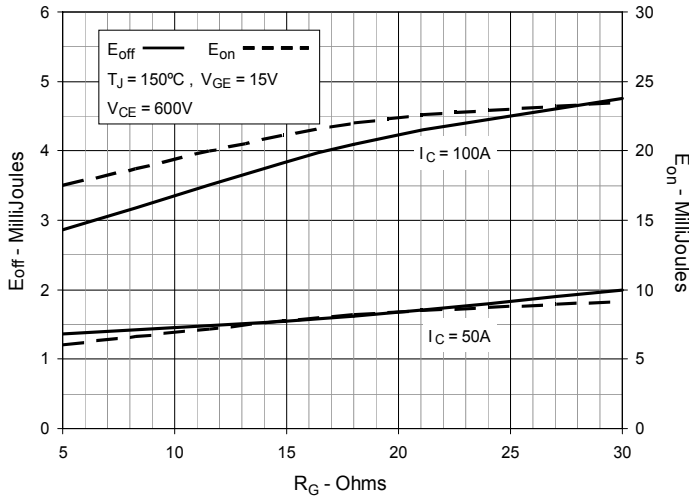
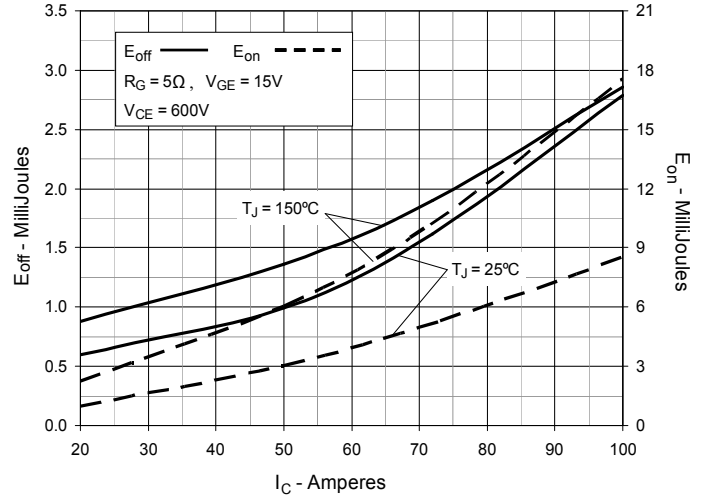
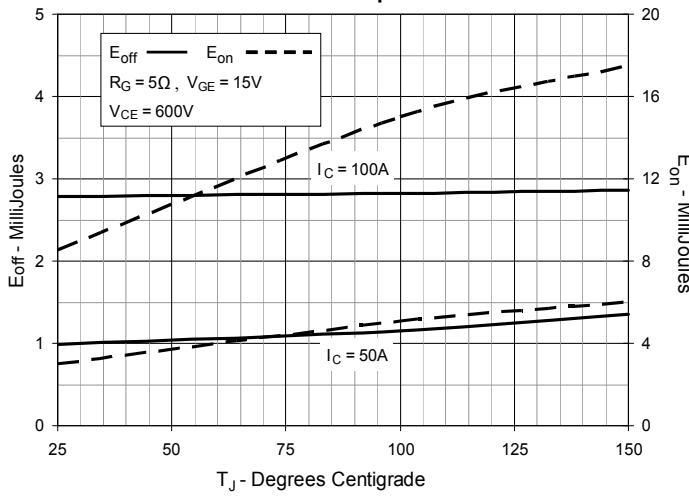
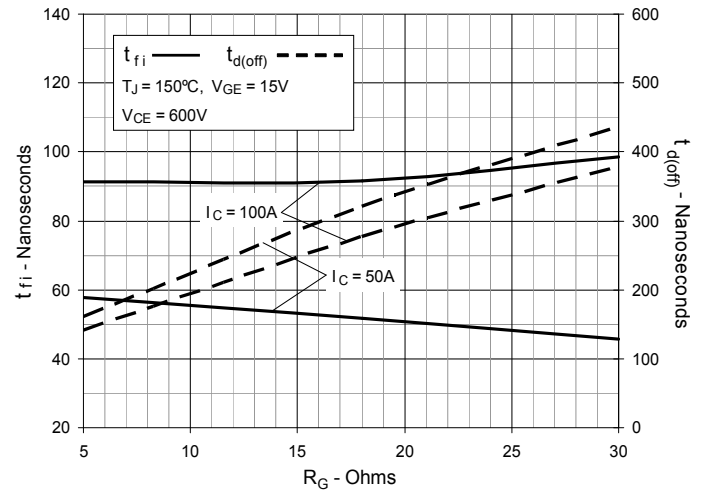
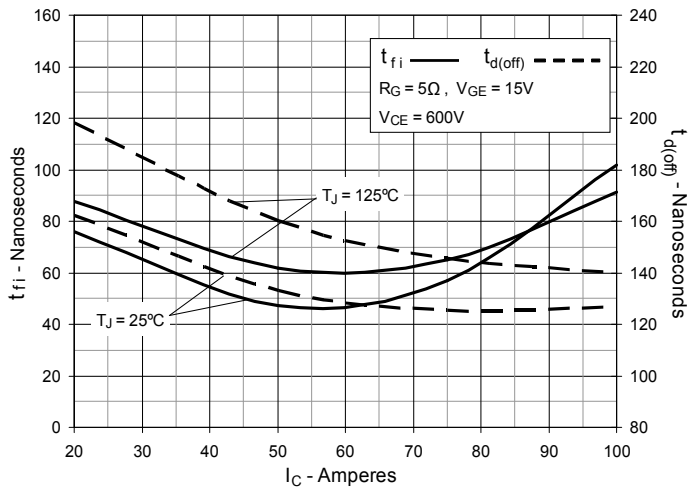
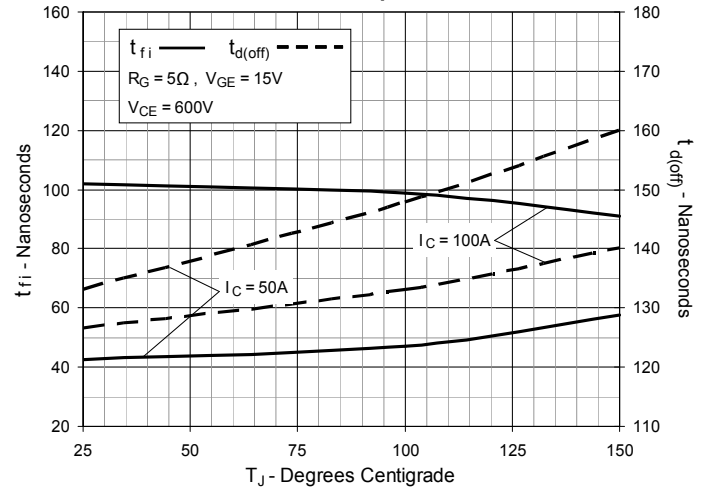
Fig. 17. Inductive Turn-off Switching Times vs. Junction Temperature

Fig. 18. Inductive Turn-on Switching Times vs. Gate Resistance

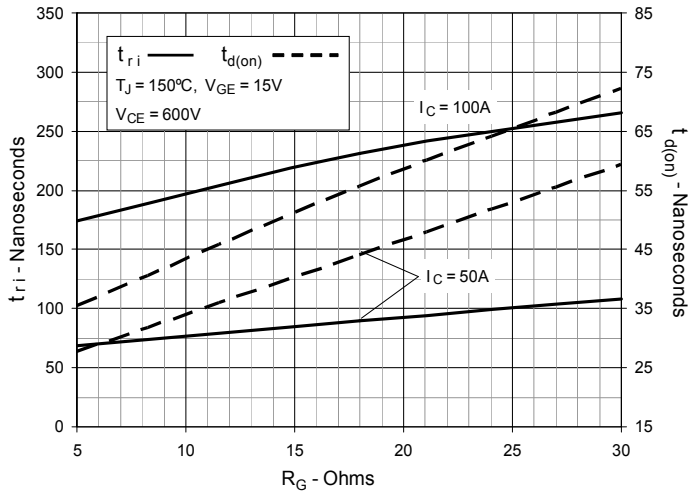

Fig. 19. Inductive Turn-on Switching Times vs. Collector Current

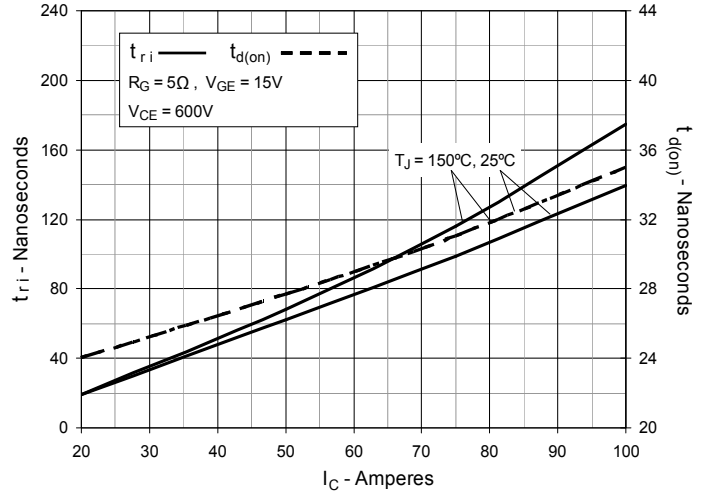

Fig. 20. Inductive Turn-on Switching Times vs. Junction Temperature

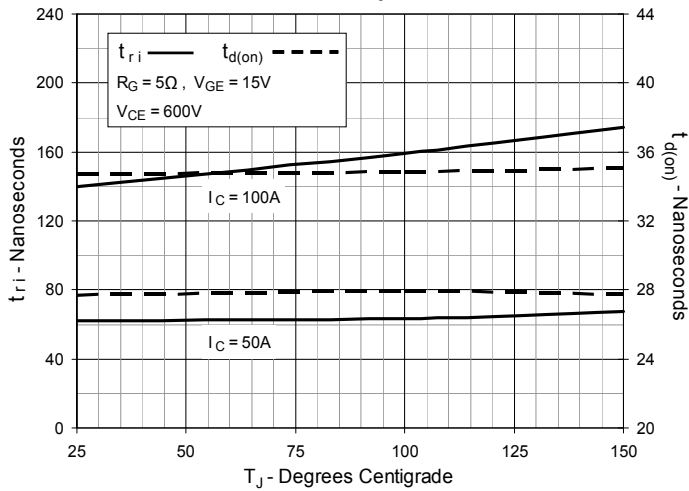

Fig. 21. Maximum Transient Thermal Impedance (Diode)

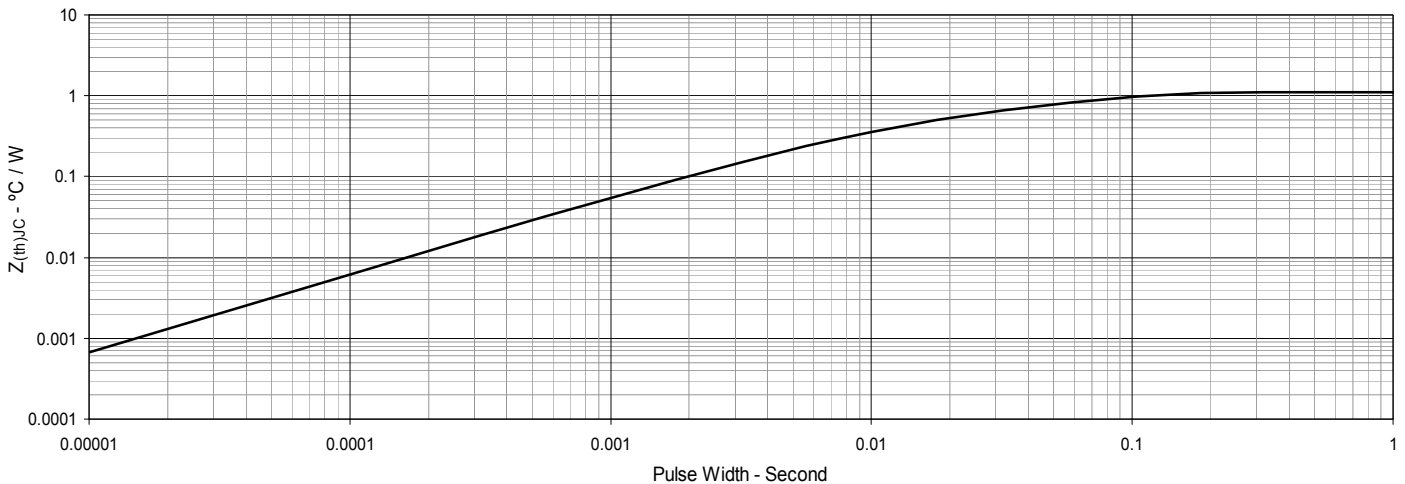
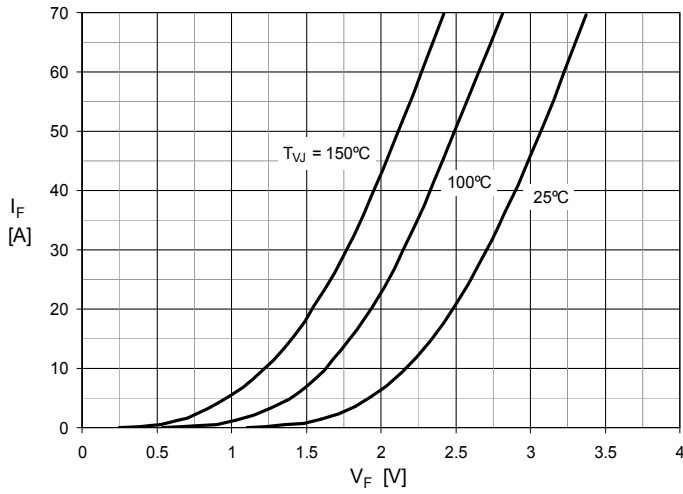
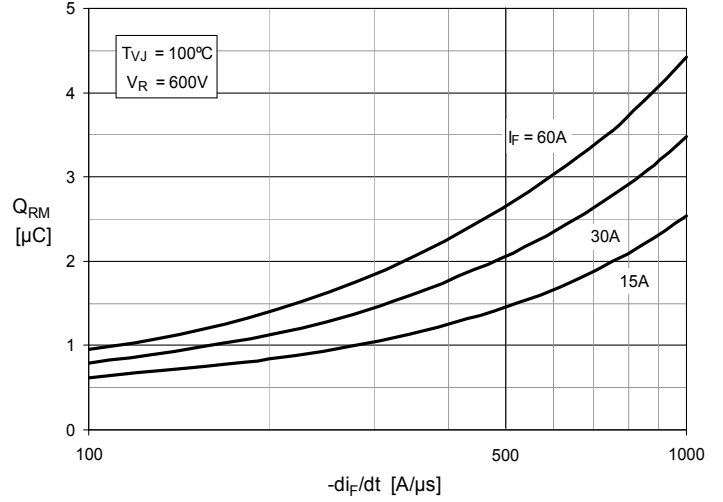
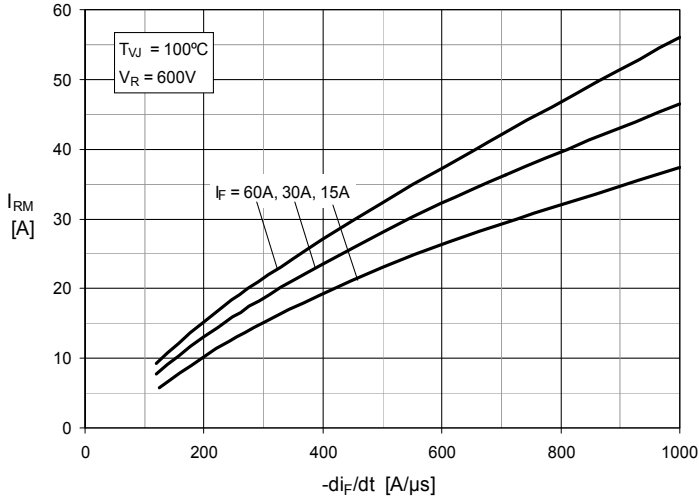
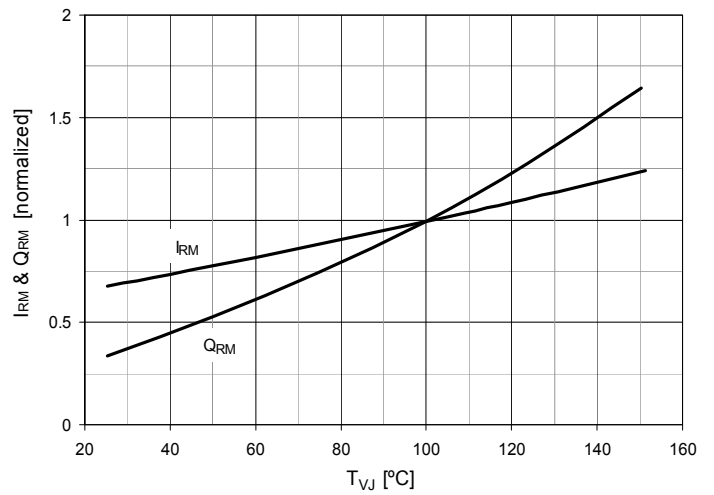
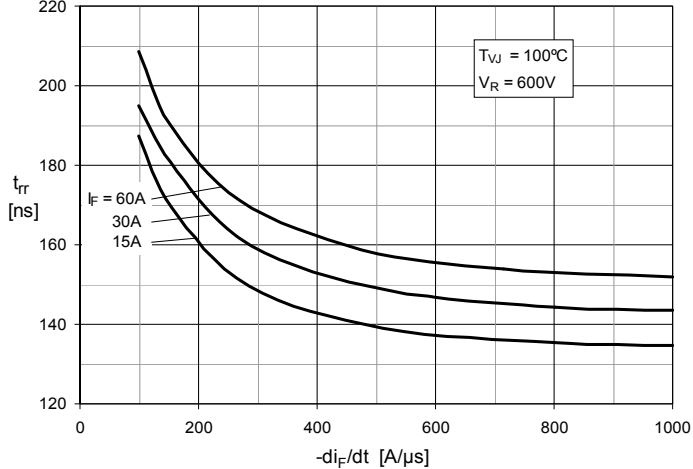
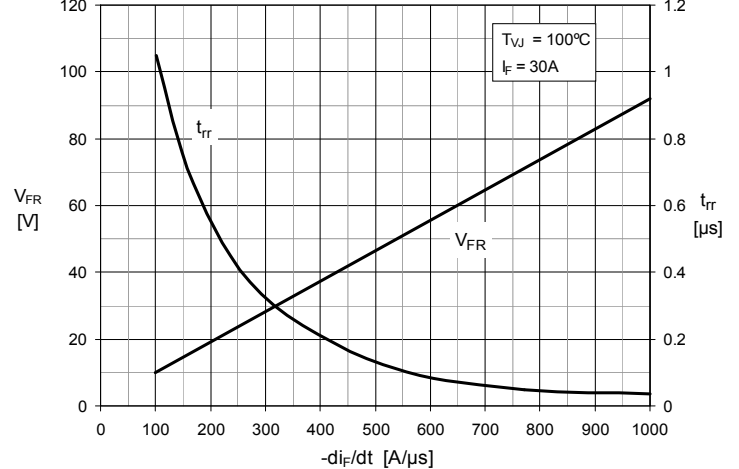

Fig. 22. Forward Current I_F vs V_F

Fig. 23. Reverse Recovery Charge Q_{RM} vs. $-di_F/dt$

Fig. 24. Peak Reverse Current I_{RM} vs. $-di_F/dt$

Fig. 25. Dynamic Parameters Q_{RM} , I_{RM} vs. T_{VJ}

Fig. 26. Recovery Time t_{rr} vs. $-di_F/dt$

Fig. 27. Peak Forward Voltage V_{FR} , t_{rr} vs $-di_F/dt$



Disclaimer Notice - Information furnished is believed to be accurate and reliable. However, users should independently evaluate the suitability of and test each product selected for their own applications. Littelfuse products are not designed for, and may not be used in, all applications. Read complete Disclaimer Notice at www.littelfuse.com/disclaimer-electronics.