

XPT™ 900V IGBT GenX3™

IXYH60N90C3

High-Speed IGBT
for 20-50 kHz Switching

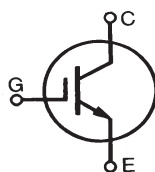

$$\begin{aligned} V_{CES} &= 900V \\ I_{C110} &= 60A \\ V_{CE(sat)} &\leq 2.9V \\ t_{fi(typ)} &= 88ns \end{aligned}$$

| Symbol | Test Conditions | Maximum Ratings | |
|-------------------------------|--------------------------------------------------------------------------------------------|-------------------------------------------|------------------|
| V_{CES} | $T_J = 25^\circ\text{C to } 175^\circ\text{C}$ | 900 | V |
| V_{CGR} | $T_J = 25^\circ\text{C to } 175^\circ\text{C}, R_{GE} = 1M\Omega$ | 900 | V |
| V_{GES} | Continuous | ± 20 | V |
| V_{GEM} | Transient | ± 30 | V |
| I_{C25} | $T_C = 25^\circ\text{C}$ (Chip Capability) | 140 | A |
| I_{C110} | $T_C = 110^\circ\text{C}$ | 60 | A |
| I_{CM} | $T_C = 25^\circ\text{C}, 1\text{ms}$ | 310 | A |
| SSOA (RBSOA) | $V_{GE} = 15\text{V}, T_{VJ} = 150^\circ\text{C}, R_G = 3\Omega$ Clamped Inductive Load | $I_{CM} = 120$ @ $V_{CE} \leq V_{CES}$ | A |
| P_C | $T_C = 25^\circ\text{C}$ | 750 | W |
| T_J | | -55 ... +175 | $^\circ\text{C}$ |
| T_{JM} | | 175 | $^\circ\text{C}$ |
| T_{stg} | | -55 ... +175 | $^\circ\text{C}$ |
| T_L | Maximum Lead Temperature for Soldering | 300 | $^\circ\text{C}$ |
| T_{SOLD} | 1.6 mm (0.062in.) from Case for 10s | 260 | $^\circ\text{C}$ |
| M_d | Mounting Torque | 1.13/10 | Nm/lb.in. |
| Weight | | 6 | g |

TO-247 AD

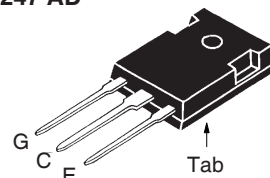

G = Gate C = Collector
E = Emitter Tab = Collector

Features

- Optimized for Low Switching Losses
- Square RBSOA
- Positive Thermal Coefficient of $V_{ce(sat)}$
- International Standard Package

Advantages

- High Power Density
- Low Gate Drive Requirement

Applications

- High Frequency Power Inverters
- UPS
- Motor Drives
- SMPS
- PFC Circuits
- Battery Chargers
- Welding Machines
- Lamp Ballasts

| Symbol | Test Conditions ($T_J = 25^\circ\text{C}$, Unless Otherwise Specified) | Characteristic Values | | |
|---------------|-------------------------------------------------------------------------------|-----------------------|------------|---------------------------------------|
| | | Min. | Typ. | Max. |
| BV_{CES} | $I_C = 250\mu\text{A}, V_{GE} = 0\text{V}$ | 950 | | V |
| $V_{GE(th)}$ | $I_C = 250\mu\text{A}, V_{CE} = V_{GE}$ | 3.5 | | 5.5 V |
| I_{CES} | $V_{CE} = V_{CES}, V_{GE} = 0\text{V}$ $T_J = 150^\circ\text{C}$ | | | 25 μA 750 μA |
| I_{GES} | $V_{CE} = 0\text{V}, V_{GE} = \pm 20\text{V}$ | | | ± 100 nA |
| $V_{CE(sat)}$ | $I_C = 60\text{A}, V_{GE} = 15\text{V}$, Note 1 $T_J = 150^\circ\text{C}$ | | 2.4 2.9 | 2.9 V V |

| Symbol | Test Conditions ($T_J = 25^\circ\text{C}$ Unless Otherwise Specified) | Characteristic Values | | |
|--------------|-----------------------------------------------------------------------------------------------------------------------------------------------------------------|-----------------------|------|---------------------------|
| | | Min. | Typ. | Max. |
| g_{fs} | $I_C = 60\text{A}, V_{CE} = 10\text{V}$, Note 1 | 20 | 34 | S |
| C_{ies} | $V_{CE} = 25\text{V}, V_{GE} = 0\text{V}, f = 1\text{MHz}$ | | 3285 | pF |
| C_{oes} | | | 175 | pF |
| C_{res} | | | 56 | pF |
| $Q_{g(on)}$ | $I_C = 60\text{A}, V_{GE} = 15\text{V}, V_{CE} = 0.5 \cdot V_{CES}$ | | 107 | nC |
| Q_{ge} | | | 30 | nC |
| Q_{gc} | | | 50 | nC |
| $t_{d(on)}$ | Inductive load, $T_J = 25^\circ\text{C}$ $I_C = 60\text{A}, V_{GE} = 15\text{V}$ $V_{CE} = 0.5 \cdot V_{CES}, R_G = 3\Omega$ Note 2 | | 30 | ns |
| t_{ri} | | | 77 | ns |
| E_{on} | | | 2.70 | mJ |
| $t_{d(off)}$ | | | 87 | ns |
| t_{fi} | | | 88 | ns |
| E_{off} | | 1.55 | 2.50 | mJ |
| $t_{d(on)}$ | Inductive load, $T_J = 150^\circ\text{C}$ $I_C = 60\text{A}, V_{GE} = 15\text{V}$ $V_{CE} = 0.5 \cdot V_{CES}, R_G = 3\Omega$ Note 2 | | 30 | ns |
| t_{ri} | | | 74 | ns |
| E_{on} | | | 4.70 | mJ |
| $t_{d(off)}$ | | | 103 | ns |
| t_{fi} | | | 165 | ns |
| E_{off} | | 2.15 | mJ | |
| R_{thJC} | | | 0.20 | $^\circ\text{C}/\text{W}$ |
| R_{thCS} | | 0.21 | | $^\circ\text{C}/\text{W}$ |

TO-247 (IXYH) Outline

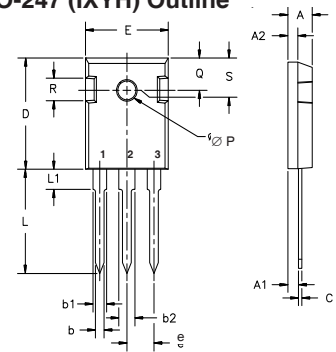

Terminals: 1 - Gate 2 - Collector
3 - Emitter

| Dim. | Millimeter | | Inches | |
|----------------|------------|-------|--------|-------|
| | Min. | Max. | Min. | Max. |
| A | 4.7 | 5.3 | .185 | .209 |
| A ₁ | 2.2 | 2.54 | .087 | .102 |
| A ₂ | 2.2 | 2.6 | .059 | .098 |
| b | 1.0 | 1.4 | .040 | .055 |
| b ₁ | 1.65 | 2.13 | .065 | .084 |
| b ₂ | 2.87 | 3.12 | .113 | .123 |
| C | .4 | .8 | .016 | .031 |
| D | 20.80 | 21.46 | .819 | .845 |
| E | 15.75 | 16.26 | .610 | .640 |
| e | 5.20 | 5.72 | 0.205 | 0.225 |
| L | 19.81 | 20.32 | .780 | .800 |
| L1 | | 4.50 | | .177 |
| ∅P | 3.55 | 3.65 | .140 | .144 |
| Q | 5.89 | 6.40 | 0.232 | 0.252 |
| R | 4.32 | 5.49 | .170 | .216 |
| S | 6.15 | BSC | .242 | BSC |

Notes:

1. Pulse test, $t \leq 300\mu\text{s}$, duty cycle, $d \leq 2\%$.
2. Switching times & energy losses may increase for higher V_{CE} (clamp), T_J or R_G .

IXYS Reserves the Right to Change Limits, Test Conditions, and Dimensions.

| | | | | | | | | | | |
|----------------------------------------------------------------------------------|-----------|-----------|-----------|-----------|--------------|--------------|--------------|--------------|--------------|-------------|
| IXYS MOSFETs and IGBTs are covered by one or more of the following U.S. patents: | 4,835,592 | 4,931,844 | 5,049,961 | 5,237,481 | 6,162,665 | 6,404,065 B1 | 6,683,344 | 6,727,585 | 7,005,734 B2 | 7,157,338B2 |
| | 4,860,072 | 5,017,508 | 5,063,307 | 5,381,025 | 6,259,123 B1 | 6,534,343 | 6,710,405 B2 | 6,759,692 | 7,063,975 B2 | |
| | 4,881,106 | 5,034,796 | 5,187,117 | 5,486,715 | 6,306,728 B1 | 6,583,505 | 6,710,463 | 6,771,478 B2 | 7,071,537 | |

Fig. 1. Output Characteristics @ $T_J = 25^\circ\text{C}$

Fig. 2. Extended Output Characteristics @ $T_J = 25^\circ\text{C}$

Fig. 3. Output Characteristics @ $T_J = 150^\circ\text{C}$

Fig. 4. Dependence of $V_{CE(sat)}$ on Junction Temperature

Fig. 5. Collector-to-Emitter Voltage vs. Gate-to-Emitter Voltage

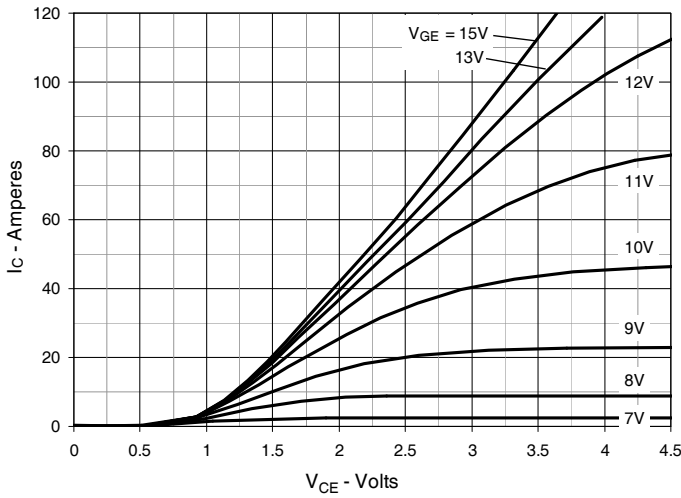
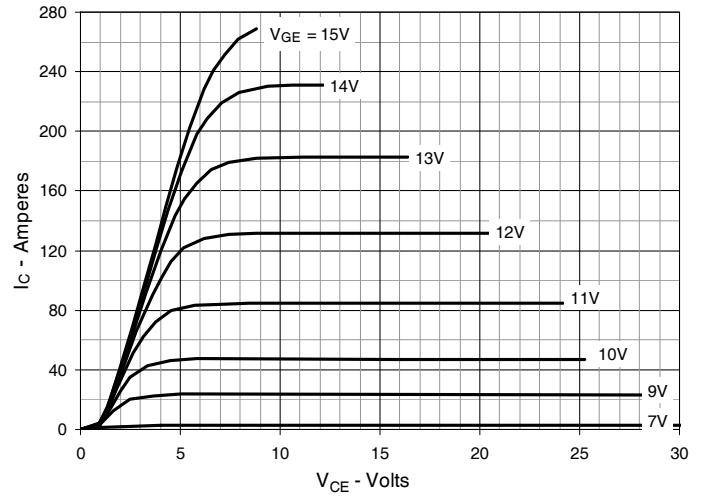
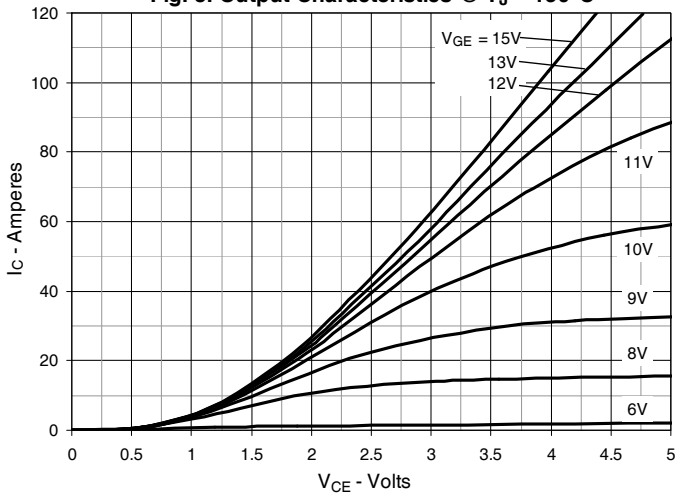
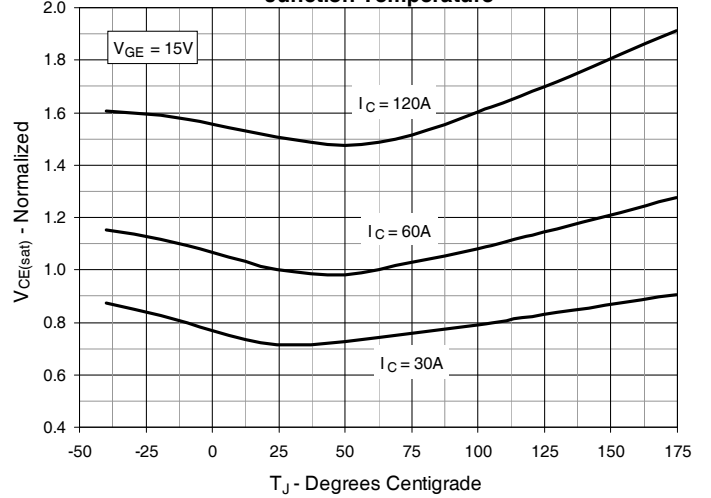
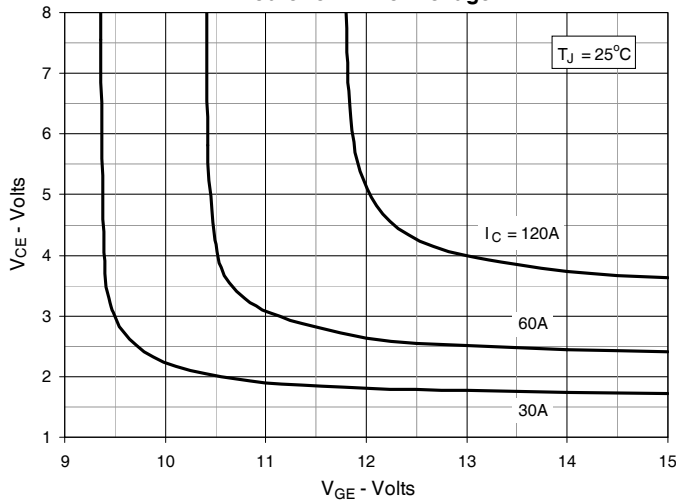
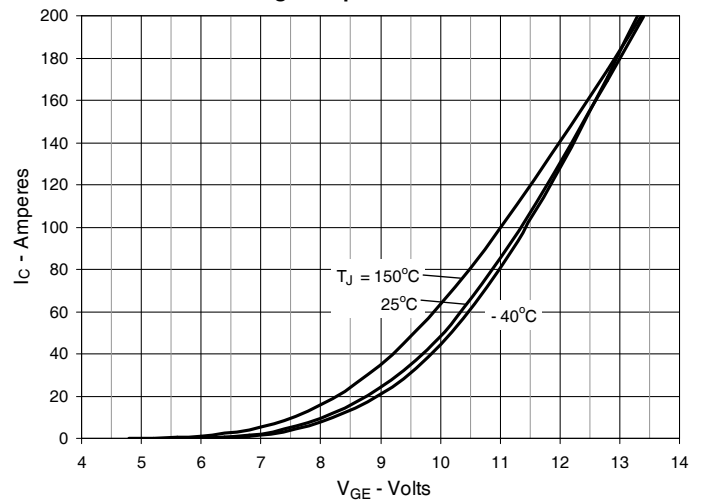
Fig. 6. Input Admittance

Fig. 7. Transconductance

Fig. 8. Gate Charge

Fig. 9. Capacitance

Fig. 10. Reverse-Bias Safe Operating Area

Fig. 11. Maximum Transient Thermal Impedance

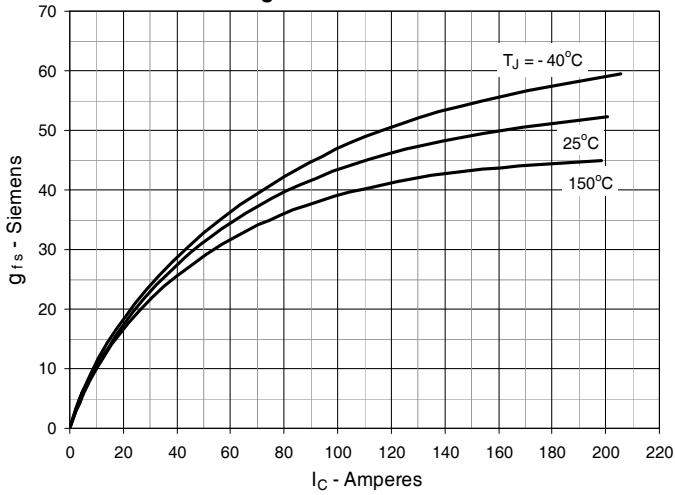
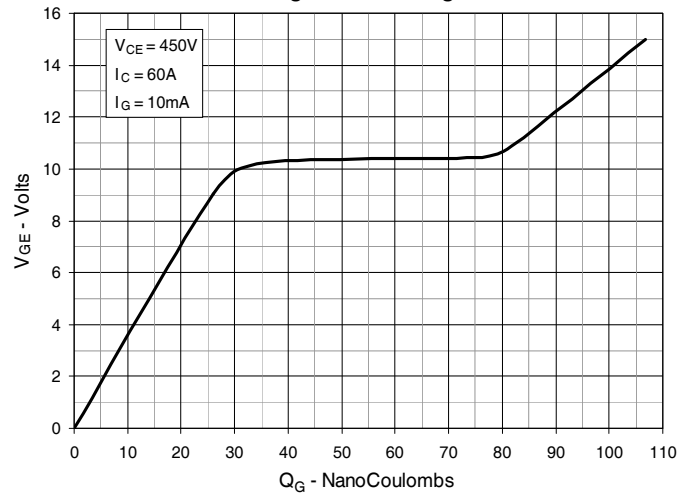
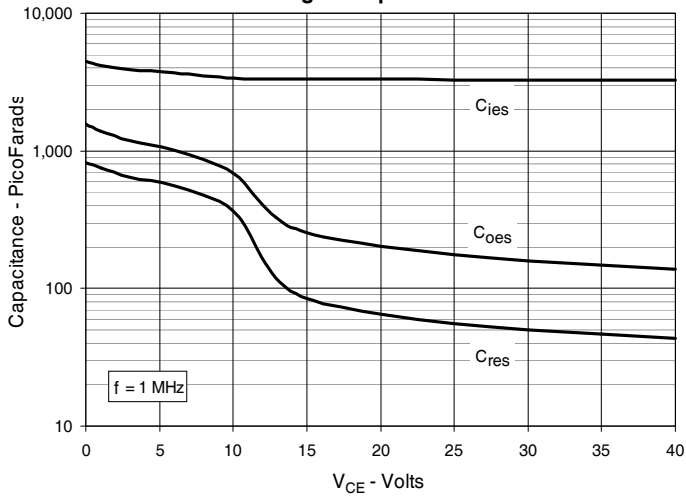
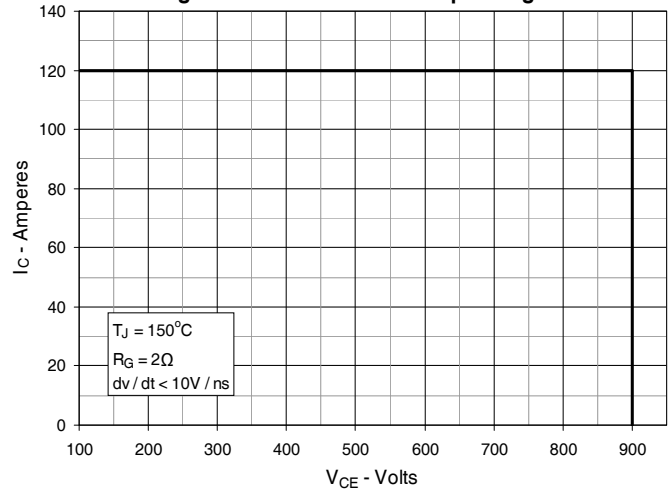
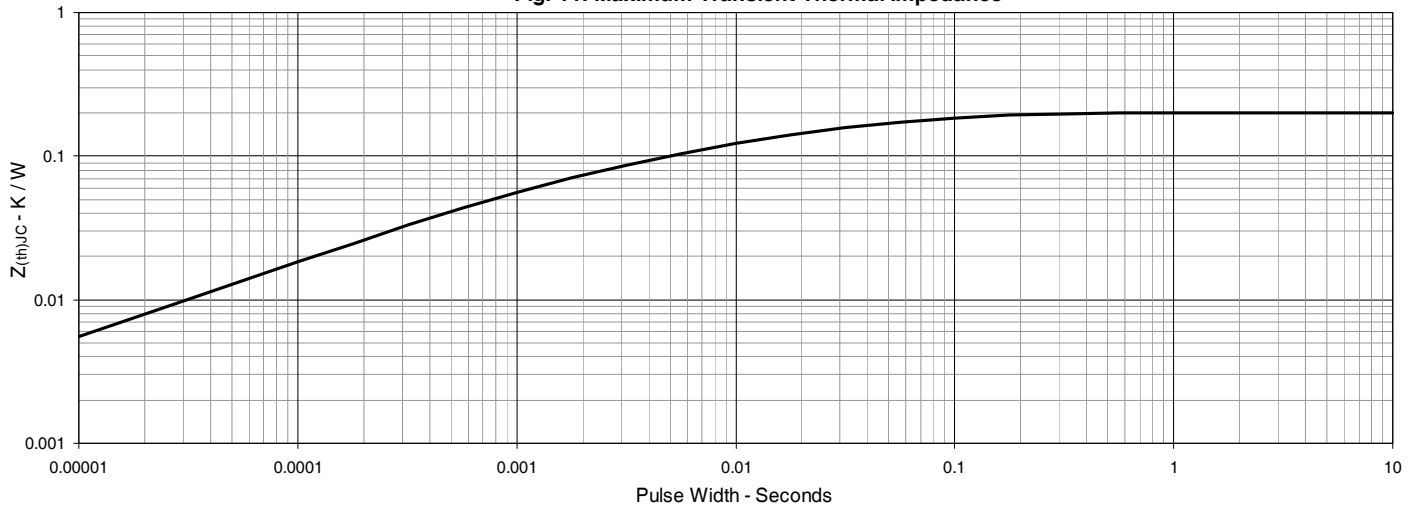
Fig. 12. Inductive Switching Energy Loss vs. Gate Resistance

Fig. 13. Inductive Switching Energy Loss vs. Collector Current

Fig. 14. Inductive Switching Energy Loss vs. Junction Temperature

Fig. 15. Inductive Turn-off Switching Times vs. Gate Resistance

Fig. 16. Inductive Turn-off Switching Times vs. Collector Current

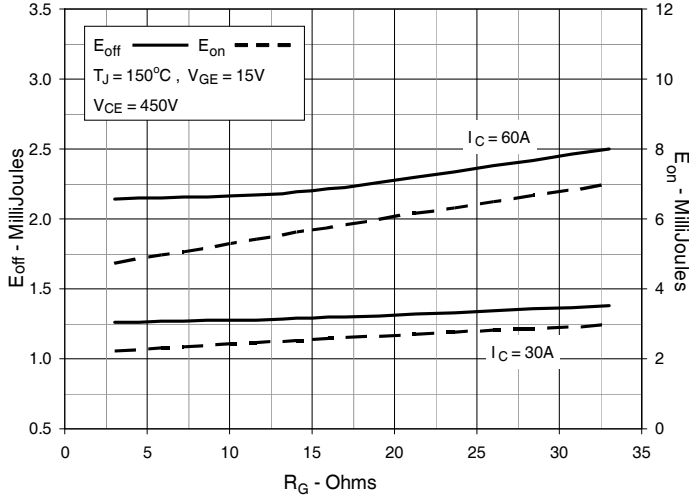
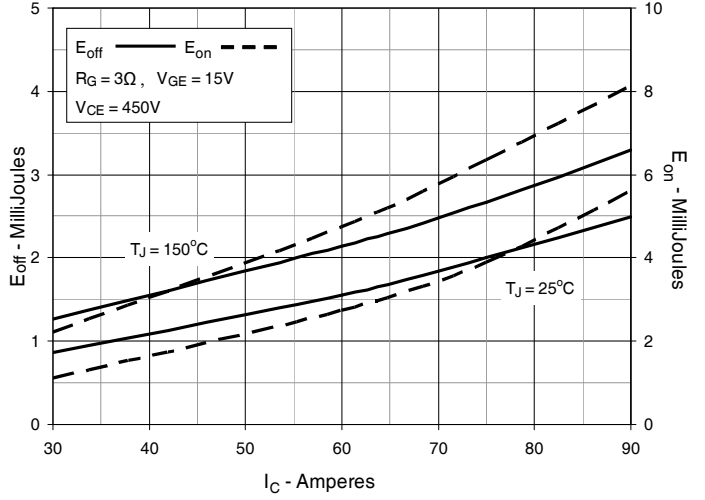
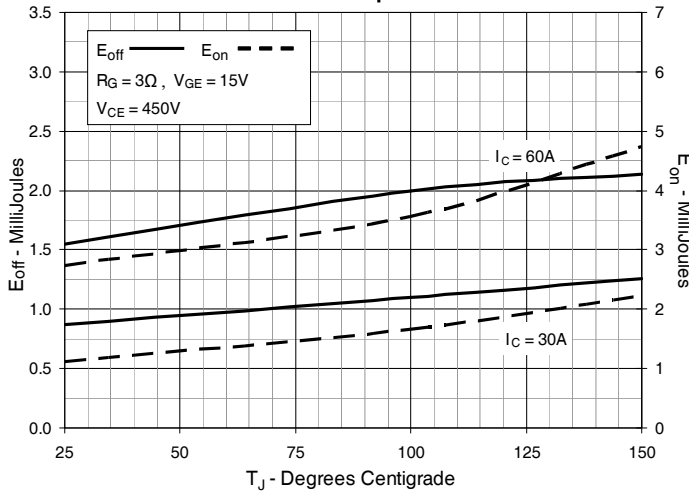
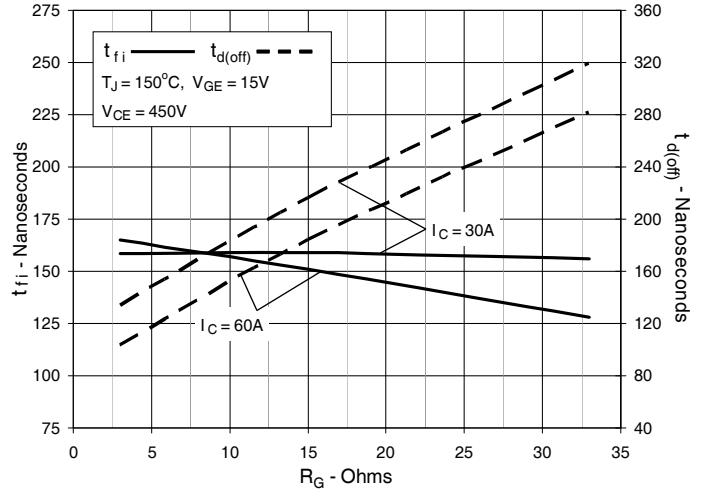
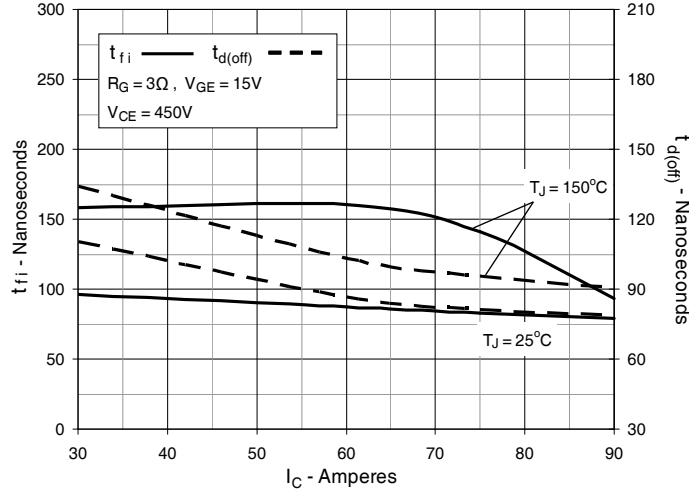
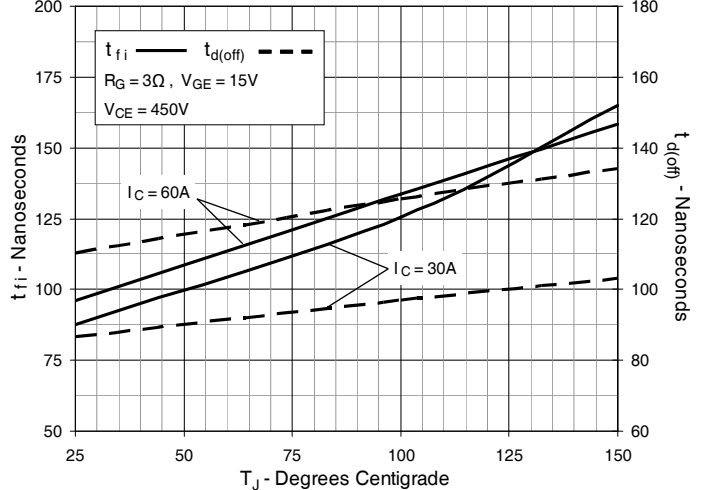
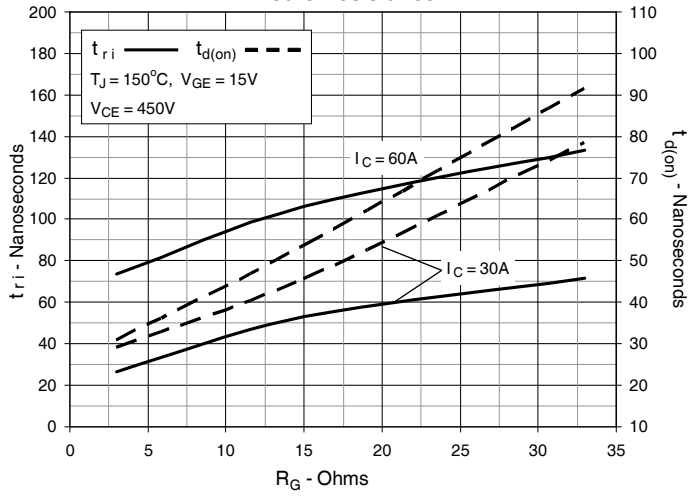
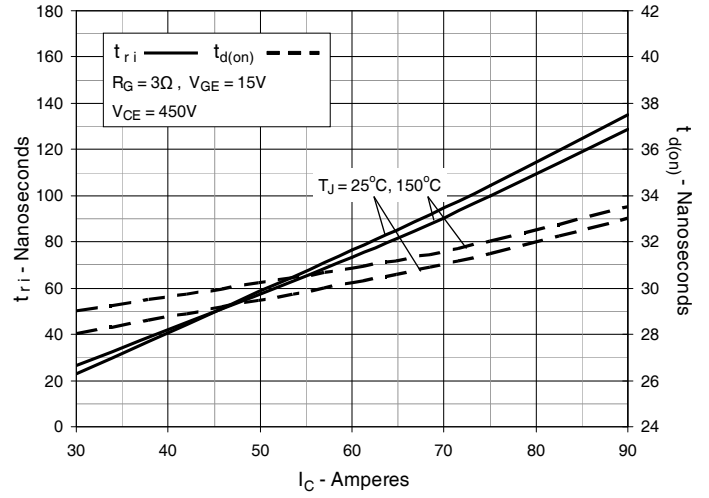
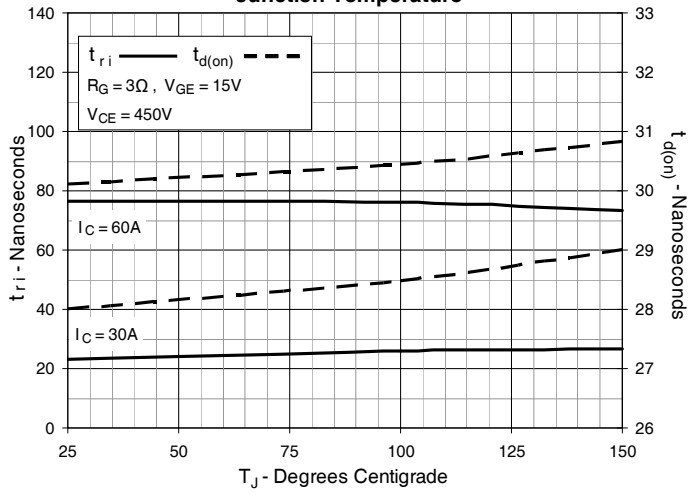
Fig. 17. Inductive Turn-off Switching Times vs. Junction Temperature

Fig. 18. Inductive Turn-on Switching Times vs. Gate Resistance

Fig. 19. Inductive Turn-on Switching Times vs. Collector Current

Fig. 20. Inductive Turn-on Switching Times vs. Junction Temperature



Disclaimer Notice - Information furnished is believed to be accurate and reliable. However, users should independently evaluate the suitability of and test each product selected for their own applications. Littelfuse products are not designed for, and may not be used in, all applications. Read complete Disclaimer Notice at www.littelfuse.com/disclaimer-electronics.