

# High Voltage XPT™ IGBT w/ Diode

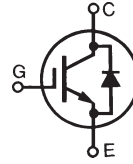
## IXYH16N170CV1

$$V_{CES} = 1700V$$

$$I_{C110} = 16A$$

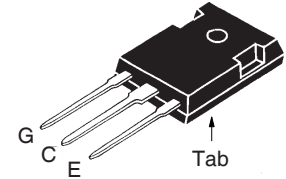
$$V_{CE(sat)} \leq 3.8V$$

$$t_{fi(typ)} = 120ns$$



Symbol	Test Conditions	Maximum Ratings	
$V_{CES}$	$T_J = 25^\circ C$ to $175^\circ C$	1700	V
$V_{CGR}$	$T_J = 25^\circ C$ to $175^\circ C$ , $R_{GE} = 1M\Omega$	1700	V
$V_{GES}$	Continuous	$\pm 20$	V
$V_{GEM}$	Transient	$\pm 30$	V
$I_{C25}$	$T_C = 25^\circ C$	40	A
$I_{C110}$	$T_C = 110^\circ C$	16	A
$I_{F110}$	$T_C = 110^\circ C$	22	A
$I_{CM}$	$T_C = 25^\circ C$ , 1ms	100	A
<b>SSOA (RBSOA)</b>	$V_{GE} = 15V$ , $T_{VJ} = 150^\circ C$ , $R_G = 10\Omega$ Clamped Inductive Load	$I_{CM} = 64$	A
		1360	V
$P_C$	$T_C = 25^\circ C$	310	W
$T_J$		-55 ... +175	$^\circ C$
$T_{JM}$		175	$^\circ C$
$T_{stg}$		-55 ... +175	$^\circ C$
$T_L$	Maximum Lead Temperature for Soldering	300	$^\circ C$
$T_{SOLD}$	1.6 mm (0.062in.) from Case for 10s	260	$^\circ C$
$M_d$	Mounting Torque	1.13/10	Nm/lb.in.
<b>Weight</b>		6	g

### TO-247 AD



G = Gate      C = Collector  
E = Emitter    Tab = Collector

### Features

- High Voltage Package
- High Blocking Voltage
- Low Saturation Voltage

### Advantages

- Low Gate Drive Requirement
- High Power Density

### Applications

- Switch-Mode and Resonant-Mode Power Supplies
- Uninterruptible Power Supplies (UPS)
- Laser Generators
- Capacitor Discharge Circuits
- AC Switches

Symbol	Test Conditions ( $T_J = 25^\circ C$ , Unless Otherwise Specified)	Characteristic Values		
		Min.	Typ.	Max.
$BV_{CES}$	$I_C = 250\mu A$ , $V_{GE} = 0V$	1700		V
$V_{GE(th)}$	$I_C = 250\mu A$ , $V_{CE} = V_{GE}$	3.0		5.0 V
$I_{CES}$	$V_{CE} = V_{CES}$ , $V_{GE} = 0V$			25 $\mu A$
	$V_{CE} = 0.8 \cdot V_{CES}$ , $V_{GE} = 0V$ , $T_J = 150^\circ C$			5 mA
$I_{GES}$	$V_{CE} = 0V$ , $V_{GE} = \pm 20V$			$\pm 100$ nA
$V_{CE(sat)}$	$I_C = 16A$ , $V_{GE} = 15V$ , Note 1 $T_J = 150^\circ C$		3.2	V
			4.4	V

Symbol Test Conditions ( $T_J = 25^\circ\text{C}$ Unless Otherwise Specified)		Characteristic Values		
		Min.	Typ.	Max.
$g_{fs}$	$I_C = 16\text{A}, V_{CE} = 10\text{V}$ , Note 1	7	12	S
$R_{Gi}$	Gate Input Resistance		7	$\Omega$
$C_{ies}$	$V_{CE} = 25\text{V}, V_{GE} = 0\text{V}, f = 1\text{MHz}$		1165	pF
$C_{oes}$			88	pF
$C_{res}$			23	pF
$Q_{g(on)}$	$I_C = 16\text{A}, V_{GE} = 15\text{V}, V_{CE} = 0.5 \cdot V_{CES}$		56	nC
$Q_{ge}$			7	nC
$Q_{gc}$			27	nC
$t_{d(on)}$	<b>Inductive load, <math>T_J = 25^\circ\text{C}</math></b> $I_C = 16\text{A}, V_{GE} = 15\text{V}$ $V_{CE} = 0.5 \cdot V_{CES}, R_G = 10\Omega$ Note 2		11	ns
$t_{ri}$			19	ns
$E_{on}$			2.10	mJ
$t_{d(off)}$			140	ns
$t_{fi}$			120	ns
$E_{off}$			1.50	mJ
$t_{d(on)}$	<b>Inductive load, <math>T_J = 150^\circ\text{C}</math></b> $I_C = 16\text{A}, V_{GE} = 15\text{V}$ $V_{CE} = 0.5 \cdot V_{CES}, R_G = 10\Omega$ Note 2		15	ns
$t_{ri}$			20	ns
$E_{on}$			2.90	mJ
$t_{d(off)}$			175	ns
$t_{fi}$			140	ns
$E_{off}$			1.95	mJ
$R_{thJC}$				0.48°C/W
$R_{thCS}$		0.21		°C/W

### Reverse Diode (FRED)

Symbol Test Conditions ( $T_J = 25^\circ\text{C}$ , Unless Otherwise Specified)		Characteristic Value		
		Min.	Typ.	Max.
$V_F$	$I_F = 16\text{A}, V_{GE} = 0\text{V}$ , Note 1 $T_J = 150^\circ\text{C}$		3.0	3.3 V
$I_{RM}$	$I_F = 16\text{A}, V_{GE} = 0\text{V}, -di_F/dt = 500\text{A}/\mu\text{s}$ $V_R = 1200\text{V}, T_J = 150^\circ\text{C}$		22	A
$t_{rr}$			150	ns
$R_{thJC}$				0.70 °C/W

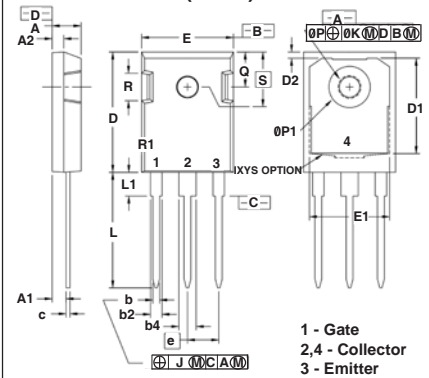
### Notes:

1. Pulse test,  $t \leq 300\mu\text{s}$ , duty cycle,  $d \leq 2\%$ .
2. Switching times & energy losses may increase for higher  $V_{CE}$ (clamp),  $T_J$  or  $R_G$ .

### ADVANCE TECHNICAL INFORMATION

The product presented herein is under development. The Technical Specifications offered are derived from a subjective evaluation of the design, based upon prior knowledge and experience, and constitute a "considered reflection" of the anticipated result. IXYS reserves the right to change limits, test conditions, and dimensions without notice.

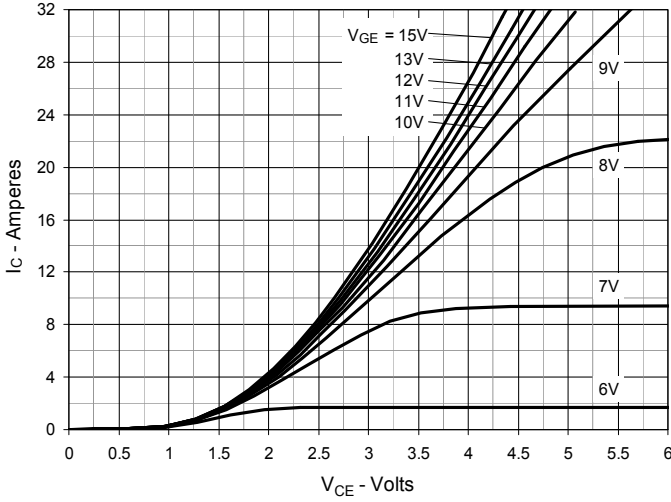
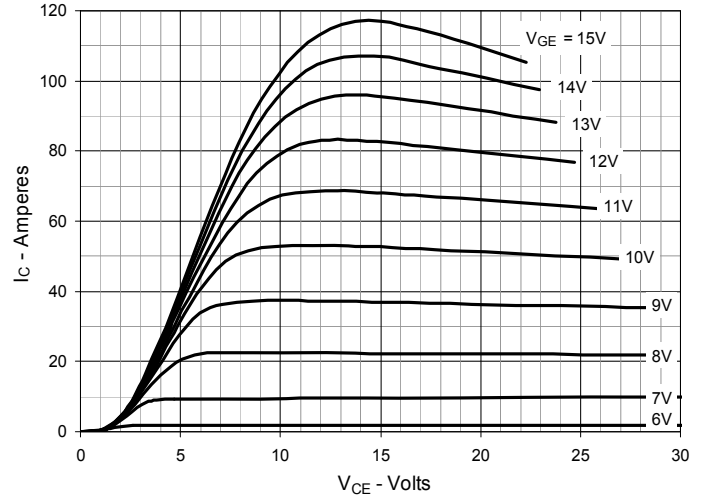
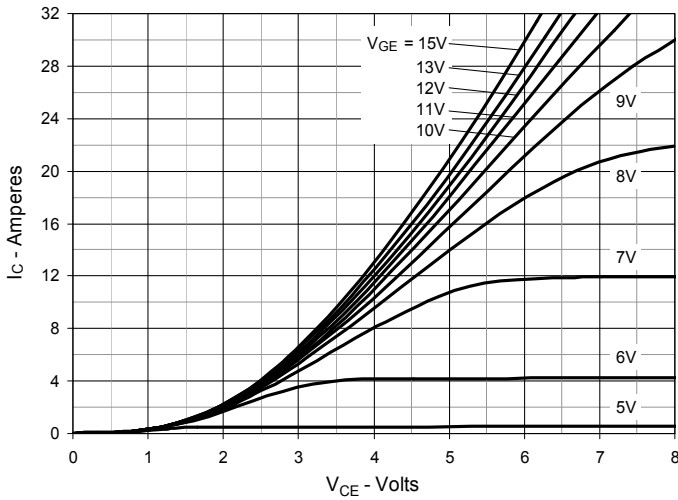
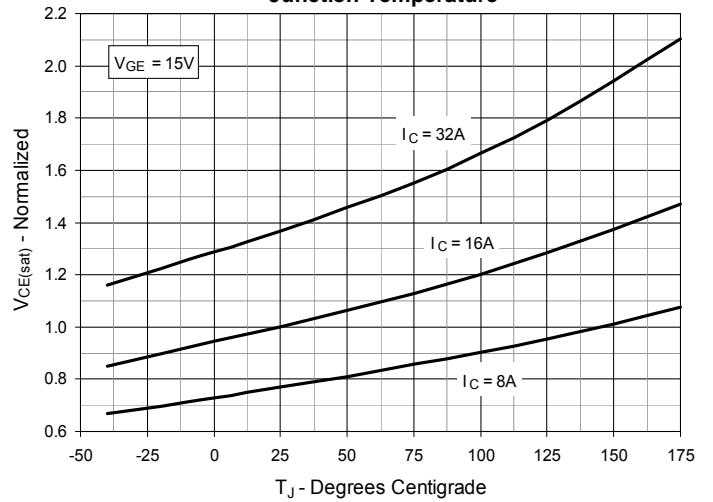
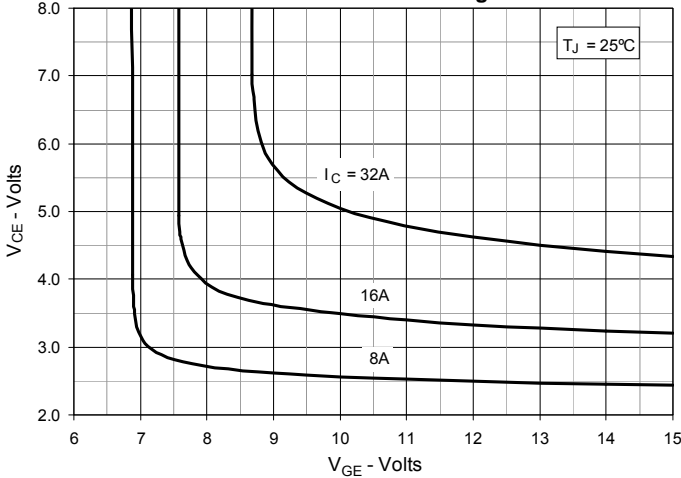
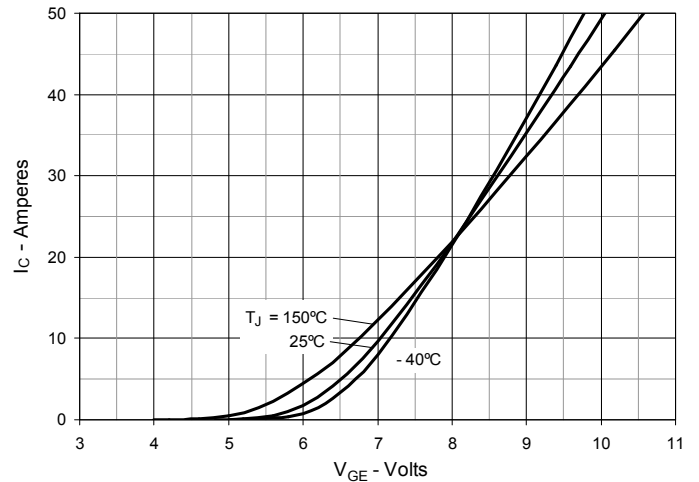
### TO-247 (IXYH) Outline

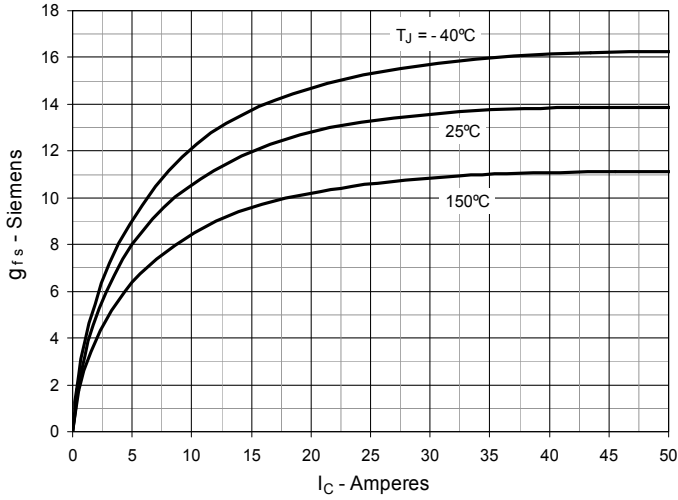
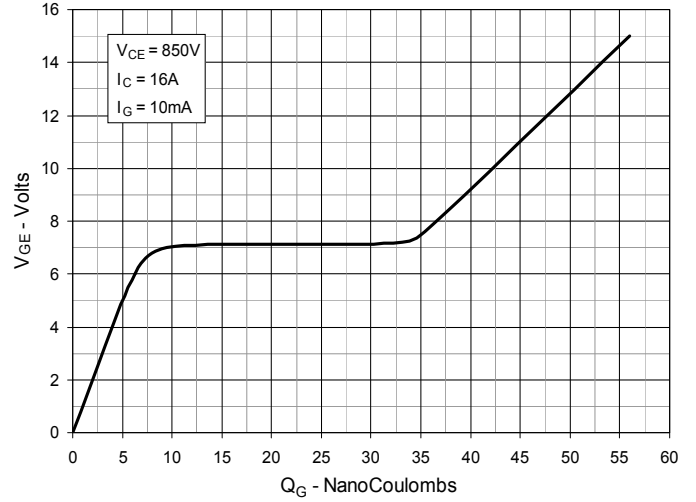
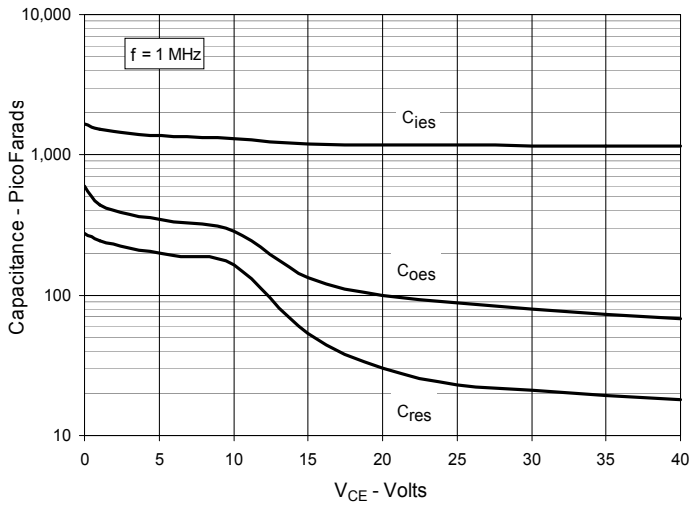
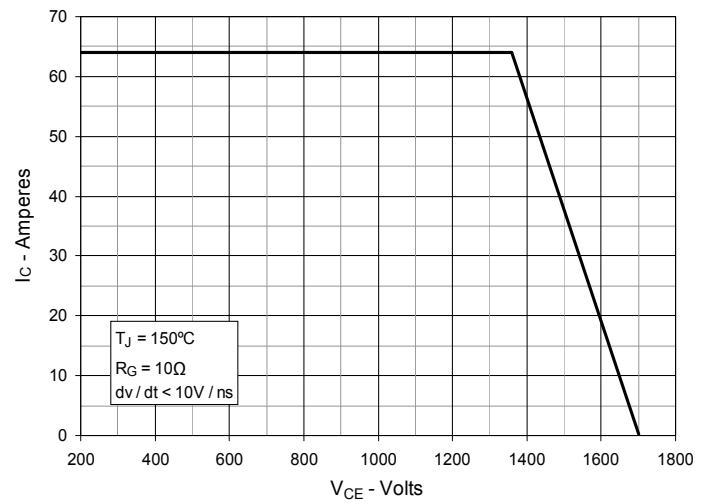
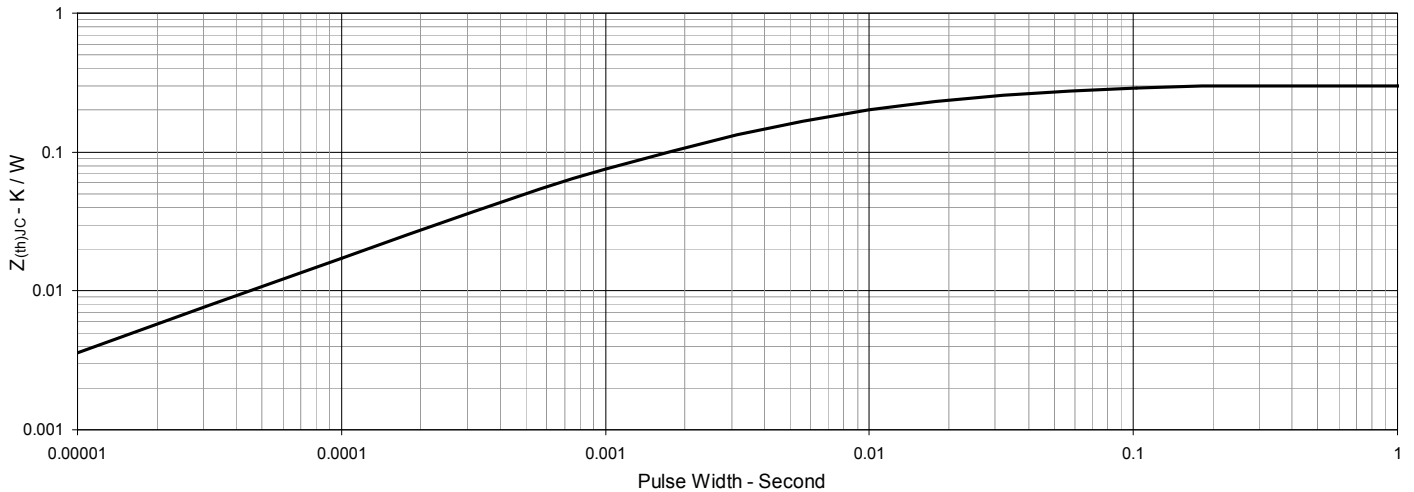


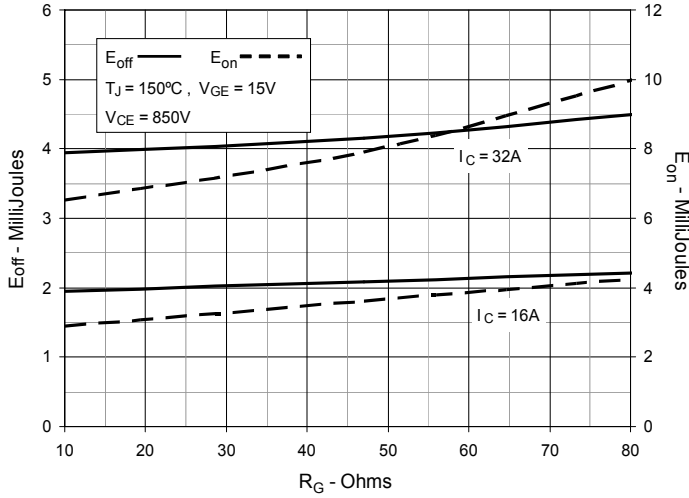
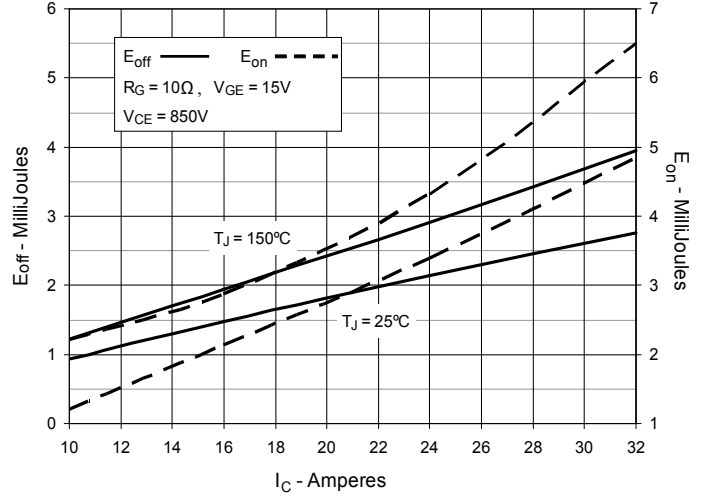
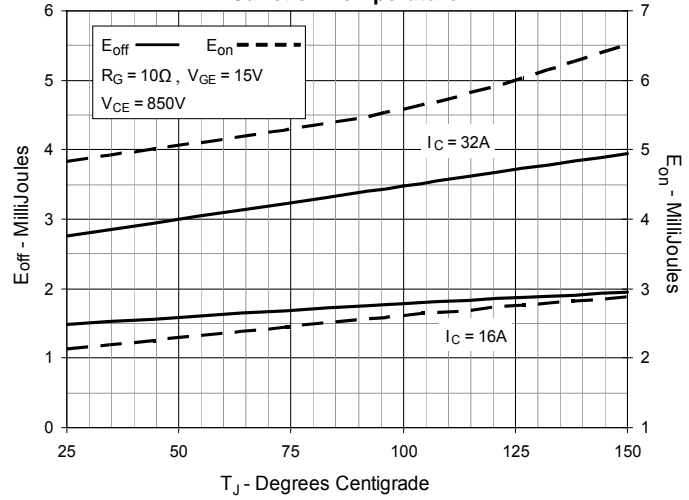
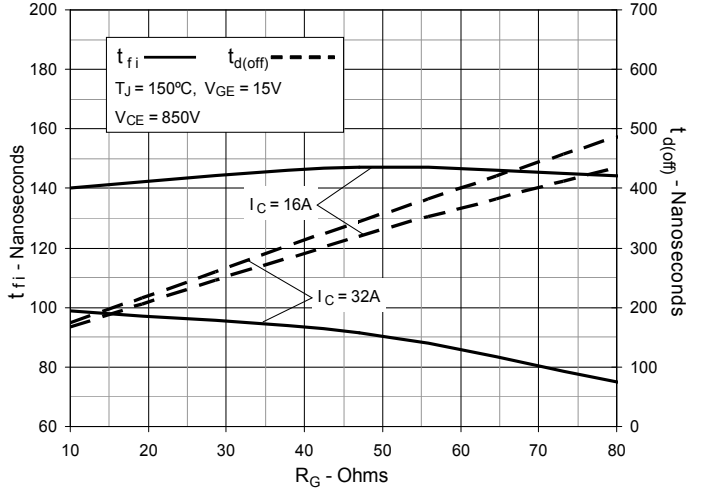
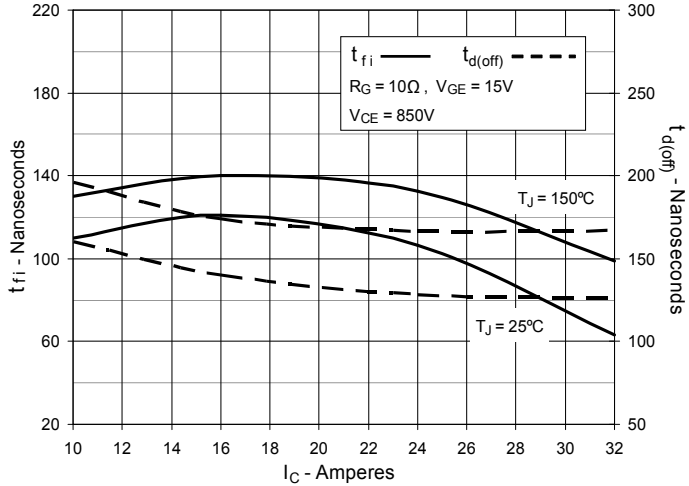
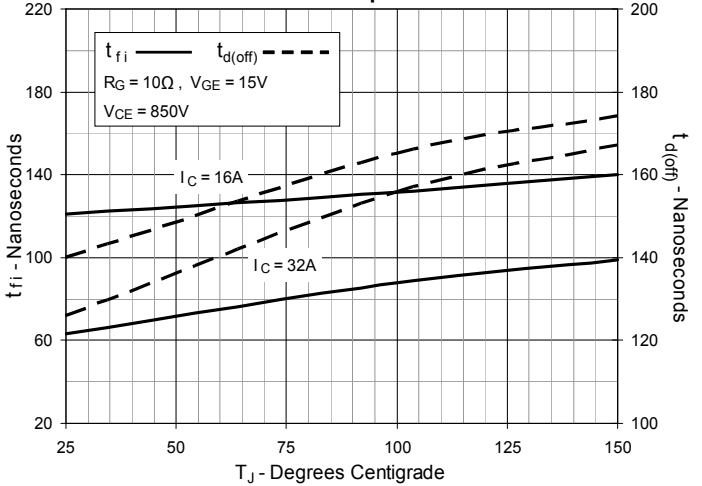
SYM	INCHES		MILLIMETERS	
	MIN	MAX	MIN	MAX
A	.190	.205	4.83	5.21
A1	.090	.100	2.29	2.54
A2	.075	.085	1.91	2.16
b	.045	.055	1.14	1.40
b2	.075	.087	1.91	2.20
b4	.115	.126	2.92	3.20
C	.024	.031	0.61	0.80
D	.819	.840	20.80	21.34
D1	.650	.690	16.51	17.53
D2	.035	.050	0.89	1.27
E	.620	.635	15.75	16.13
E1	.545	.565	13.84	14.35
e	.215 BSC		5.45 BSC	
J	--	.010	--	0.25
K	--	.025	--	0.64
L	.780	.810	19.81	20.57
L1	.150	.170	3.81	4.32
$\phi P$	.140	.144	3.55	3.65
$\phi P1$	.275	.290	6.99	7.37
Q	.220	.244	5.59	6.20
R	.170	.190	4.32	4.83
S	.242 BSC		6.15 BSC	

### IXYS Reserves the Right to Change Limits, Test Conditions, and Dimensions.

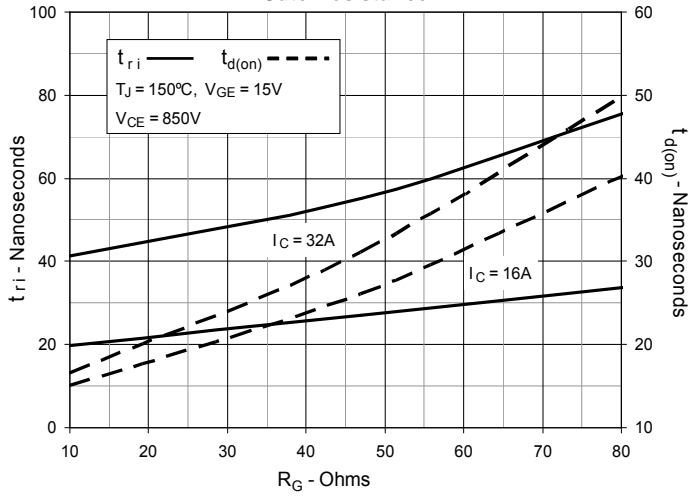
IXYS MOSFETs and IGBTs are covered by one or more of the following U.S. patents:	4,835,592	4,931,844	5,049,961	5,237,481	6,162,665	6,404,065 B1	6,683,344	6,727,585	7,005,734 B2	7,157,338B2
	4,860,072	5,017,508	5,063,307	5,381,025	6,259,123 B1	6,534,343	6,710,405 B2	6,759,692	7,063,975 B2	
	4,881,106	5,034,796	5,187,117	5,486,715	6,306,728 B1	6,583,505	6,710,463	6,771,478 B2	7,071,537	

**Fig. 1. Output Characteristics @  $T_J = 25^\circ\text{C}$** 

**Fig. 2. Extended Output Characteristics @  $T_J = 25^\circ\text{C}$** 

**Fig. 3. Output Characteristics @  $T_J = 150^\circ\text{C}$** 

**Fig. 4. Dependence of  $V_{CE(sat)}$  on Junction Temperature**

**Fig. 5. Collector-to-Emitter Voltage vs. Gate-to-Emitter Voltage**

**Fig. 6. Input Admittance**


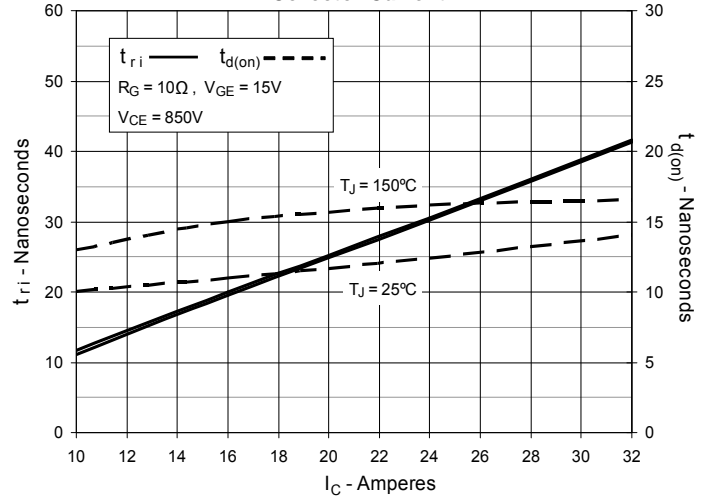
**Fig. 7. Transconductance**

**Fig. 8. Gate Charge**

**Fig. 9. Capacitance**

**Fig. 10. Reverse-Bias Safe Operating Area**

**Fig. 11. Maximum Transient Thermal Impedance (IGBT)**


**Fig. 12. Inductive Switching Energy Loss vs. Gate Resistance**

**Fig. 13. Inductive Switching Energy Loss vs. Collector Current**

**Fig. 14. Inductive Switching Energy Loss vs. Junction Temperature**

**Fig. 15. Inductive Turn-off Switching Times vs. Gate Resistance**

**Fig. 16. Inductive Turn-off Switching Times vs. Collector Current**

**Fig. 17. Inductive Turn-off Switching Times vs. Junction Temperature**


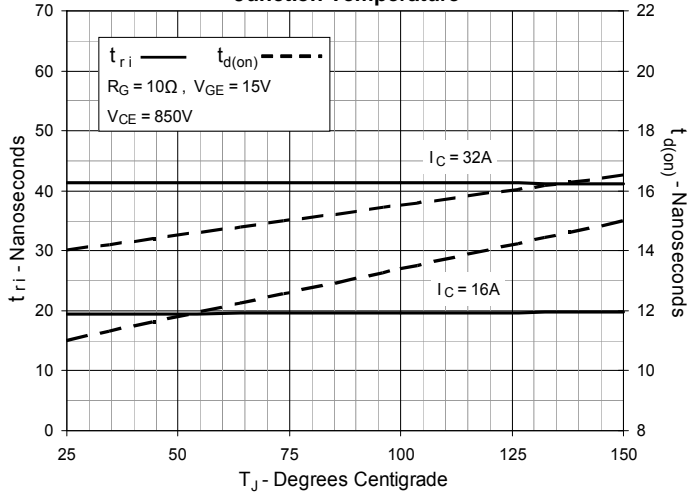
**Fig. 18. Inductive Turn-on Switching Times vs. Gate Resistance**

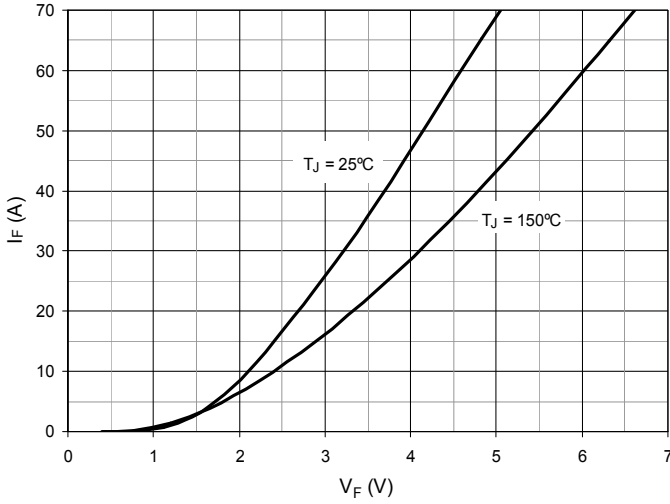
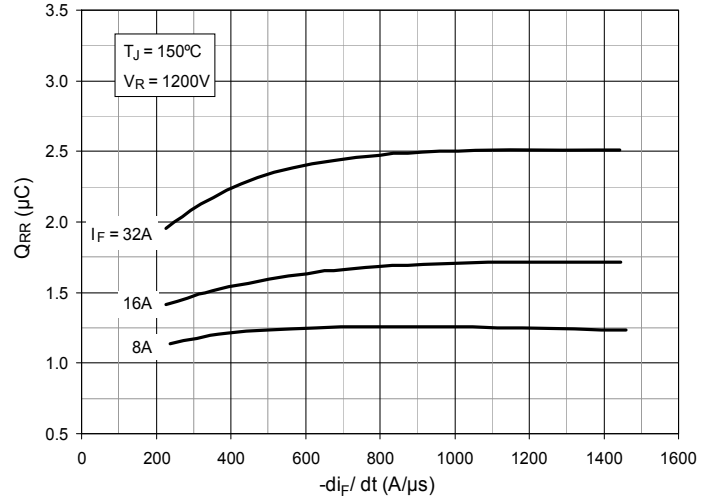
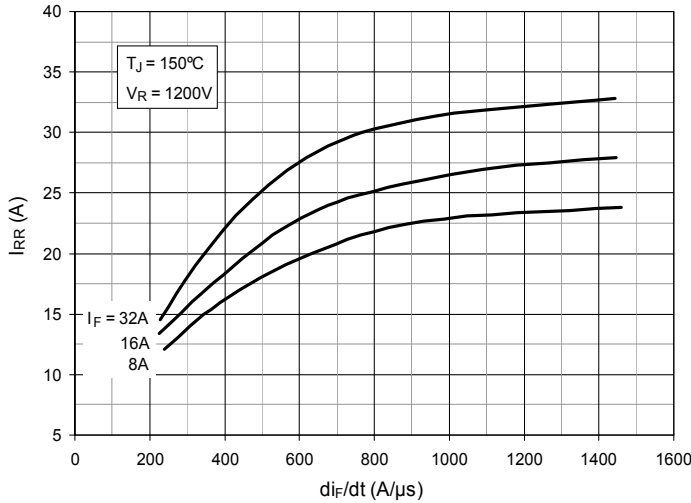
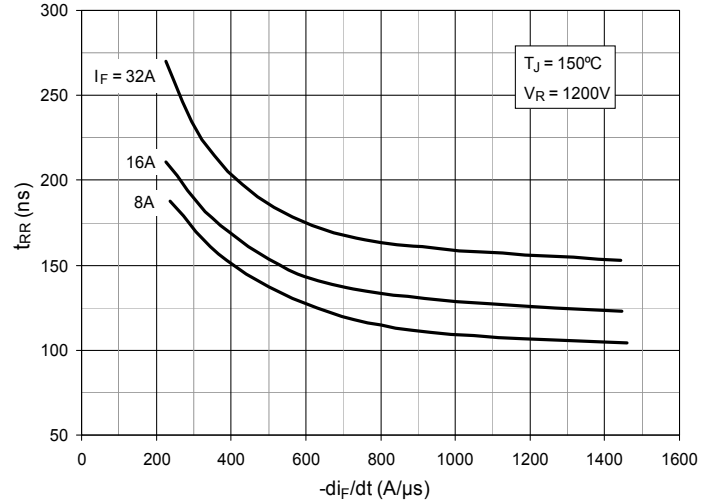
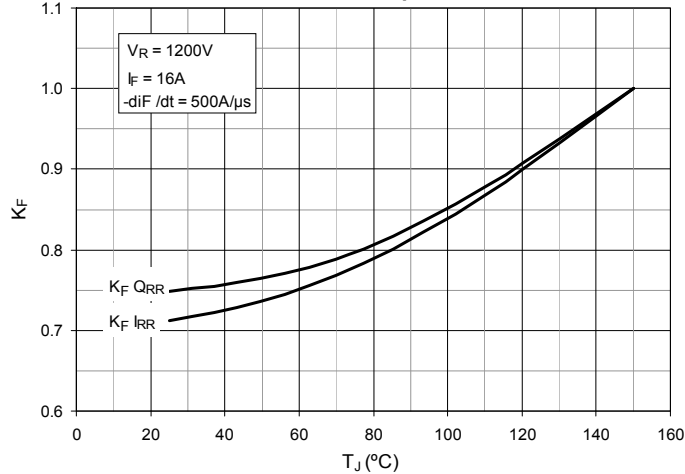
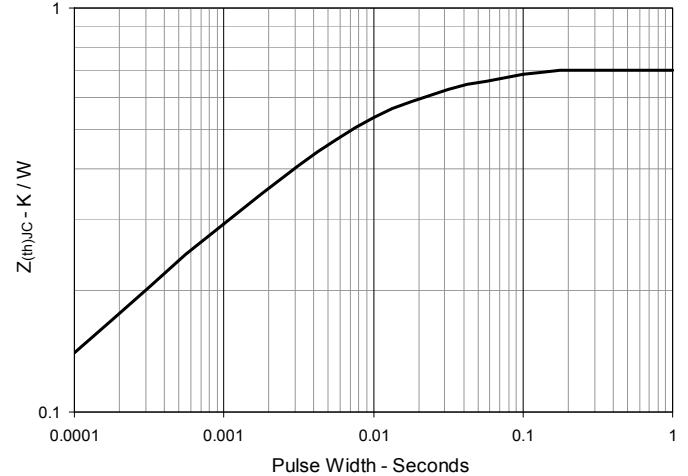


**Fig. 19. Inductive Turn-on Switching Times vs. Collector Current**



**Fig. 20. Inductive Turn-on Switching Times vs. Junction Temperature**



**Fig. 21. Diode Forward Characteristics**

**Fig. 22. Reverse Recovery Charge vs.  $-di_F/dt$** 

**Fig. 23. Reverse Recovery Current vs.  $-di_F/dt$** 

**Fig. 24. Reverse Recovery Time vs.  $-di_F/dt$** 

**Fig. 25. Dynamic Parameters  $Q_{RR}$ ,  $I_{RR}$  vs. Junction Temperature**

**Fig. 26. Maximum Transient Thermal Impedance (Diode)**




---

Disclaimer Notice - Information furnished is believed to be accurate and reliable. However, users should independently evaluate the suitability of and test each product selected for their own applications. Littelfuse products are not designed for, and may not be used in, all applications. Read complete Disclaimer Notice at [www.littelfuse.com/disclaimer-electronics](http://www.littelfuse.com/disclaimer-electronics).