

1200V XPT™ GenX4™ IGBT

IXYA20N120C4HV IXYP20N120C4

High-Speed IGBT
for 20-50 kHz Switching

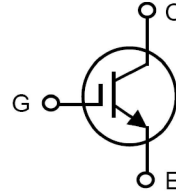

$V_{CES} = 1200V$
 $I_{C110} = 20A$
 $V_{CE(sat)} \leq 2.5V$
 $t_{fi(typ)} = 58ns$

Symbol	Test Conditions	Maximum Ratings	
V_{CES}	$T_J = 25^\circ C$ to $175^\circ C$	1200	V
V_{CGR}	$T_J = 25^\circ C$ to $175^\circ C$, $R_{GE} = 1M\Omega$	1200	V
V_{GES}	Continuous	± 20	V
V_{GEM}	Transient	± 30	V
I_{C25}	$T_C = 25^\circ C$	68	A
I_{C110}	$T_C = 110^\circ C$	20	A
I_{CM}	$T_C = 25^\circ C$, 1ms	120	A
SSOA (RBSOA)	$V_{GE} = 15V$, $T_{VJ} = 150^\circ C$, $R_G = 10\Omega$ Clamped Inductive Load	$I_{CM} = 40$ $V_{CE} \leq 0.8 \cdot V_{CES}$	A
P_C	$T_C = 25^\circ C$	375	W
T_J		-55 ... +175	$^\circ C$
T_{JM}		175	$^\circ C$
T_{stg}		-55 ... +175	$^\circ C$
T_L	Maximum Lead Temperature for Soldering	300	$^\circ C$
T_{SOLD}	1.6 mm (0.062in.) from Case for 10s	260	$^\circ C$
M_d	Mounting Torque (TO-220)	1.13/10	Nm/lb.in
F_C	Mounting Force (TO-263HV)	10..65 / 22..14.6	N/lb
Weight	TO-263HV	2.5	g
	TO-220	3.0	g

TO-263HV
(IXYA..HV)

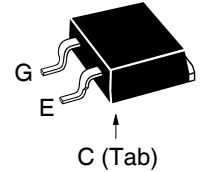

TO-220
(IXYP)

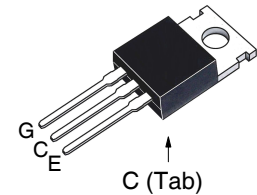

G = Gate D = Collector
E = Emitter Tab = Collector

Features

- Optimized for 20-50kHz Switching
- Positive Thermal Coefficient of $V_{ce(sat)}$
- International Standard Packages

Advantages

- High Power Density
- Low Gate Drive Requirement

Applications

- Power Inverters
- UPS
- Motor Drives
- SMPS
- Battery Chargers
- Welding Machines
- Lamp Ballasts

Symbol	Test Conditions ($T_J = 25^\circ C$, Unless Otherwise Specified)	Characteristic Values		
		Min.	Typ.	Max.
BV_{CES}	$I_C = 250\mu A$, $V_{GE} = 0V$	1200		V
$V_{GE(th)}$	$I_C = 250\mu A$, $V_{CE} = V_{GE}$	4.0		6.5 V
I_{CES}	$V_{CE} = V_{CES}$, $V_{GE} = 0V$ $T_J = 150^\circ C$			25 μA 5 mA
I_{GES}	$V_{CE} = 0V$, $V_{GE} = \pm 20V$			± 100 nA
$V_{CE(sat)}$	$I_C = 20A$, $V_{GE} = 15V$, Note 1 $T_J = 150^\circ C$		2.1 2.5	V V

Symbol Test Conditions ($T_J = 25^\circ\text{C}$ Unless Otherwise Specified)		Characteristic Values		
		Min.	Typ.	Max.
g_{fs}	$I_C = 20\text{A}, V_{CE} = 10\text{V}$, Note 1	7.5	12.5	S
C_{ies}	$V_{CE} = 25\text{V}, V_{GE} = 0\text{V}, f = 1\text{MHz}$		890	pF
C_{oes}			95	pF
C_{res}			33	pF
$Q_{g(on)}$	$I_C = 20\text{A}, V_{GE} = 15\text{V}, V_{CE} = 0.5 \cdot V_{CES}$		44	nC
Q_{ge}			8	nC
Q_{gc}			20	nC
$t_{d(on)}$	Inductive load, $T_J = 25^\circ\text{C}$ $I_C = 20\text{A}, V_{GE} = 15\text{V}$ $V_{CE} = 0.8 \cdot V_{CES}, R_G = 10\Omega$ Note 2		14	ns
t_{ri}			53	ns
E_{on}			4.4	mJ
$t_{d(off)}$			160	ns
t_{fi}			58	ns
E_{off}			1.0	mJ
$t_{d(on)}$	Inductive load, $T_J = 125^\circ\text{C}$ $I_C = 20\text{A}, V_{GE} = 15\text{V}$ $V_{CE} = 0.8 \cdot V_{CES}, R_G = 10\Omega$ Note 2		13	ns
t_{ri}			37	ns
E_{on}			4.9	mJ
$t_{d(off)}$			200	ns
t_{fi}			86	ns
E_{off}			1.6	mJ
R_{thJC}	TO-220			0.40 $^\circ\text{C/W}$
R_{thCS}		0.50		$^\circ\text{C/W}$

Notes:

1. Pulse test, $t \leq 300\mu\text{s}$, duty cycle, $d \leq 2\%$.
2. Switching times & energy losses may increase for higher V_{CE} (clamp), T_J or R_G .

IXYS Reserves the Right to Change Limits, Test Conditions, and Dimensions.

IXYS MOSFETs and IGBTs are covered	4,835,592	4,931,844	5,049,961	5,237,481	6,162,665	6,404,065 B1	6,683,344	6,727,585	7,005,734 B2	7,157,338B2
by one or more of the following U.S. patents:	4,860,072	5,017,508	5,063,307	5,381,025	6,259,123 B1	6,534,343	6,710,405 B2	6,759,692	7,063,975 B2	
	4,881,106	5,034,796	5,187,117	5,486,715	6,306,728 B1	6,583,505	6,710,463	6,771,478 B2	7,071,537	

Fig. 1. Output Characteristics @ $T_J = 25^\circ\text{C}$

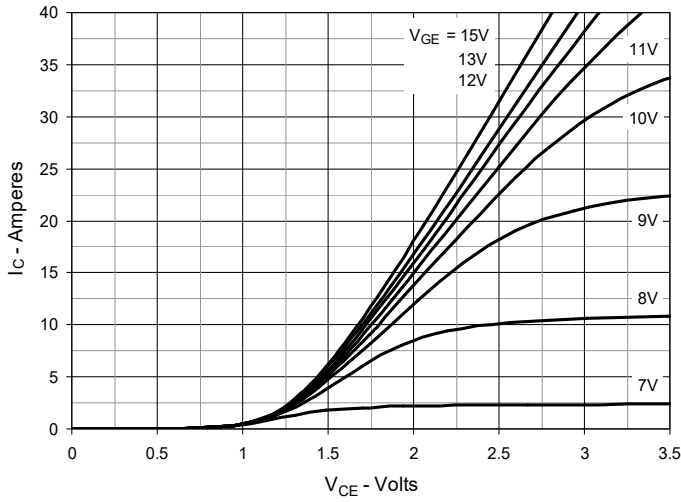

Fig. 2. Extended Output Characteristics @ $T_J = 25^\circ\text{C}$

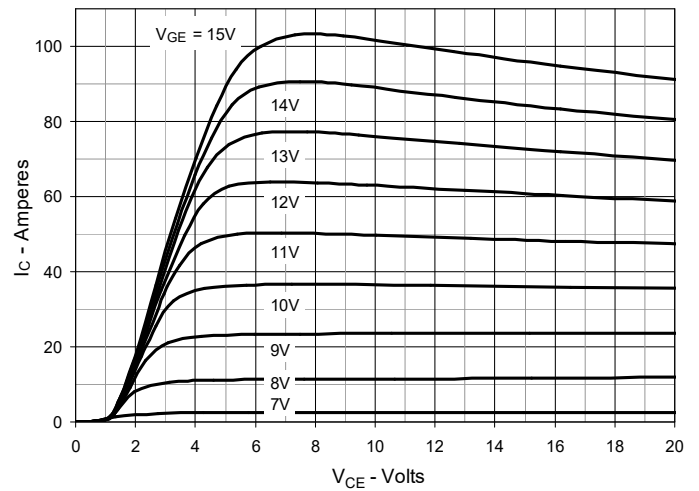

Fig. 3. Output Characteristics @ $T_J = 150^\circ\text{C}$

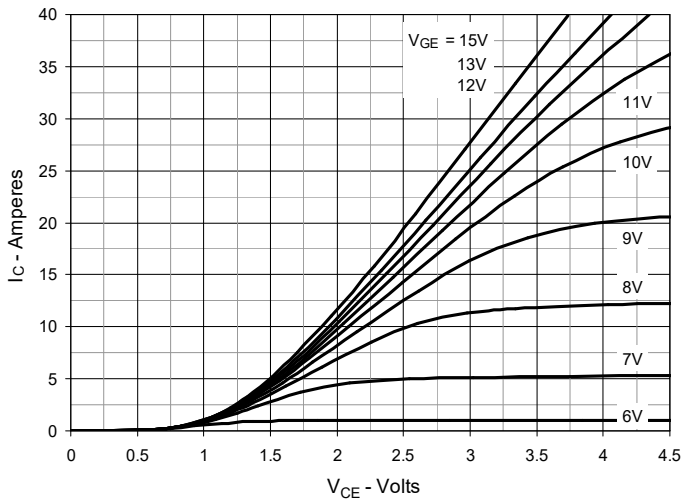

Fig. 4. Dependence of $V_{CE(sat)}$ on Junction Temperature

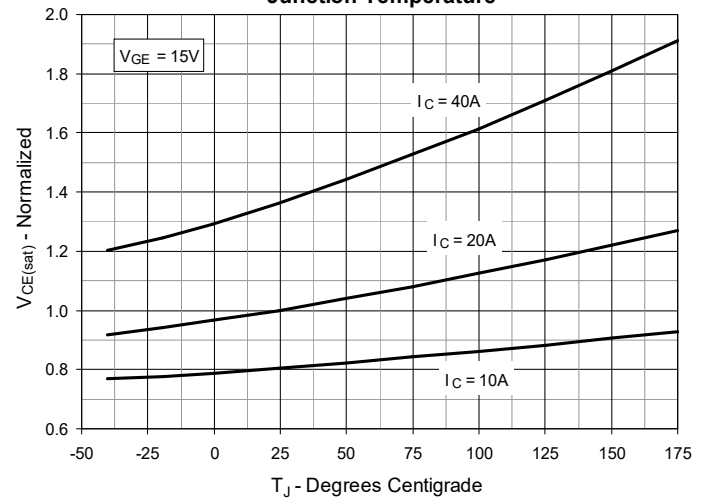

Fig. 5. Collector-to-Emitter Voltage vs. Gate-to-Emitter Voltage

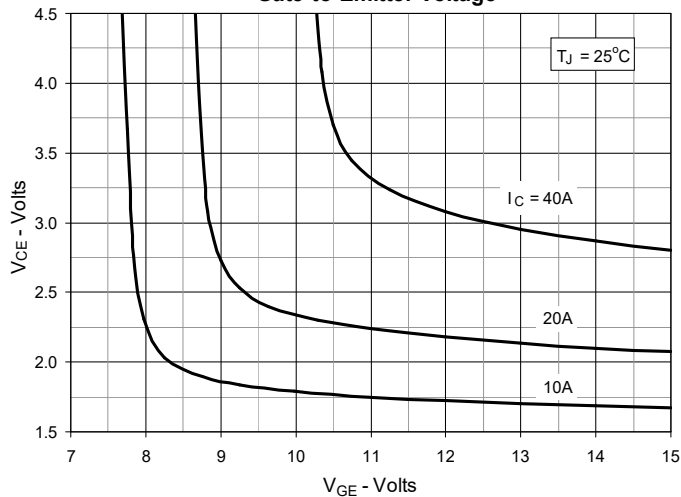

Fig. 6. Input Admittance

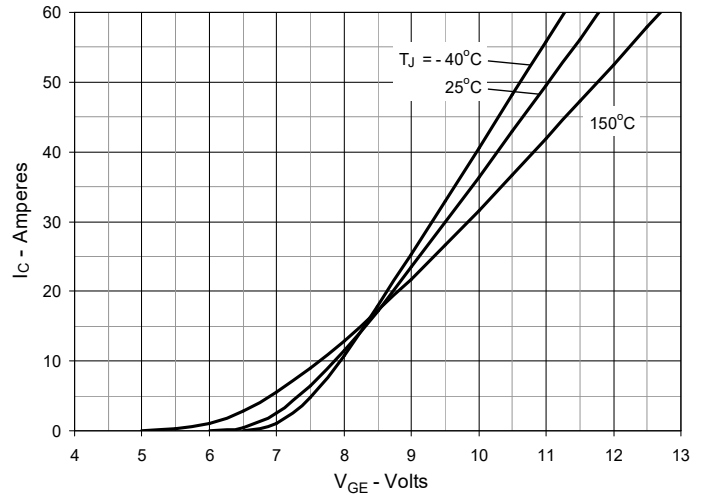

Fig. 7. Transconductance

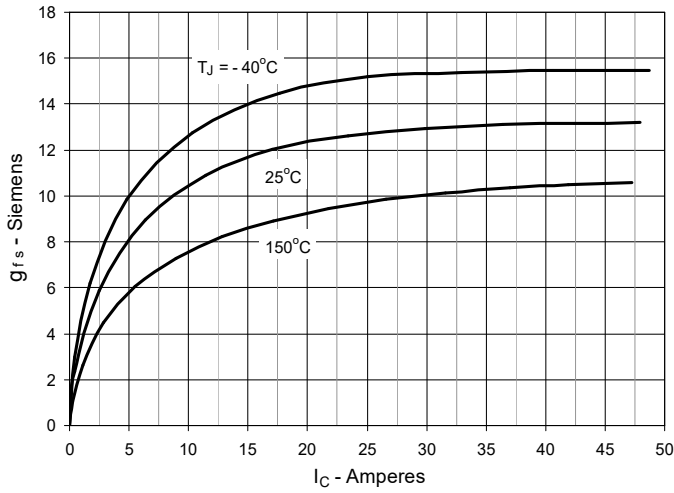

Fig. 8. Gate Charge

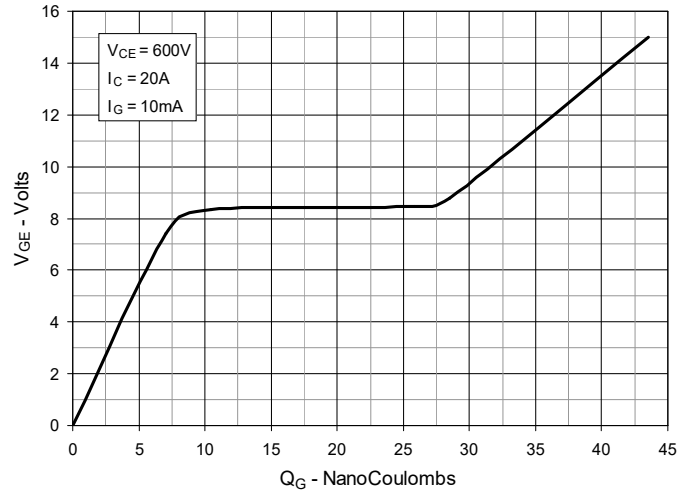

Fig. 9. Capacitance

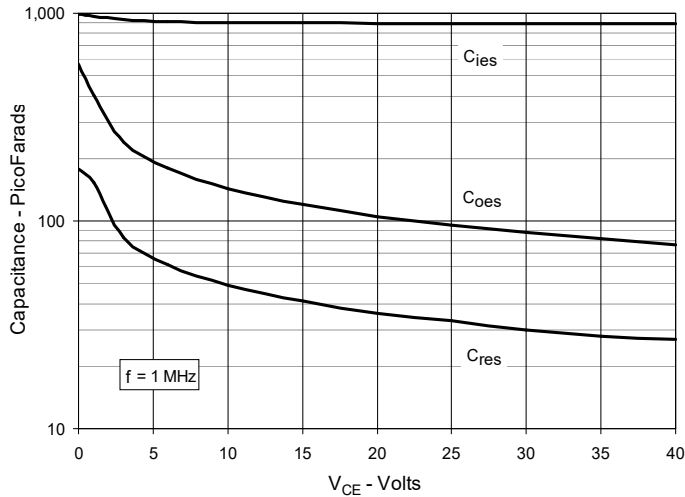

Fig. 10. Reverse-Bias Safe Operating Area

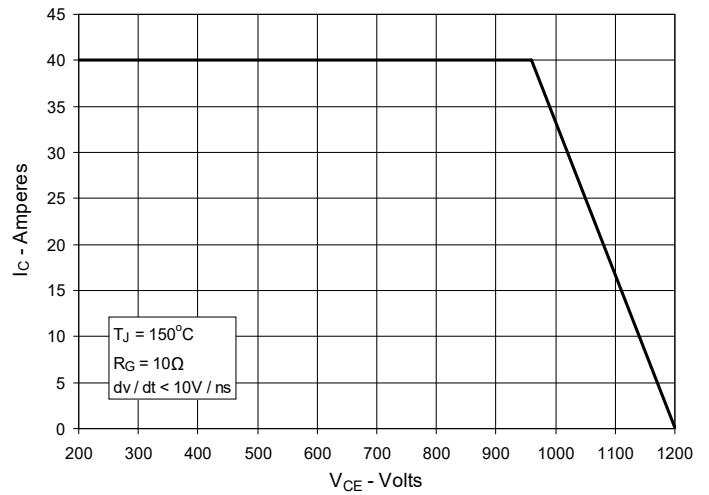

Fig. 11. Maximum Transient Thermal Impedance

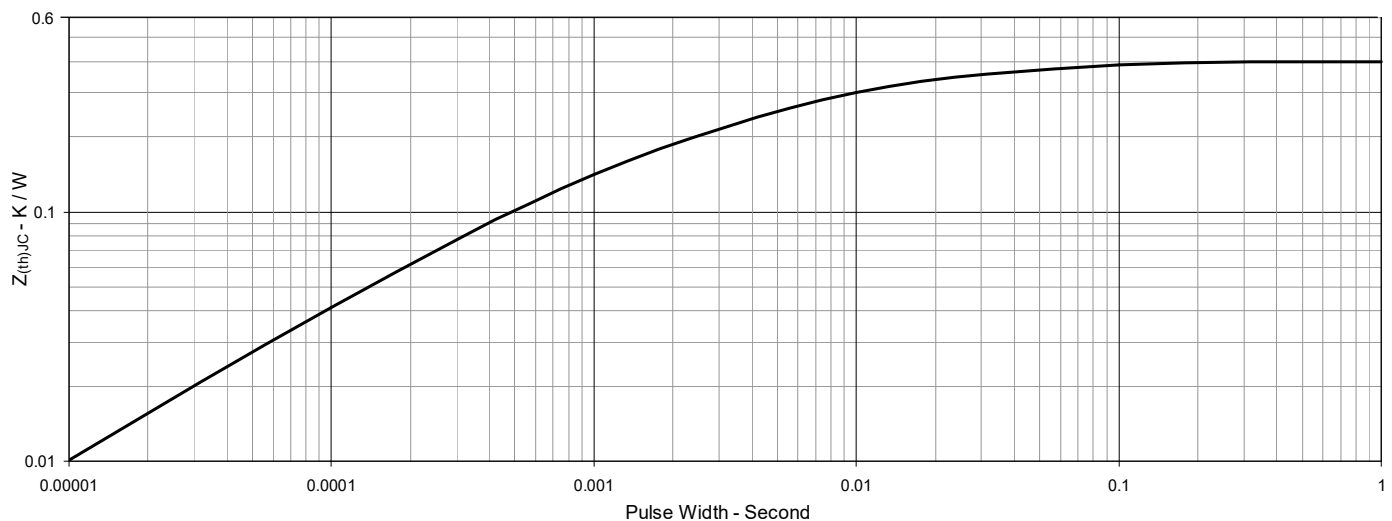

Fig. 12. Inductive Switching Energy Loss vs. Gate Resistance

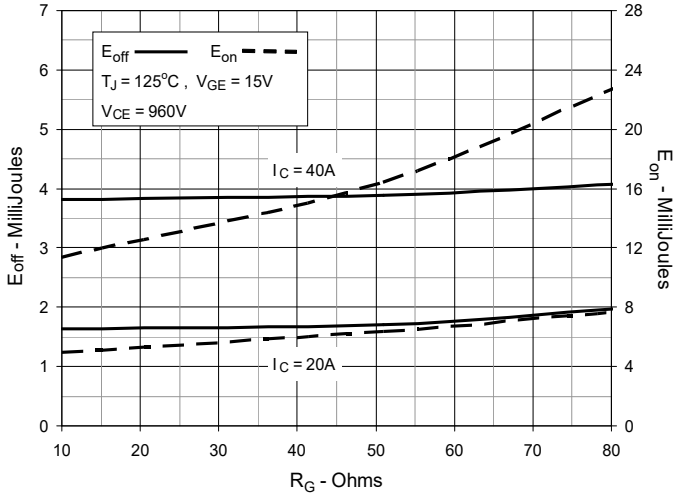

Fig. 13. Inductive Switching Energy Loss vs. Collector Current

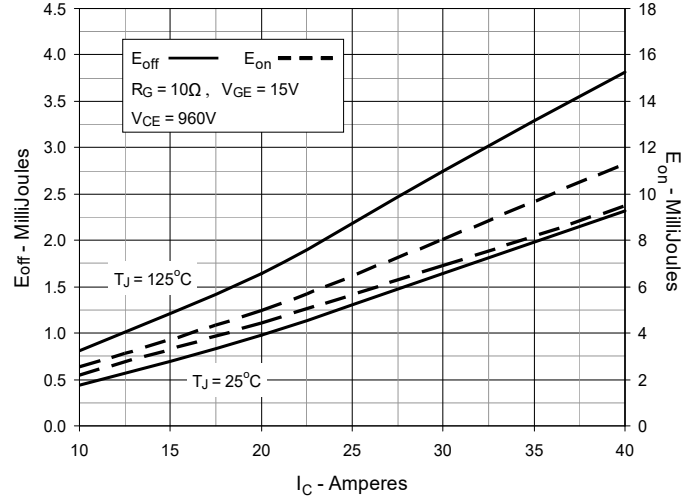

Fig. 14. Inductive Switching Energy Loss vs. Junction Temperature

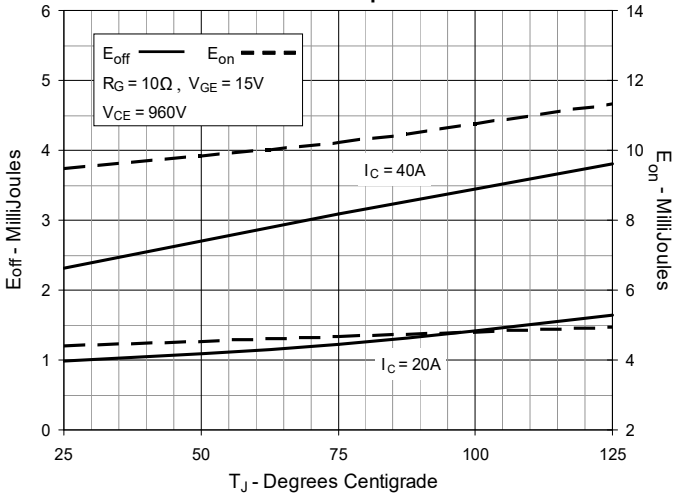

Fig. 15. Inductive Turn-off Switching Times vs. Gate Resistance

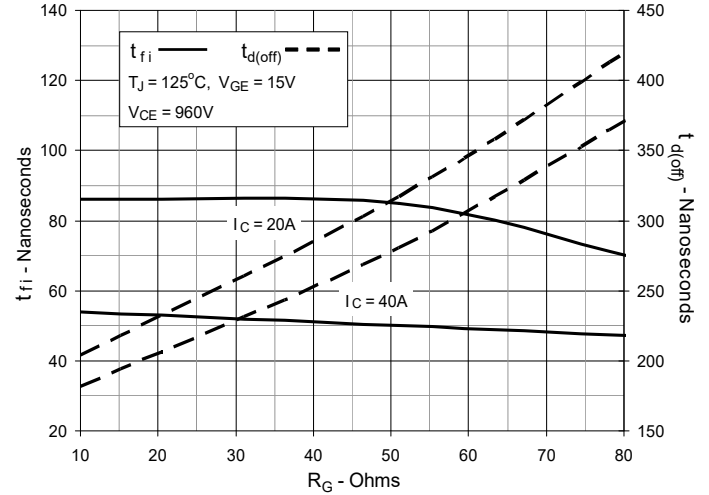

Fig. 16. Inductive Turn-off Switching Times vs. Collector Current

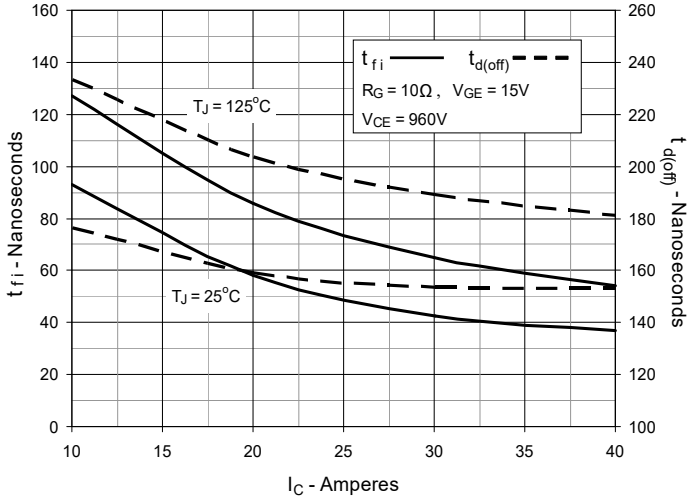

Fig. 17. Inductive Turn-off Switching Times vs. Junction Temperature

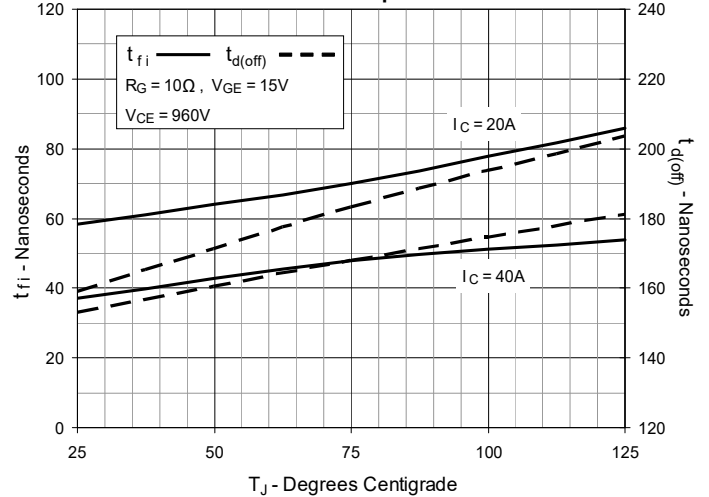

Fig. 18. Inductive Turn-on Switching Times vs. Gate Resistance

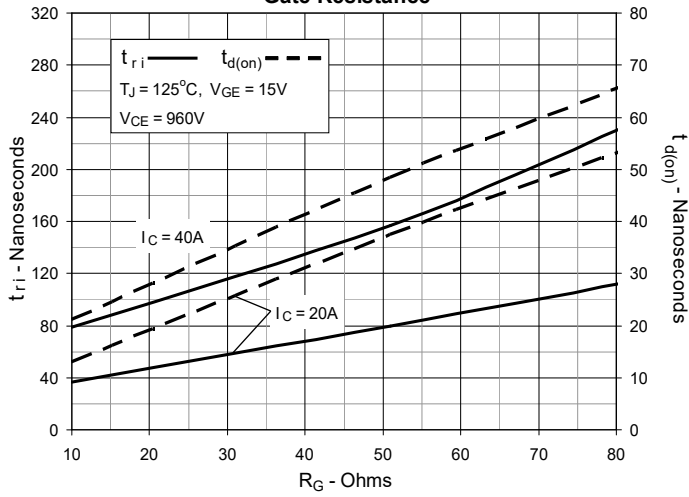

Fig. 19. Inductive Turn-on Switching Times vs. Collector Current

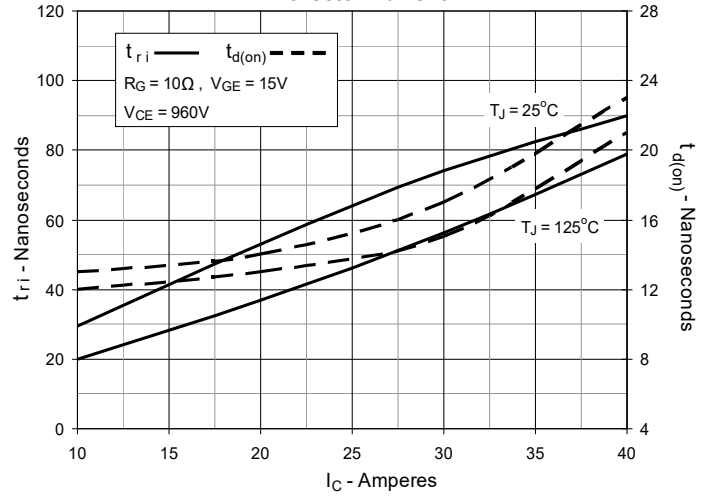
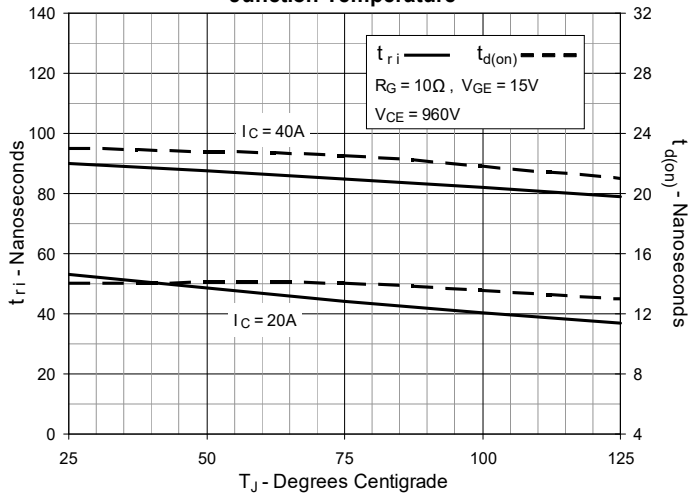
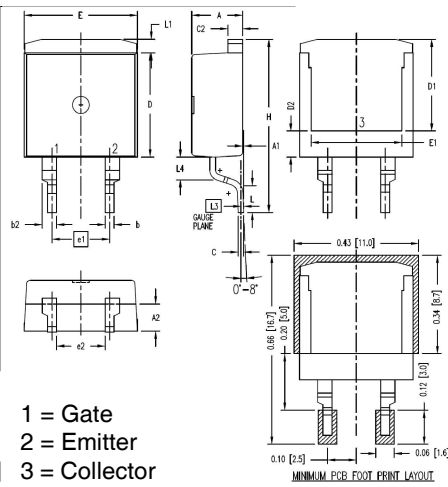

Fig. 20. Inductive Turn-on Switching Times vs. Junction Temperature



TO-263HV Outline



SYM	INCHES		MILLIMETER	
	MIN	MAX	MIN	MAX
A	.170	.185	4.30	4.70
A1	.000	.008	0.00	0.20
A2	.091	.098	2.30	2.50
b	.028	.035	0.70	0.90
b2	.046	.054	1.18	1.38
C	.018	.024	0.45	0.60
C2	.049	.055	1.25	1.40
D	.354	.370	9.00	9.40
D1	.311	.327	7.90	8.30
D2	.083	.098	2.10	2.50
E	.386	.402	9.80	10.20
E1	.307	.323	7.80	8.20
e1	.200 BSC		5.08 BSC	
(e2)	.163	.174	4.13	4.43
H	.591	.614	15.00	15.60
L	.079	.102	2.00	2.60
L1	.039	.055	1.00	1.40
L3	.010 BSC		0.254 BSC	
(L4)	.071	.087	1.80	2.20

TO-220 Outline

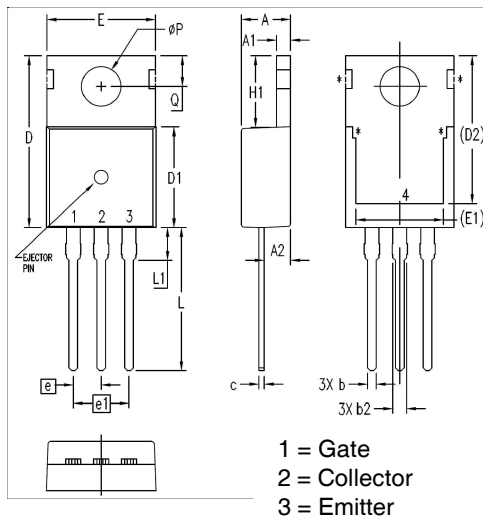

SYM	INCHES		MILLIMETERS	
	MIN	MAX	MIN	MAX
A	.169	.185	4.30	4.70
A1	.047	.055	1.20	1.40
A2	.079	.106	2.00	2.70
b	.024	.039	0.60	1.00
b2	.045	.057	1.15	1.45
c	.014	.026	0.35	0.65
D	.587	.626	14.90	15.90
D1	.335	.370	8.50	9.40
(D2)	.500	.531	12.70	13.50
E	.382	.406	9.70	10.30
(E1)	.283	.323	7.20	8.20
e	.100 BSC		2.54 BSC	
e1	.200 BSC		5.08 BSC	
H1	.244	.268	6.20	6.80
L	.492	.547	12.50	13.90
L1	.110	.154	2.80	3.90
ØP	.134	.150	3.40	3.80
Q	.106	.126	2.70	3.20



Disclaimer Notice - Information furnished is believed to be accurate and reliable. However, users should independently evaluate the suitability of and test each product selected for their own applications. Littelfuse products are not designed for, and may not be used in, all applications. Read complete Disclaimer Notice at www.littelfuse.com/disclaimer-electronics.

IXYS Reserves the Right to Change Limits, Test Conditions, and Dimensions.
