

# XPT™ 650V IGBT GenX4™

# IXXN340N65B4

Extreme Light Punch Through  
IGBT for 10-30kHz Switching

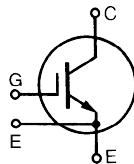

$V_{CES} = 650V$   
 $I_{C90} = 340A$   
 $V_{CE(sat)} \leq 1.7V$   
 $t_{fi}(typ) = 80ns$

Symbol	Test Conditions	Maximum Ratings	
$V_{CES}$	$T_J = 25^\circ C$ to $175^\circ C$	650	V
$V_{CGR}$	$T_J = 25^\circ C$ to $175^\circ C$ , $R_{GE} = 1M\Omega$	650	V
$V_{GES}$	Continuous	$\pm 20$	V
$V_{GEM}$	Transient	$\pm 30$	V
$I_{C25}$	$T_C = 25^\circ C$ (Chip Capability)	520	A
$I_{LRMS}$	Leads Current Limit	200	A
$I_{C90}$	$T_C = 90^\circ C$	340	A
$I_{CM}$	$T_C = 25^\circ C$ , 1ms	1200	A
<b>SSOA</b>	$V_{GEC} = 15V$ , $T_{VJ} = 150^\circ C$ , $R_G = 1\Omega$	$I_{CM} = 400$	A
<b>(RBSOA)</b>	Clamped Inductive Load	@ $V_{CE} \leq V_{CES}$	
$t_{sc}$	$V_{GE} = 15V$ , $V_{CE} = 360V$ , $T_J = 150^\circ C$	10	$\mu s$
<b>(SCSOA)</b>	$R_G = 10\Omega$ , Non Repetitive		
$P_C$	$T_C = 25^\circ C$	1500	W
$T_J$		-55 ... +175	$^\circ C$
$T_{JM}$		175	$^\circ C$
$T_{stg}$		-55 ... +175	$^\circ C$
$V_{ISOL}$	50/60Hz	$t = 1min$	V~
	$I_{ISOL} \leq 1mA$	$t = 1s$	V~
$M_d$	Mounting Torque	1.5/13	Nm/lb.in.
	Terminal Connection Torque	1.3/11.5	Nm/lb.in.
<b>Weight</b>		30	g

SOT-227B, miniBLOC

E153432

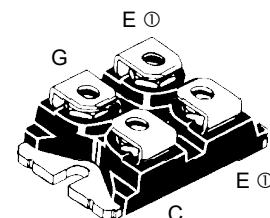

G = Gate, C = Collector, E = Emitter  
 Ⓣ either emitter terminal can be used as Main or Kelvin Emitter

### Features

- Optimized for Low Conduction and Switching Losses
- miniBLOC, with Aluminium Nitride Isolation
- International Standard Package
- Isolation Voltage 2500V~
- Optimized for 10-30kHz Switching
- Square RBSOA
- Short Circuit Capability
- High Current Handling Capability

### Advantages

- High Power Density
- Low Gate Drive Requirement

### Applications

- Power Inverters
- UPS
- Motor Drives
- SMPS
- PFC Circuits
- Battery Chargers
- Welding Machines
- Lamp Ballasts

Symbol	Test Conditions ( $T_J = 25^\circ C$ , Unless Otherwise Specified)	Characteristic Values		
		Min.	Typ.	Max.
$BV_{CES}$	$I_C = 250\mu A$ , $V_{GE} = 0V$	650		V
$V_{GE(th)}$	$I_C = 4mA$ , $V_{CE} = V_{GE}$	4.0		6.5 V
$I_{CES}$	$V_{CE} = V_{CES}$ , $V_{GE} = 0V$ $T_J = 150^\circ C$			25 $\mu A$
				2 mA
$I_{GES}$	$V_{CE} = 0V$ , $V_{GE} = \pm 20V$			$\pm 200$ nA
$V_{CE(sat)}$	$I_C = 160A$ , $V_{GE} = 15V$ , Note 1 $T_J = 150^\circ C$		1.4	1.7 V
			1.4	V

Symbol Test Conditions ( $T_J = 25^\circ\text{C}$ Unless Otherwise Specified)	Characteristic Values		
	Min.	Typ.	Max.
$g_{fs}$ $I_C = 60\text{A}, V_{CE} = 10\text{V}, \text{Note 1}$	50	85	S
$C_{ies}$ $C_{oes}$ $C_{res}$	$V_{CE} = 25\text{V}, V_{GE} = 0\text{V}, f = 1\text{MHz}$	11.25	nF
		670	pF
		390	pF
$Q_{g(on)}$ $Q_{ge}$ $Q_{gc}$	$I_C = 200\text{A}, V_{GE} = 15\text{V}, V_{CE} = 0.5 \cdot V_{CES}$	553	nC
		110	nC
		253	nC
$t_{d(on)}$ $t_{ri}$ $E_{on}$ $t_{d(off)}$ $t_{fi}$ $E_{off}$	<b>Inductive load, <math>T_J = 25^\circ\text{C}</math></b> $I_C = 100\text{A}, V_{GE} = 15\text{V}$ $V_{CE} = 400\text{V}, R_G = 1\Omega$ Note 2	62	ns
		76	ns
		4.40	mJ
		245	ns
		80	ns
		2.20	3.50 mJ
$t_{d(on)}$ $t_{ri}$ $E_{on}$ $t_{d(off)}$ $t_{fi}$ $E_{off}$	<b>Inductive load, <math>T_J = 150^\circ\text{C}</math></b> $I_C = 100\text{A}, V_{GE} = 15\text{V}$ $V_{CE} = 400\text{V}, R_G = 1\Omega$ Note 2	54	ns
		65	ns
		5.55	mJ
		236	ns
		110	ns
		2.54	mJ
$R_{thJC}$			0.10 $^\circ\text{C/W}$
$R_{thCS}$	0.05		$^\circ\text{C/W}$

**Notes:**

1. Pulse test,  $t \leq 300\mu\text{s}$ , duty cycle,  $d \leq 2\%$ .
2. Switching times & energy losses may increase for higher  $V_{CE}(\text{clamp})$ ,  $T_J$  or  $R_G$ .

Littelfuse reserves the right to change limits, test conditions, and dimensions.

IXYS MOSFETs and IGBTs are covered	4,835,592	4,931,844	5,049,961	5,237,481	6,162,665	6,404,065 B1	6,683,344	6,727,585	7,005,734 B2	7,157,338B2
by one or more of the following U.S. patents:	4,860,072	5,017,508	5,063,307	5,381,025	6,259,123 B1	6,534,343	6,710,405 B2	6,759,692	7,063,975 B2	
	4,881,106	5,034,796	5,187,117	5,486,715	6,306,728 B1	6,583,505	6,710,463	6,771,478 B2	7,071,537	

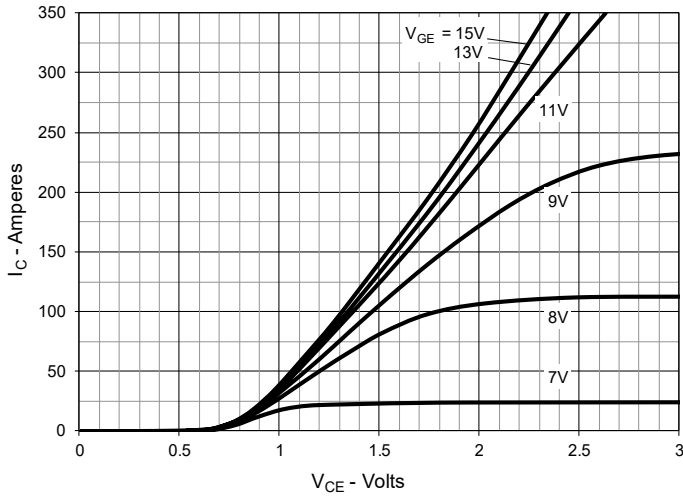
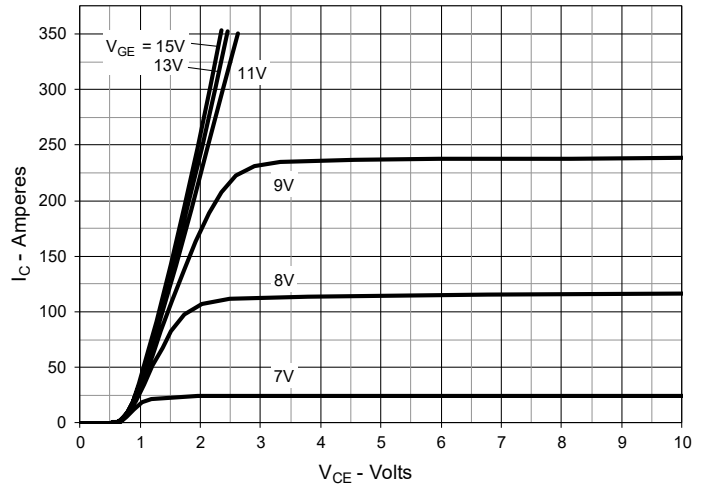
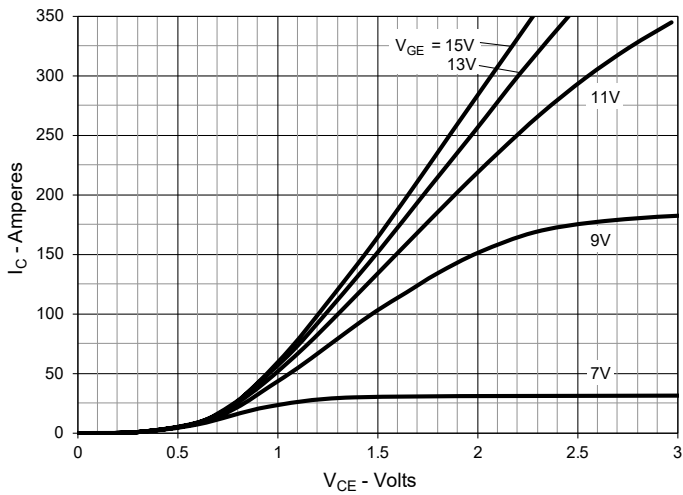
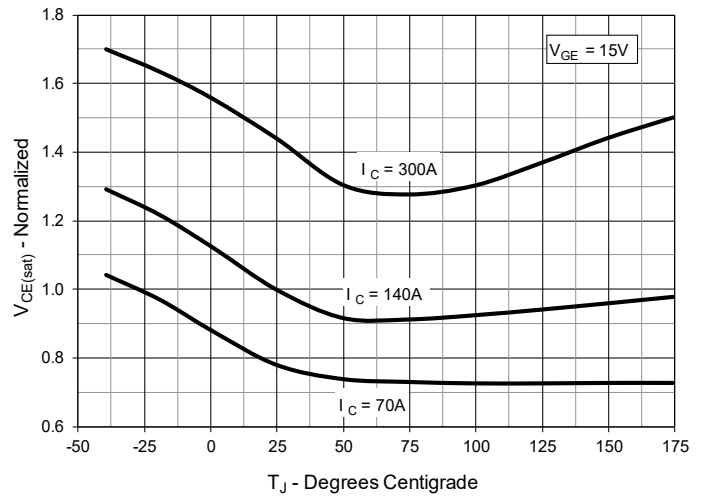
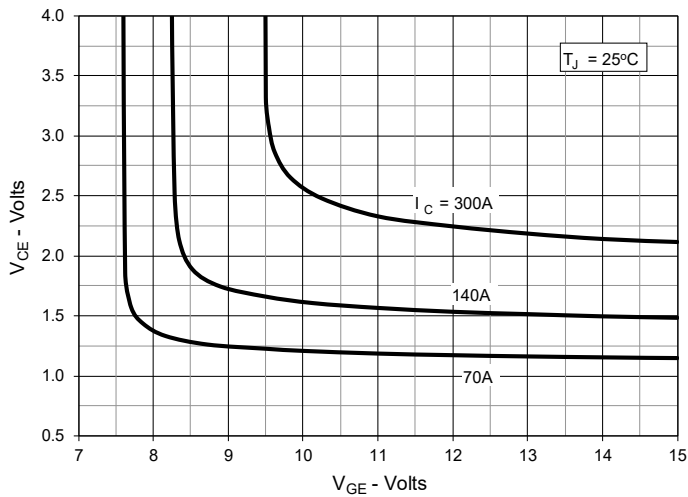
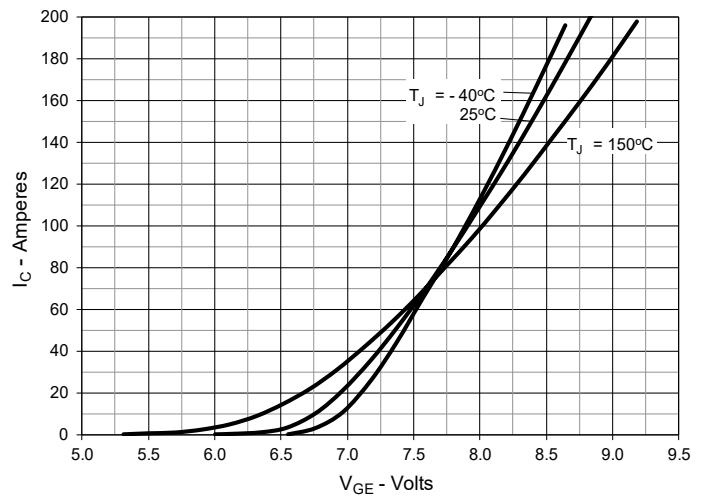
**Fig. 1. Output Characteristics @  $T_J = 25^\circ\text{C}$** 

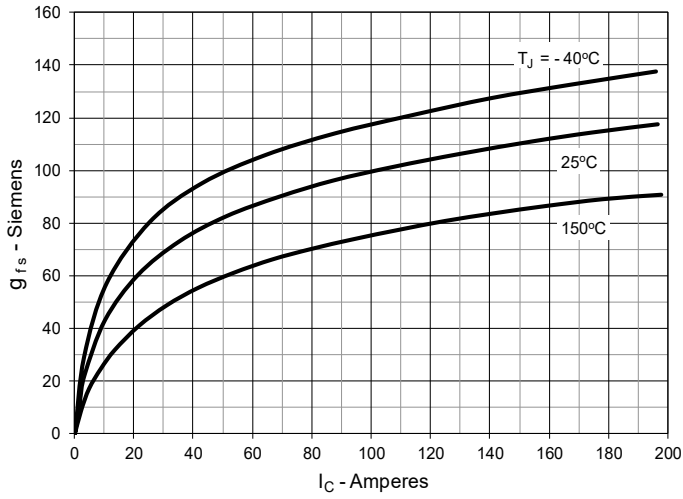
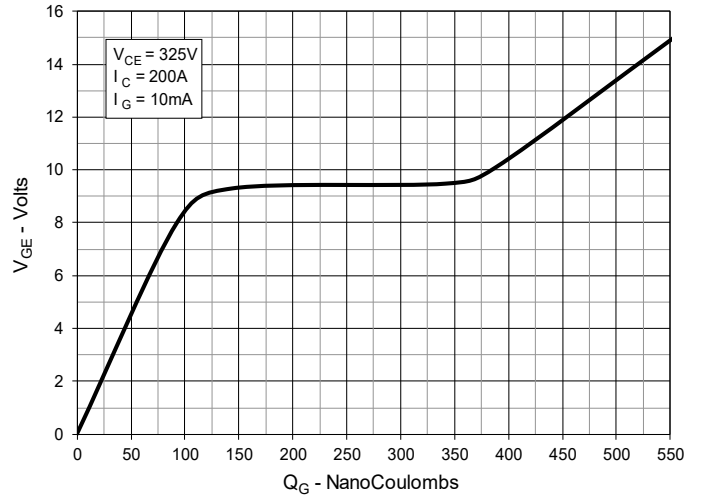
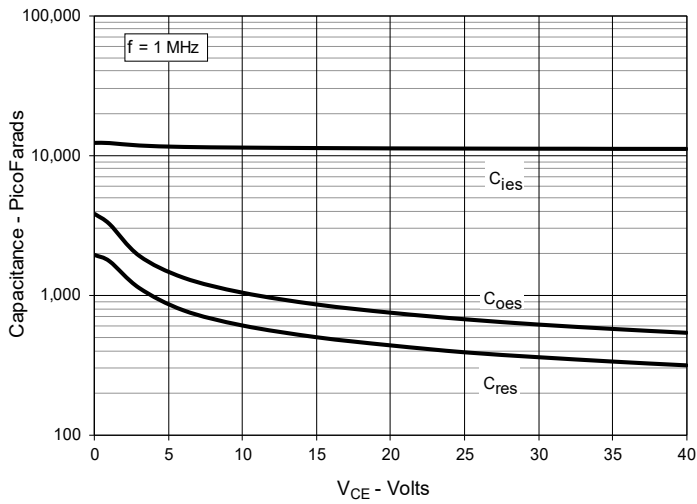
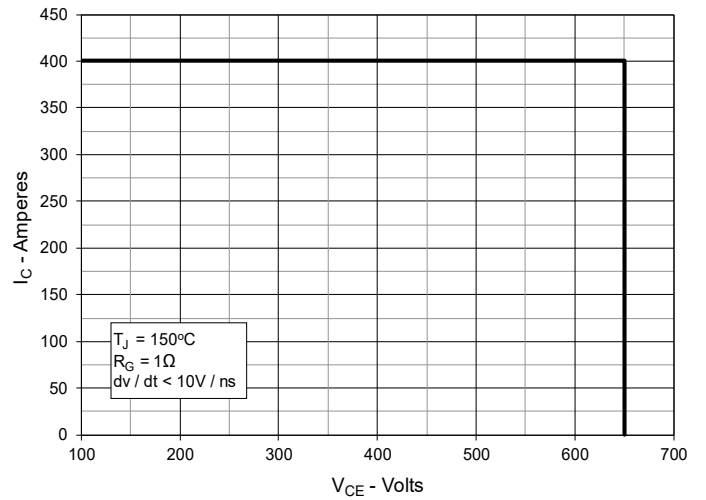
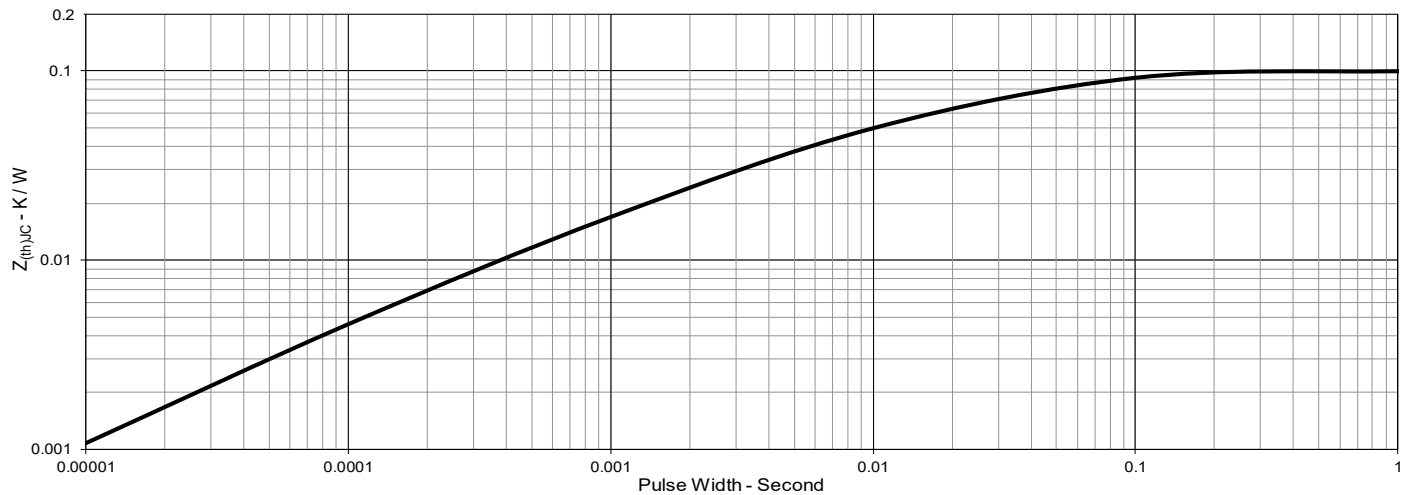
**Fig. 2. Extended Output Characteristics @  $T_J = 25^\circ\text{C}$** 

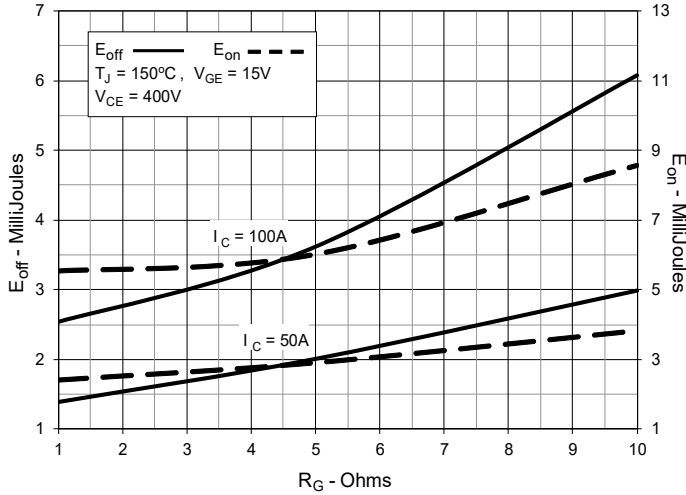
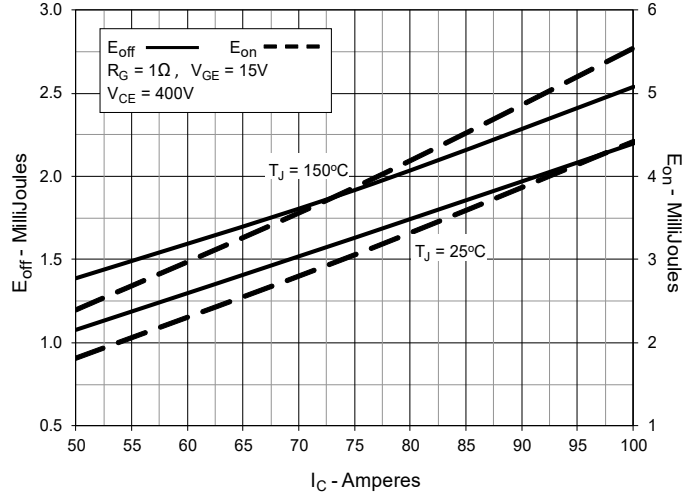
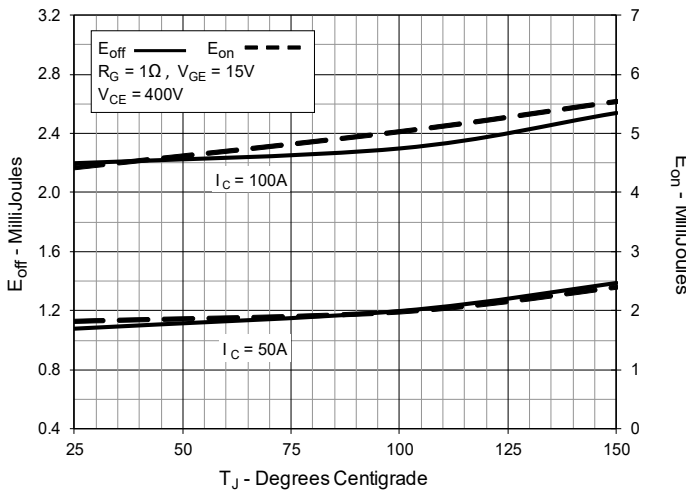
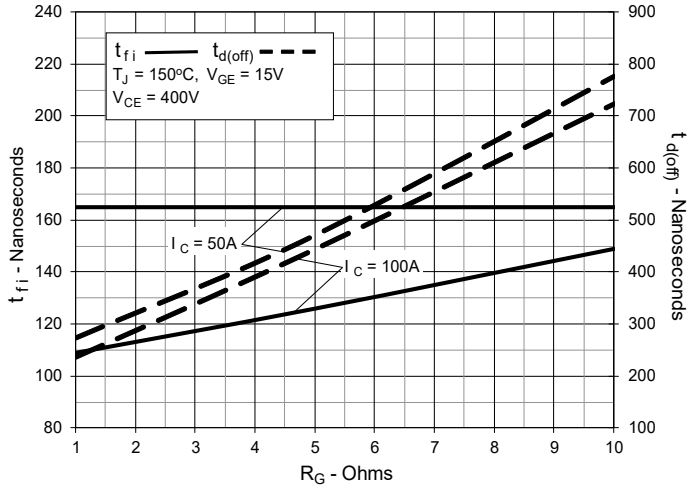
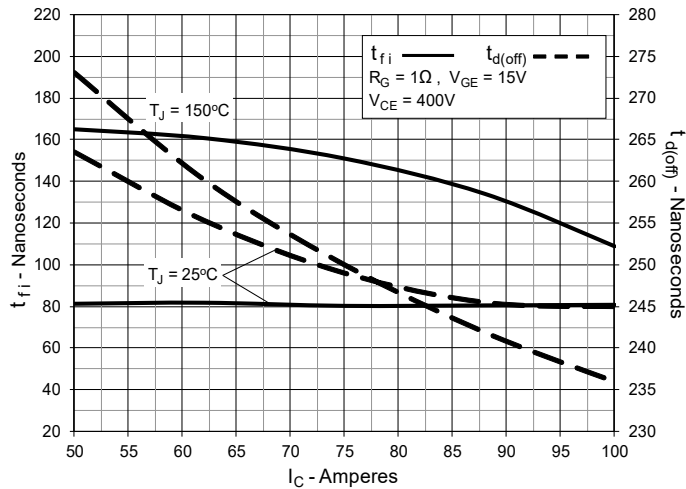
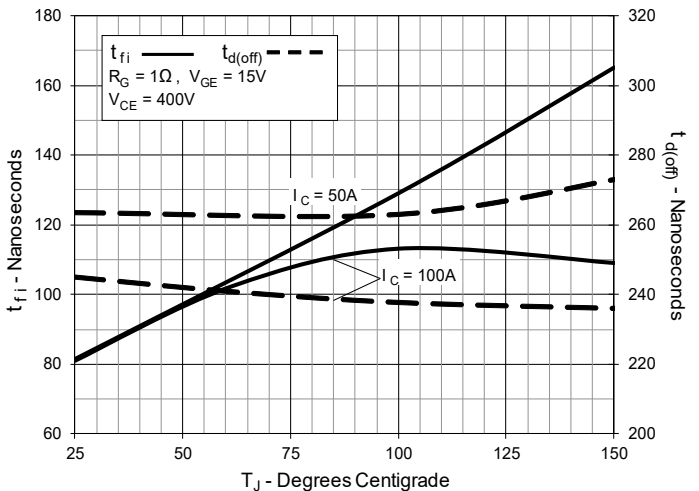
**Fig. 3. Output Characteristics @  $T_J = 150^\circ\text{C}$** 

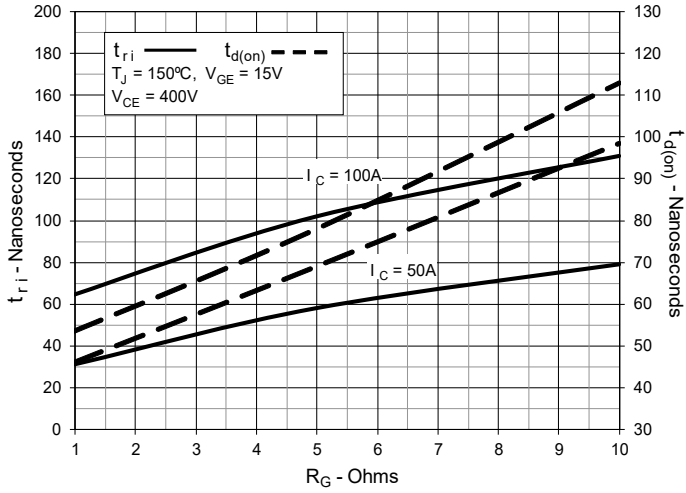
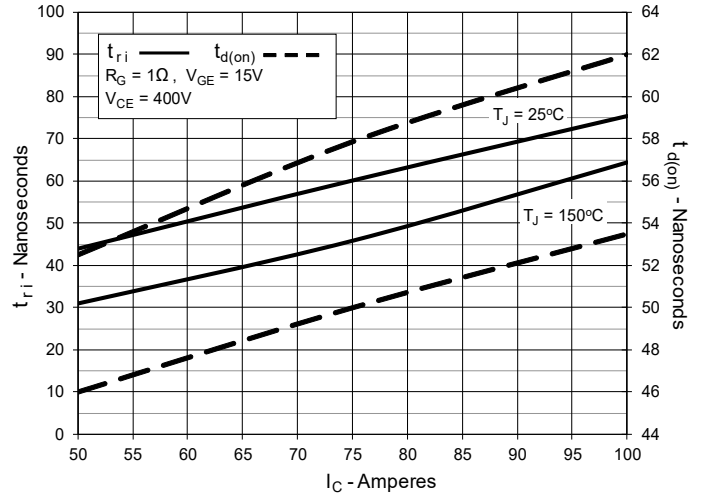
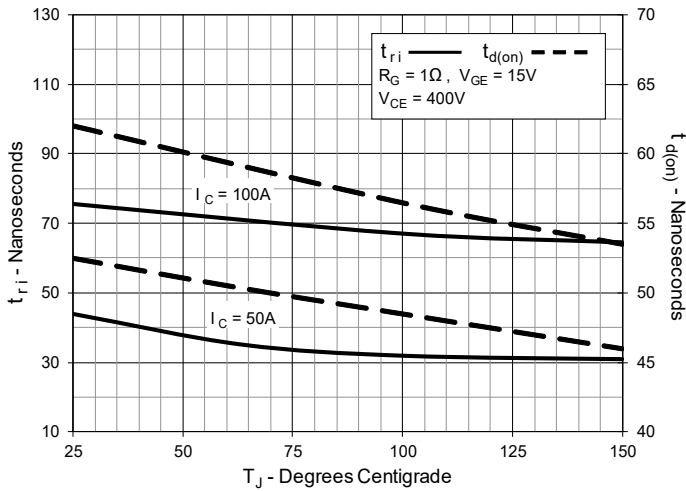
**Fig. 4. Dependence of  $V_{CE(sat)}$  on Junction Temperature**

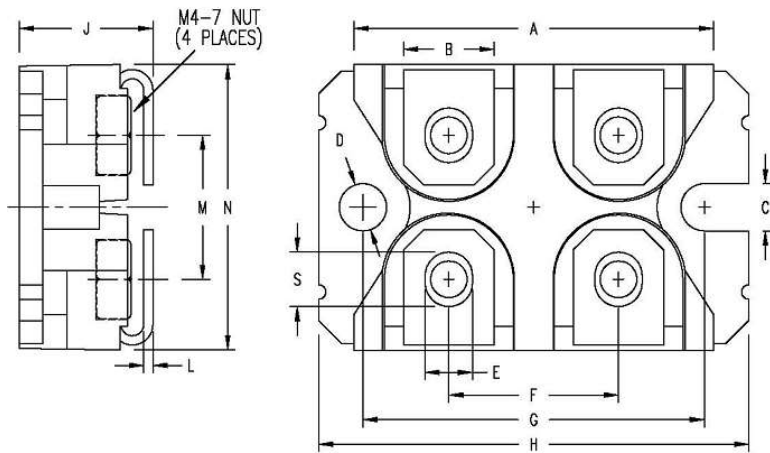
**Fig. 5. Collector-to-Emitter Voltage vs. Gate-to-Emitter Voltage**

**Fig. 6. Input Admittance**

**Fig. 7. Transconductance**

**Fig. 8. Gate Charge**

**Fig. 9. Capacitance**

**Fig. 10. Reverse-Bias Safe Operating Area**

**Fig. 11. Maximum Transient Thermal Impedance**

**Fig. 12. Inductive Switching Energy Loss vs. Gate Resistance**

**Fig. 13. Inductive Switching Energy Loss vs. Collector Current**

**Fig. 14. Inductive Switching Energy Loss vs. Junction Temperature**

**Fig. 15. Inductive Turn-off Switching Times vs. Gate Resistance**

**Fig. 16. Inductive Turn-off Switching Times vs. Collector Current**

**Fig. 17. Inductive Turn-off Switching Times vs. Junction Temperature**

**Fig. 18. Inductive Turn-on Switching Times vs. Gate Resistance**

**Fig. 19. Inductive Turn-on Switching Times vs. Collector Current**

**Fig. 20. Inductive Turn-on Switching Times vs. Junction Temperature**

**SOT-227B miniBLOC (IXYN)**

SYM	INCHES		MILLIMETERS	
	MIN	MAX	MIN	MAX
A	1.224	1.260	31.10	32.00
B	.303	.327	7.70	8.30
C	.161	.173	4.10	4.40
D	.161	.173	4.10	4.40
E	.161	.173	4.10	4.40
F	.587	.598	14.90	15.20
G	1.181	1.201	30.00	30.50
H	1.488	1.508	37.80	38.30
J	.461	.484	11.70	12.30
L	.030	.033	0.75	0.85
M	.492	.512	12.50	13.00
N	.984	1.004	25.00	25.50
O	.075	.087	1.90	2.20
S	.181	.193	4.60	4.90
U	.000	.005	0.00	0.13

- NUT MATERIAL:  
 STANDARD - Low carbon steel with Ni plating.  
 OPTIONAL - Brass Nut is available.  
 PART NUMBER-BN
- ALL METAL SURFACE ARE PRE NI PLATED EXCEPT TRIM AREA.



---

Disclaimer Notice - Information furnished is believed to be accurate and reliable. However, users should independently evaluate the suitability of and test each product selected for their own applications. Littelfuse products are not designed for, and may not be used in, all applications. Read complete Disclaimer Notice at [www.littelfuse.com/disclaimer-electronics](http://www.littelfuse.com/disclaimer-electronics).

Littelfuse reserves the right to change limits, test conditions, and dimensions.

---