

XPT™ 650V IGBT GenX4™ w/ Sonic Diode

IXXH60N65B4H1

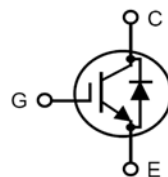

Extreme Light Punch Through
IGBT for 5-30 kHz Switching

$V_{CES} = 650V$
 $I_{C110} = 60A$
 $V_{CE(sat)} \leq 2.2V$
 $t_{fi(typ)} = 43ns$

| Symbol | Test Conditions | Maximum Ratings | |
|-------------------------------|---|---|------------|
| V_{CES} | $T_J = 25^\circ C$ to $175^\circ C$ | 650 | V |
| V_{CGR} | $T_J = 25^\circ C$ to $175^\circ C$, $R_{GE} = 1M\Omega$ | 650 | V |
| V_{GES} | Continuous | ± 20 | V |
| V_{GEM} | Transient | ± 30 | V |
| I_{C25} | $T_C = 25^\circ C$ (Chip Capability) | 145 | A |
| I_{C110} | $T_C = 110^\circ C$ | 60 | A |
| I_{F110} | $T_C = 110^\circ C$ | 47 | A |
| I_{CM} | $T_C = 25^\circ C$, 1ms | 265 | A |
| SSOA (RBSOA) | $V_{GE} = 15V$, $T_{VJ} = 150^\circ C$, $R_G = 5\Omega$ Clamped Inductive Load | $I_{CM} = 120$ @ $V_{CE} \leq V_{CES}$ | A |
| t_{sc} (SCSOA) | $V_{GE} = 15V$, $V_{CE} = 360V$, $T_J = 150^\circ C$ $R_G = 82\Omega$, Non Repetitive | 10 | μs |
| P_C | $T_C = 25^\circ C$ | 536 | W |
| T_J | | -55 ... +175 | $^\circ C$ |
| T_{JM} | | 175 | $^\circ C$ |
| T_{stg} | | -55 ... +175 | $^\circ C$ |
| T_L | Maximum Lead Temperature for Soldering | 300 | $^\circ C$ |
| T_{SOLD} | 1.6 mm (0.062in.) from Case for 10s | 260 | $^\circ C$ |
| M_d | Mounting Torque | 1.13/10 | Nm/lb.in |
| Weight | | 6 | g |

TO-247



G = Gate C = Collector
E = Emitter Tab = Collector

Features

- Optimized for 5-30kHz Switching
- Square RBSOA
- Anti-Parallel Sonic Diode
- Short Circuit Capability
- International Standard Package

Advantages

- High Power Density
- Extremely Rugged
- Low Gate Drive Requirement

Applications

- Power Inverters
- UPS
- Motor Drives
- SMPS
- PFC Circuits
- Battery Chargers
- Welding Machines
- Lamp Ballasts

| Symbol | Test Conditions ($T_J = 25^\circ C$, Unless Otherwise Specified) | Characteristic Values | | |
|---------------|---|-----------------------|------------|--------------------|
| | | Min. | Typ. | Max. |
| BV_{CES} | $I_C = 250\mu A$, $V_{GE} = 0V$ | 650 | | V |
| $V_{GE(th)}$ | $I_C = 250\mu A$, $V_{CE} = V_{GE}$ | 4.0 | | 6.5 V |
| I_{CES} | $V_{CE} = V_{CES}$, $V_{GE} = 0V$ $T_J = 150^\circ C$ | | | 25 μA 3 mA |
| I_{GES} | $V_{CE} = 0V$, $V_{GE} = \pm 20V$ | | | ± 100 nA |
| $V_{CE(sat)}$ | $I_C = 60A$, $V_{GE} = 15V$, Note 1 $T_J = 150^\circ C$ | | 1.8 2.1 | 2.2 V V |

| Symbol Test Conditions ($T_J = 25^\circ\text{C}$ Unless Otherwise Specified) | | Characteristic Values | | |
|--|---|-----------------------|------|-------------------------|
| | | Min. | Typ. | Max. |
| g_{fs} | $I_C = 60\text{A}, V_{CE} = 10\text{V}, \text{Note 1}$ | 17 | 28 | S |
| C_{ies} | $V_{CE} = 25\text{V}, V_{GE} = 0\text{V}, f = 1\text{MHz}$ | | 2590 | pF |
| C_{oes} | | | 310 | pF |
| C_{res} | | | 40 | pF |
| $Q_{g(on)}$ | $I_C = 60\text{A}, V_{GE} = 15\text{V}, V_{CE} = 0.5 \cdot V_{CES}$ | | 86 | nC |
| Q_{ge} | | | 22 | nC |
| Q_{gc} | | | 35 | nC |
| $t_{d(on)}$ | Inductive load, $T_J = 25^\circ\text{C}$ $I_C = 60\text{A}, V_{GE} = 15\text{V}$ $V_{CE} = 400\text{V}, R_G = 5\Omega$ Note 2 | | 19 | ns |
| t_{ri} | | | 80 | ns |
| E_{on} | | | 3.2 | mJ |
| $t_{d(off)}$ | | | 107 | ns |
| t_{fi} | | | 43 | ns |
| E_{off} | | | 1.1 | mJ |
| $t_{d(on)}$ | Inductive load, $T_J = 150^\circ\text{C}$ $I_C = 60\text{A}, V_{GE} = 15\text{V}$ $V_{CE} = 400\text{V}, R_G = 5\Omega$ Note 2 | | 20 | ns |
| t_{ri} | | | 74 | ns |
| E_{on} | | | 4.2 | mJ |
| $t_{d(off)}$ | | | 120 | ns |
| t_{fi} | | | 88 | ns |
| E_{off} | | | 1.8 | mJ |
| R_{thJC} | | | | 0.28 $^\circ\text{C/W}$ |
| R_{thCS} | | 0.21 | | $^\circ\text{C/W}$ |

Reverse Sonic Diode (FRD)

| Symbol Test Conditions ($T_J = 25^\circ\text{C}$ Unless Otherwise Specified) | | Characteristic Values | | |
|--|--|---------------------------|------|-------------------------|
| | | Min. | Typ. | Max. |
| V_F | $I_F = 30\text{A}, V_{GE} = 0\text{V}, \text{Note 1}$ | | | 2.5 V |
| | | $T_J = 150^\circ\text{C}$ | 1.5 | V |
| I_{RM} | $I_F = 30\text{A}, V_{GE} = 0\text{V},$ $-di_F/dt = 900\text{A}/\mu\text{s}, V_R = 300\text{V}$ | $T_J = 150^\circ\text{C}$ | 25 | A |
| t_{rr} | | $T_J = 150^\circ\text{C}$ | 78 | ns |
| R_{thJC} | | | | 0.60 $^\circ\text{C/W}$ |

Notes:

1. Pulse test, $t \leq 300\mu\text{s}$, duty cycle, $d \leq 2\%$.
2. Switching times & energy losses may increase for higher V_{CE} (clamp), T_J or R_G .

TO-247 (IXXH) Outline

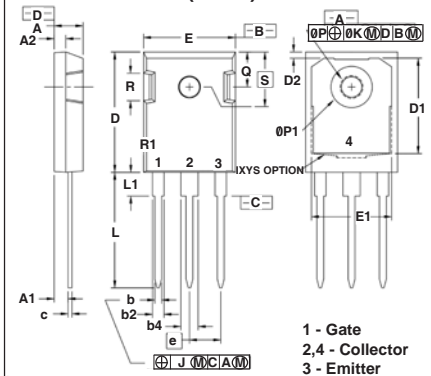

| SYM | INCHES | | MILLIMETERS | |
|-----------|----------|------|-------------|-------|
| | MIN | MAX | MIN | MAX |
| A | .190 | .205 | 4.83 | 5.21 |
| A1 | .090 | .100 | 2.29 | 2.54 |
| A2 | .075 | .085 | 1.91 | 2.16 |
| b | .045 | .055 | 1.14 | 1.40 |
| b2 | .075 | .087 | 1.91 | 2.20 |
| b4 | .115 | .126 | 2.92 | 3.20 |
| C | .024 | .031 | 0.61 | 0.80 |
| D | .819 | .840 | 20.80 | 21.34 |
| D1 | .650 | .690 | 16.51 | 17.53 |
| D2 | .035 | .050 | 0.89 | 1.27 |
| E | .620 | .635 | 15.75 | 16.13 |
| E1 | .545 | .565 | 13.84 | 14.35 |
| e | .215 BSC | | 5.45 BSC | |
| J | -- | .010 | -- | 0.25 |
| K | -- | .025 | -- | 0.64 |
| L | .780 | .810 | 19.81 | 20.57 |
| L1 | .150 | .170 | 3.81 | 4.32 |
| ϕP | .140 | .144 | 3.55 | 3.65 |
| $\phi P1$ | .275 | .290 | 6.99 | 7.37 |
| Q | .220 | .244 | 5.59 | 6.20 |
| R | .170 | .190 | 4.32 | 4.83 |
| S | .242 BSC | | 6.15 BSC | |

IXYS Reserves the Right to Change Limits, Test Conditions, and Dimensions.

| | | | | | | | | | | |
|--|-----------|-----------|-----------|-----------|--------------|--------------|--------------|--------------|--------------|-------------|
| IXYS MOSFETs and IGBTs are covered by one or more of the following U.S. patents: | 4,835,592 | 4,931,844 | 5,049,961 | 5,237,481 | 6,162,665 | 6,404,065 B1 | 6,683,344 | 6,727,585 | 7,005,734 B2 | 7,157,338B2 |
| | 4,860,072 | 5,017,508 | 5,063,307 | 5,381,025 | 6,259,123 B1 | 6,534,343 | 6,710,405 B2 | 6,759,692 | 7,063,975 B2 | |
| | 4,881,106 | 5,034,796 | 5,187,117 | 5,486,715 | 6,306,728 B1 | 6,583,505 | 6,710,463 | 6,771,478 B2 | 7,071,537 | |

Fig. 1. Output Characteristics @ $T_J = 25^\circ\text{C}$

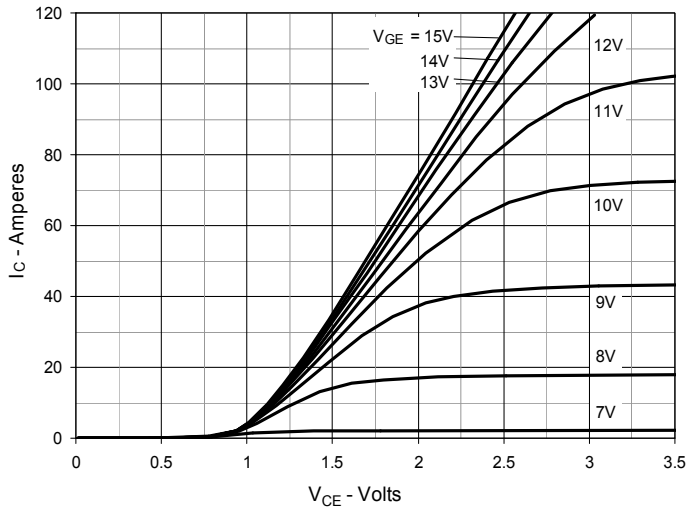

Fig. 2. Extended Output Characteristics @ $T_J = 25^\circ\text{C}$

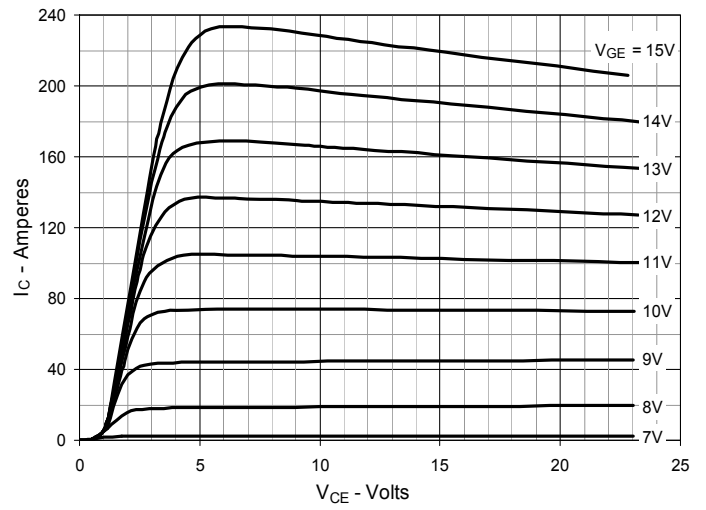

Fig. 3. Output Characteristics @ $T_J = 150^\circ\text{C}$

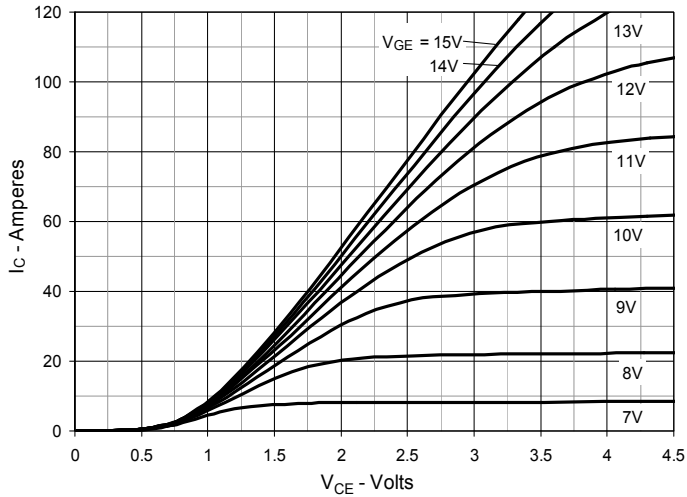

Fig. 4. Dependence of $V_{CE(sat)}$ on Junction Temperature

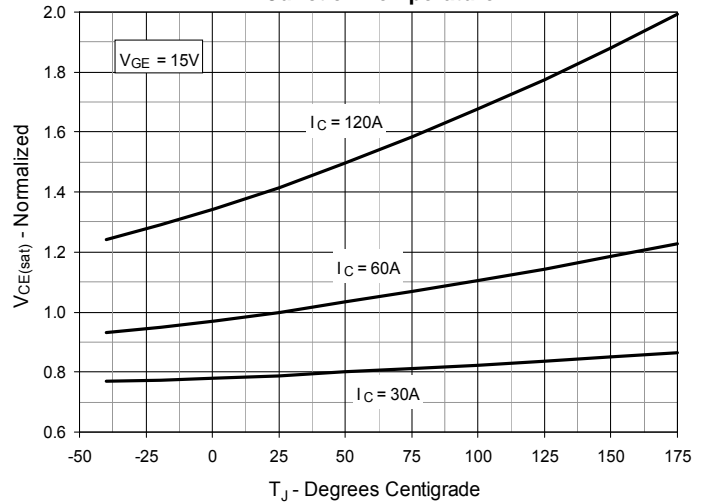

Fig. 5. Collector-to-Emitter Voltage vs. Gate-to-Emitter Voltage

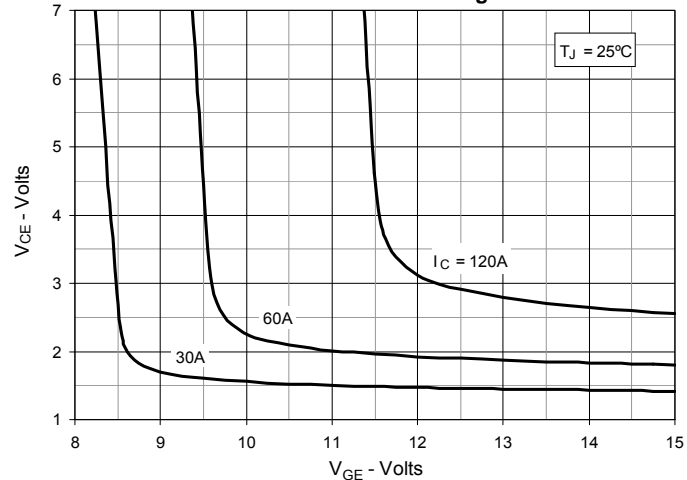

Fig. 6. Input Admittance

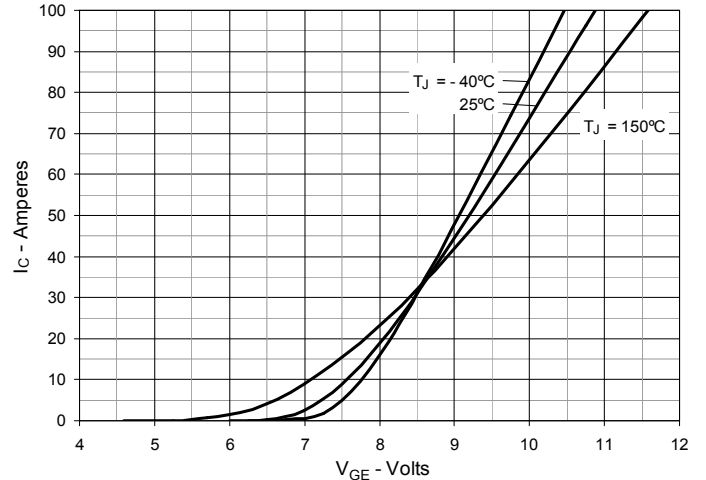

Fig. 7. Transconductance

Fig. 8. Gate Charge

Fig. 9. Capacitance

Fig. 10. Reverse-Bias Safe Operating Area

Fig. 11. Maximum Transient Thermal Impedance (IGBT)

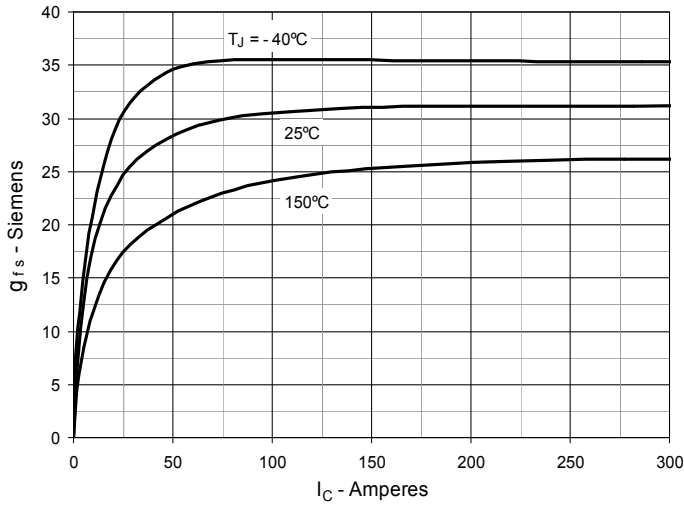
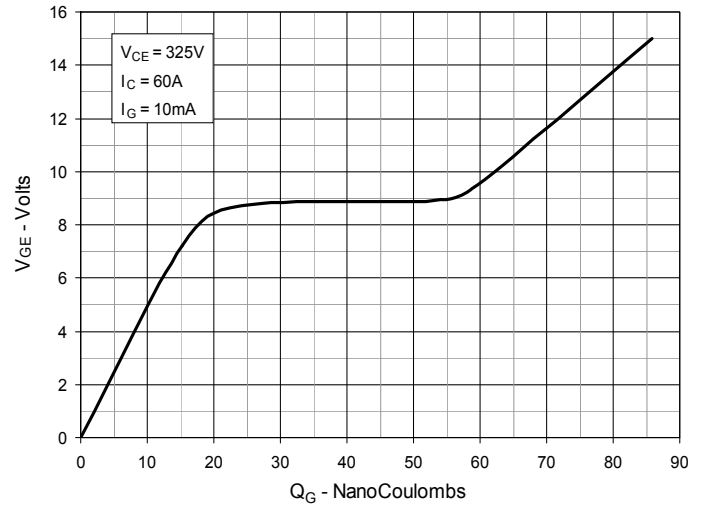
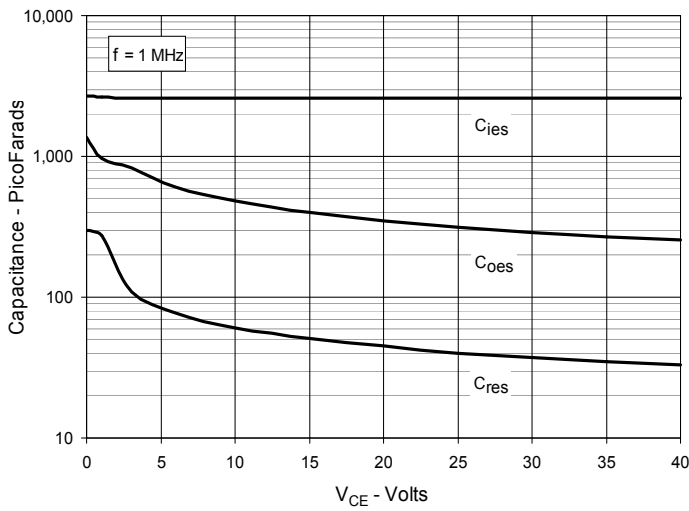
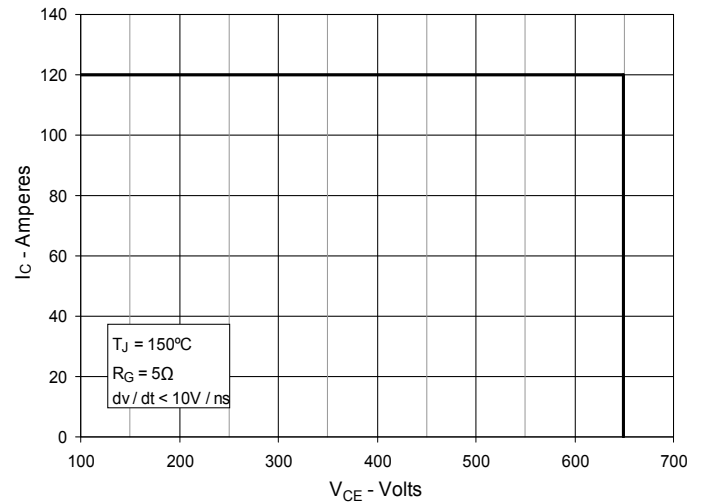
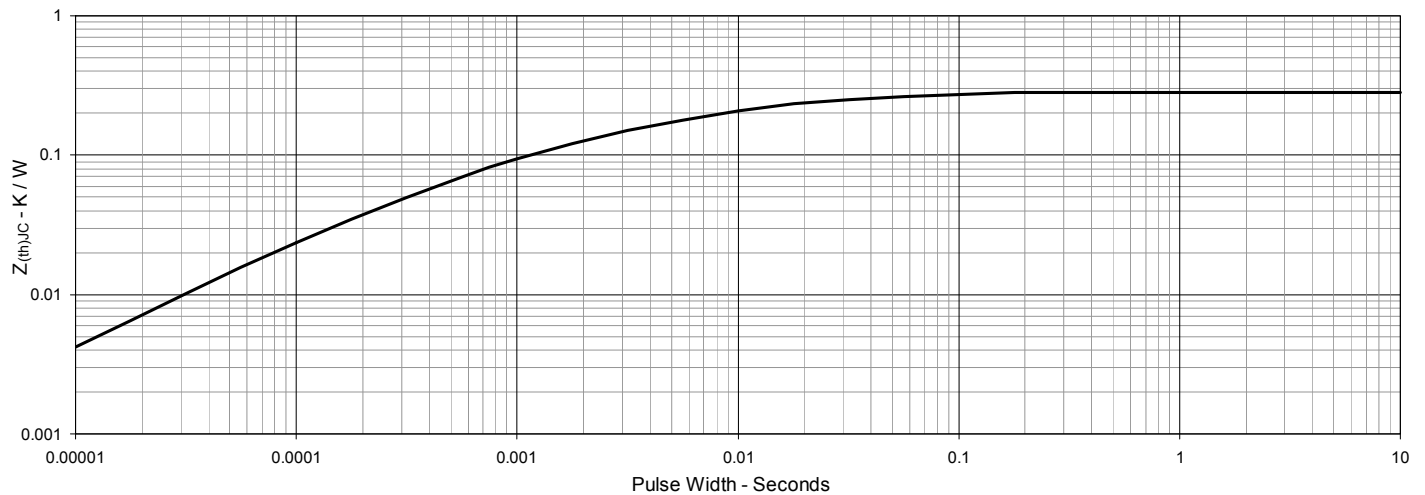
Fig. 12. Inductive Switching Energy Loss vs. Gate Resistance

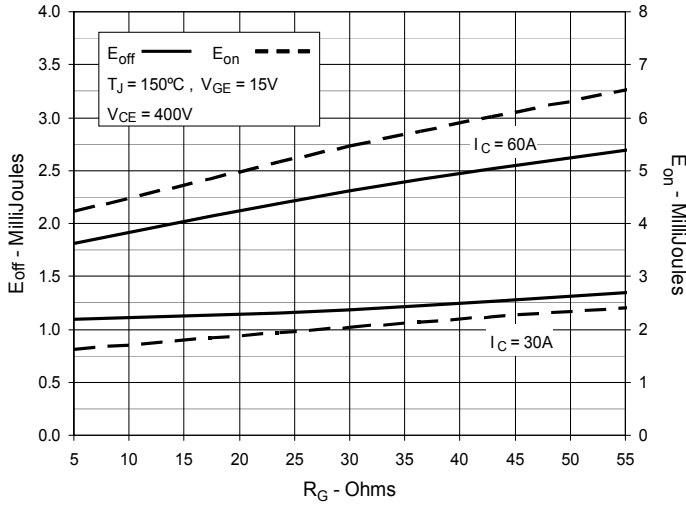

Fig. 13. Inductive Switching Energy Loss vs. Collector Current

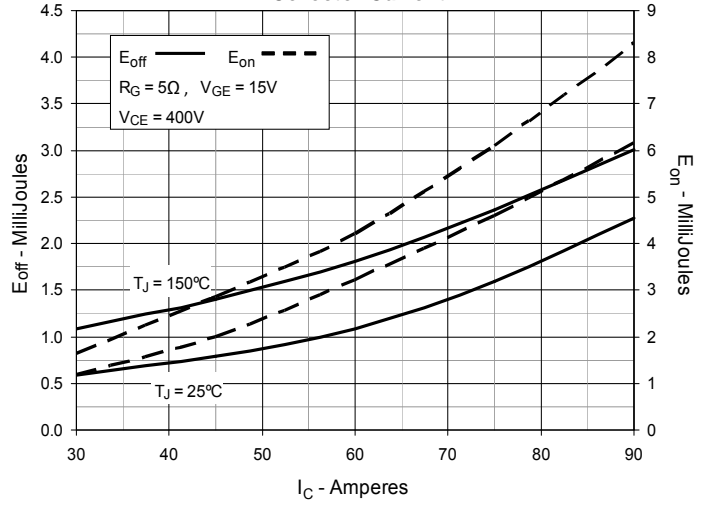

Fig. 14. Inductive Switching Energy Loss vs. Junction Temperature

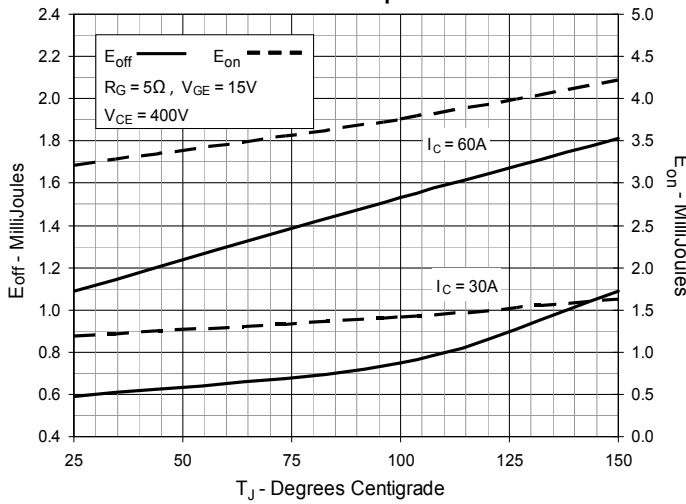

Fig. 15. Inductive Turn-off Switching Times vs. Gate Resistance

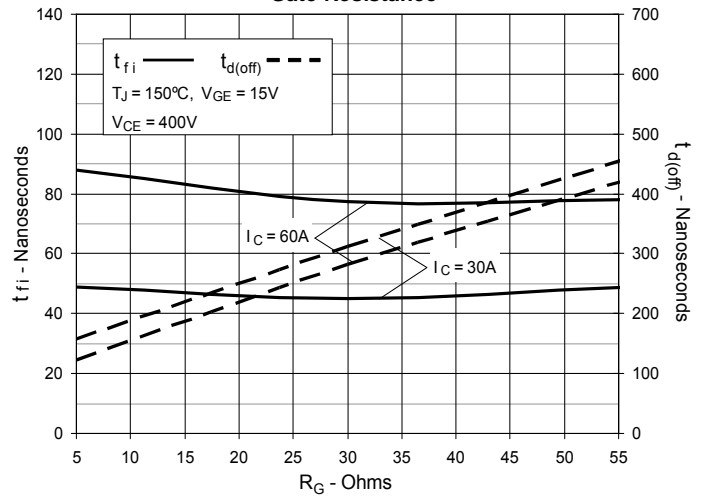

Fig. 16. Inductive Turn-off Switching Times vs. Collector Current

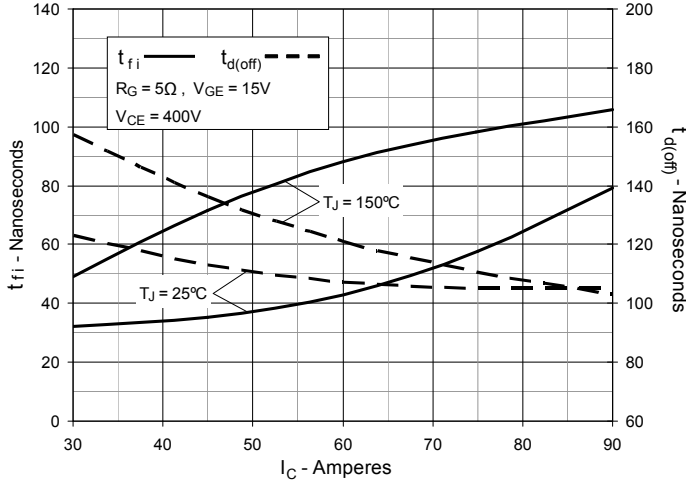

Fig. 17. Inductive Turn-off Switching Times vs. Junction Temperature

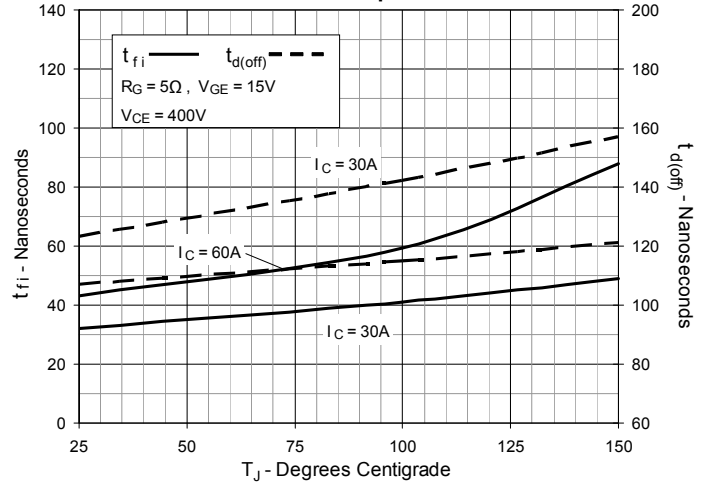

Fig. 18. Inductive Turn-on Switching Times vs. Gate Resistance

Fig. 19. Inductive Turn-on Switching Times vs. Collector Current

Fig. 20. Inductive Turn-on Switching Times vs. Junction Temperature

Fig. 21. Forward Current vs. Forward Voltage

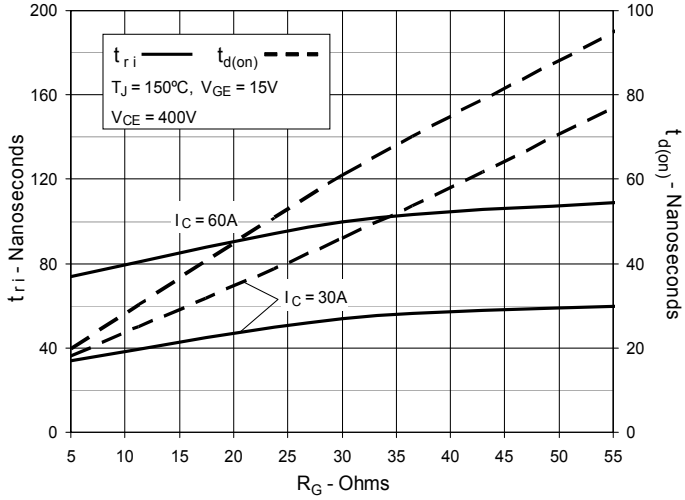
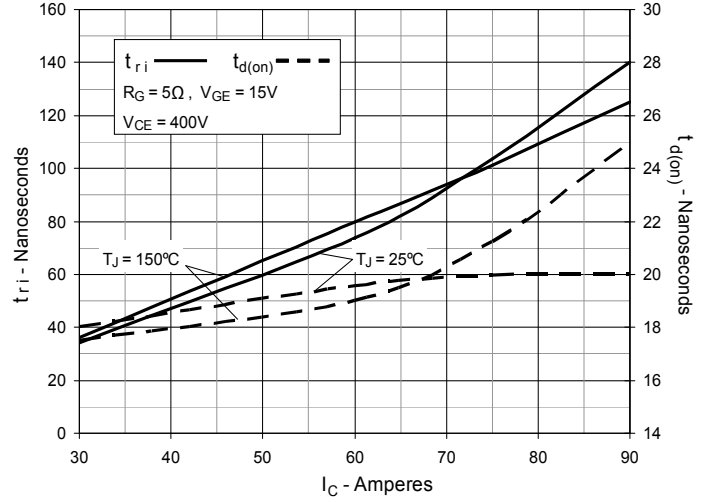
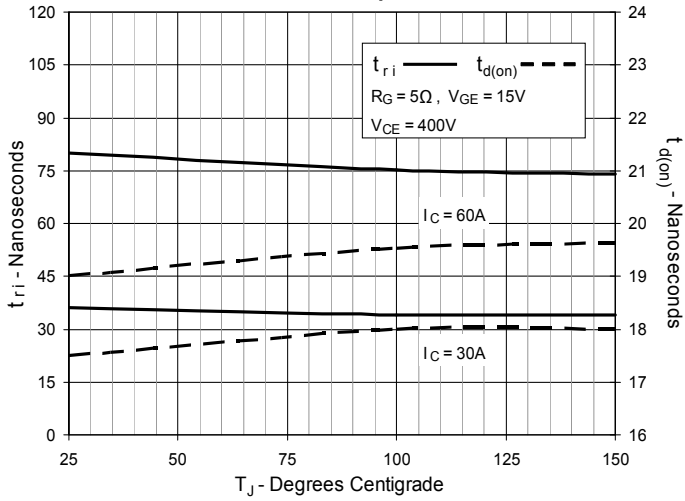
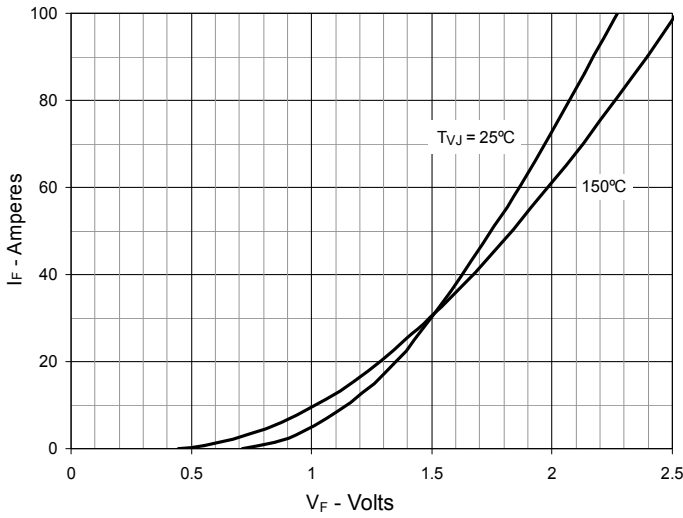

Fig. 22. Reverse Recovery Charge Q_{RR} vs. $-di_F/dt$

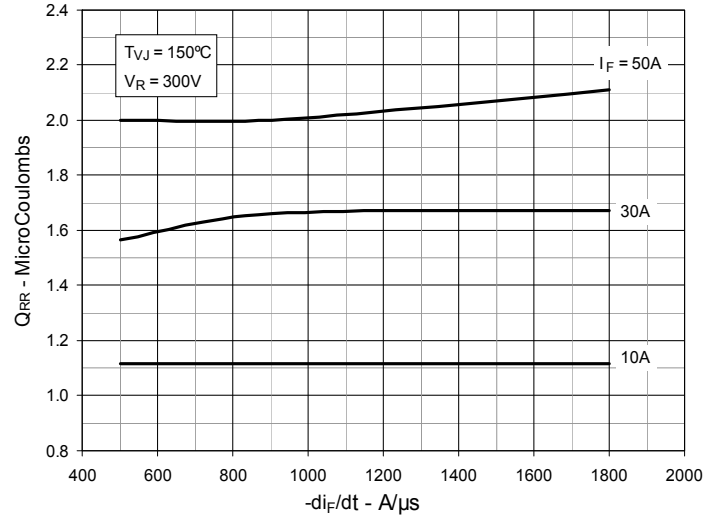

Fig. 23. Peak Reverse Current I_{RR} vs. $-di_F/dt$

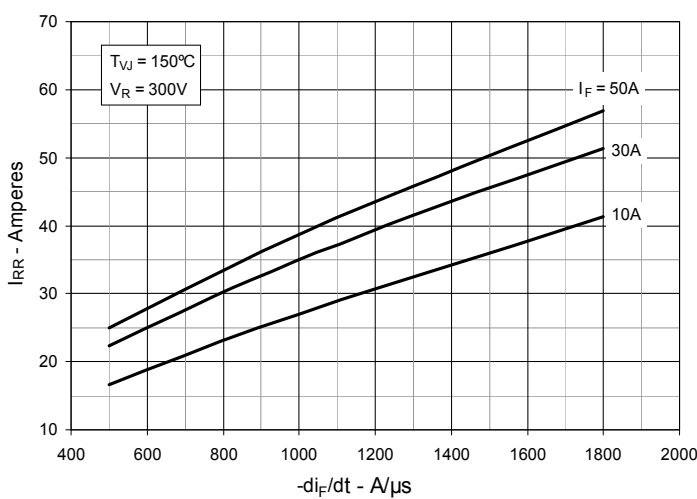

Fig. 24. Recover Time t_{RR} vs. $-di_F/dt$

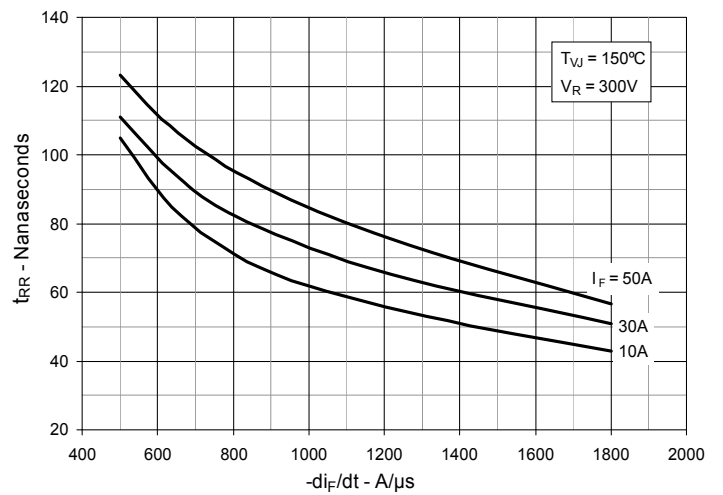

Fig. 25. Recovery Energy E_{REC} vs. $-di_F/dt$

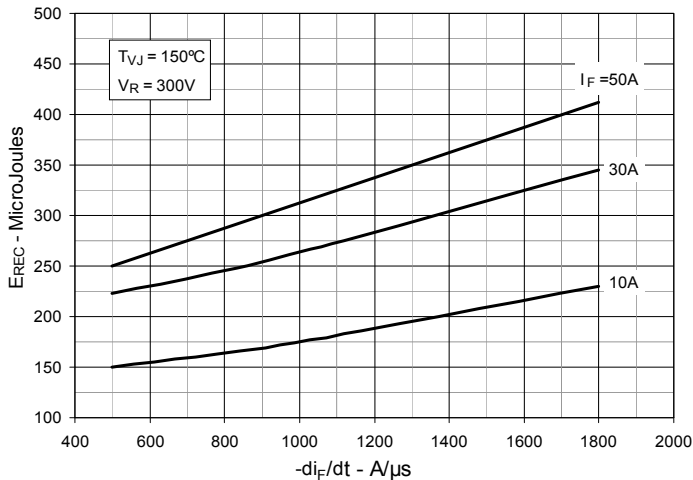

Fig. 26. Dynamic Parameters Q_{RR} , I_{RR} vs. Virtual Junction Temperature T_{VJ}

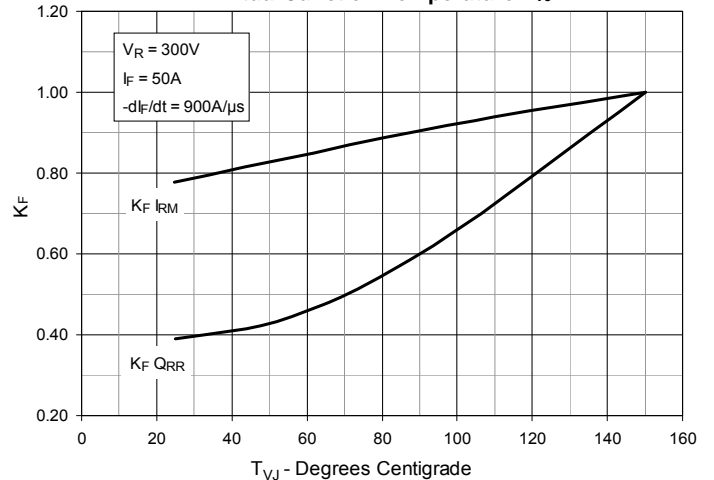
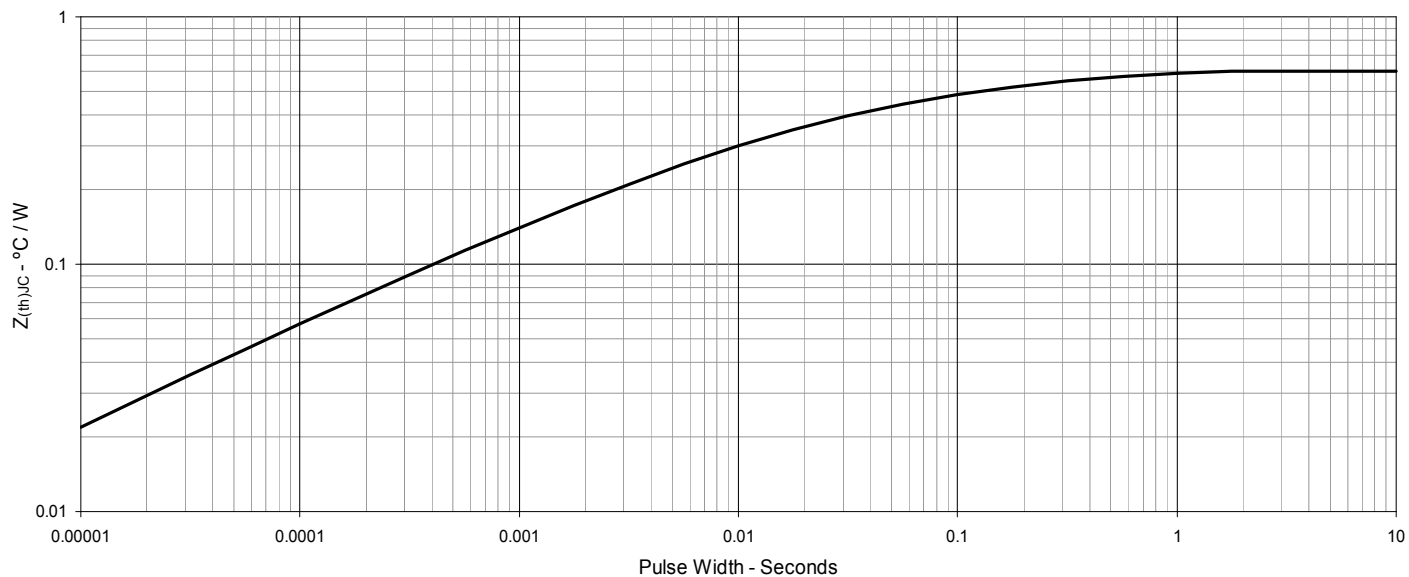

Fig. 27. Maximum Transient Thermal Impedance (Diode)





Disclaimer Notice - Information furnished is believed to be accurate and reliable. However, users should independently evaluate the suitability of and test each product selected for their own applications. Littelfuse products are not designed for, and may not be used in, all applications. Read complete Disclaimer Notice at www.littelfuse.com/disclaimer-electronics.