

XPT™ 650V GenX4™ w/ Sonic Diode

IXXK110N65B4H1 IXXX110N65B4H1

$V_{CES} = 650V$
 $I_{C110} = 110A$
 $V_{CE(sat)} \leq 2.10V$
 $t_{fi(typ)} = 43ns$

Extreme Light Punch Through
IGBT for 10-30kHz Switching

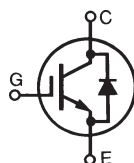

Symbol	Test Conditions	Maximum Ratings	
V_{CES}	$T_J = 25^\circ C$ to $175^\circ C$	650	V
V_{CGR}	$T_J = 25^\circ C$ to $175^\circ C$, $R_{GE} = 1M\Omega$	650	V
V_{GES}	Continuous	± 20	V
V_{GEM}	Transient	± 30	V
I_{C25}	$T_C = 25^\circ C$ (Chip Capability)	250	A
I_{LRMS}	Terminal Current Limit	160	A
I_{C110}	$T_C = 110^\circ C$	110	A
I_{F110}	$T_C = 110^\circ C$	78	A
I_{CM}	$T_C = 25^\circ C$, 1ms	570	A
SSOA (RBSOA)	$V_{GE} = 15V$, $T_{VJ} = 150^\circ C$, $R_G = 2\Omega$ Clamped Inductive Load	$I_{CM} = 220$ @ $V_{CE} \leq V_{CES}$	A
t_{sc} (SCSOA)	$V_{GE} = 15V$, $V_{CE} = 360V$, $T_J = 150^\circ C$ $R_G = 82\Omega$, Non Repetitive	10	μs
P_C	$T_C = 25^\circ C$	880	W
T_J		-55 ... +175	$^\circ C$
T_{JM}		175	$^\circ C$
T_{stg}		-55 ... +175	$^\circ C$
T_L	Maximum Lead Temperature for Soldering	300	$^\circ C$
T_{SOLD}	1.6 mm (0.062in.) from Case for 10s	260	$^\circ C$
M_d	Mounting Torque (TO-264)	1.13/10	Nm/lb.in.
F_C	Mounting Force (PLUS247)	20..120 /4.5..27	N/lb.
Weight	TO-264	10	g
	PLUS247	6	g

TO-264 (IXXK)

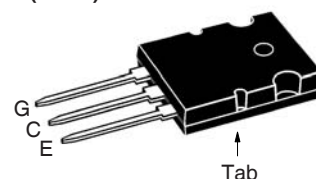

PLUS247 (IXXX)

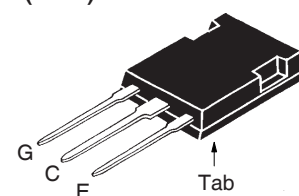

G = Gate E = Emitter
 C = Collector Tab = Collector

Features

- Optimized for 10-30kHz Switching
- Square RBSOA
- Short Circuit Capability
- Anti-Parallel Sonic Diode
- High Current Handling Capability
- International Standard Packages

Advantages

- High Power Density
- Low Gate Drive Requirement

Applications

- Power Inverters
- UPS
- Motor Drives
- SMPS
- PFC Circuits
- Battery Chargers
- Welding Machines
- Lamp Ballasts
- High Frequency Power Inverters

Symbol	Test Conditions ($T_J = 25^\circ C$, Unless Otherwise Specified)	Characteristic Values		
		Min.	Typ.	Max.
BV_{CES}	$I_C = 250\mu A$, $V_{GE} = 0V$	650		V
$V_{GE(th)}$	$I_C = 250\mu A$, $V_{CE} = V_{GE}$	4.0		6.5 V
I_{CES}	$V_{CE} = V_{CES}$, $V_{GE} = 0V$ $T_J = 150^\circ C$			25 μA 3 mA
I_{GES}	$V_{CE} = 0V$, $V_{GE} = \pm 20V$			± 100 nA
$V_{CE(sat)}$	$I_C = 110A$, $V_{GE} = 15V$, Note 1 $T_J = 150^\circ C$	1.72 2.05		2.10 V V

Symbol	Test Conditions ($T_J = 25^\circ\text{C}$ Unless Otherwise Specified)	Characteristic Values		
		Min.	Typ.	Max.
g_{fs}	$I_C = 60\text{A}, V_{CE} = 10\text{V}$, Note 1	30	52	S
C_{ies}	$V_{CE} = 25\text{V}, V_{GE} = 0\text{V}, f = 1\text{MHz}$		5500	pF
C_{oes}			470	pF
C_{res}			80	pF
$Q_{g(on)}$	$I_C = 110\text{A}, V_{GE} = 15\text{V}, V_{CE} = 0.5 \cdot V_{CES}$		183	nC
Q_{ge}			32	nC
Q_{gc}			83	nC
$t_{d(on)}$	Inductive load, $T_J = 25^\circ\text{C}$ $I_C = 55\text{A}, V_{GE} = 15\text{V}$ $V_{CE} = 400\text{V}, R_G = 2\Omega$ Note 2		26	ns
t_{ri}			40	ns
E_{on}			2.20	mJ
$t_{d(off)}$			146	ns
t_{fi}			43	ns
E_{off}			1.05	1.70 mJ
$t_{d(on)}$	Inductive load, $T_J = 150^\circ\text{C}$ $I_C = 55\text{A}, V_{GE} = 15\text{V}$ $V_{CE} = 400\text{V}, R_G = 2\Omega$ Note 2		25	ns
t_{ri}			40	ns
E_{on}			3.00	mJ
$t_{d(off)}$			140	ns
t_{fi}			110	ns
E_{off}			2.16	mJ
R_{thJC}				0.17 $^\circ\text{C/W}$
R_{thCS}		0.15		$^\circ\text{C/W}$

Reverse Sonic Diode (FRD)

Symbol	Test Conditions ($T_J = 25^\circ\text{C}$ Unless Otherwise Specified)	Characteristic Values		
		Min.	Typ.	Max.
V_F	$I_F = 100\text{A}, V_{GE} = 0\text{V}$, Note 1 $T_J = 150^\circ\text{C}$		1.7 1.8	V V
I_{RM}	$I_F = 100\text{A}, V_{GE} = 0\text{V},$ $-di_F/dt = 1500\text{A}/\mu\text{s}, V_R = 300\text{V}$ $T_J = 150^\circ\text{C}$		95	A
t_{rr}			100	ns
R_{thJC}				0.38 $^\circ\text{C/W}$

Notes:

1. Pulse test, $t \leq 300\mu\text{s}$, duty cycle, $d \leq 2\%$.
2. Switching times & energy losses may increase for higher V_{CE} (Clamp), T_J or R_G .

IXYS Reserves the Right to Change Limits, Test Conditions, and Dimensions.

Fig. 1. Output Characteristics @ $T_J = 25^\circ\text{C}$

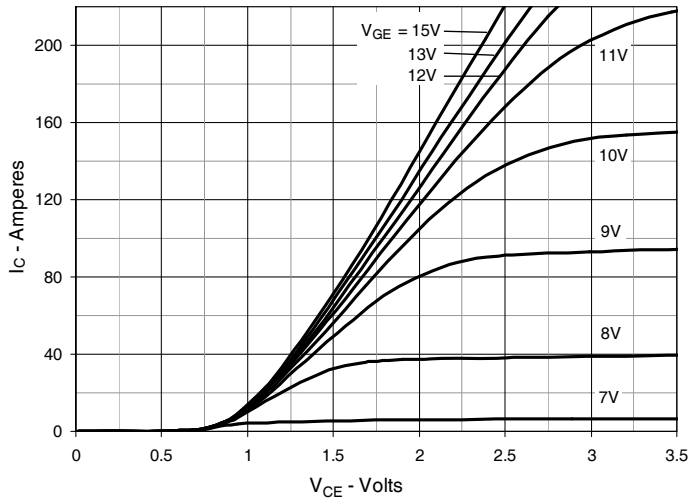

Fig. 2. Extended Output Characteristics @ $T_J = 25^\circ\text{C}$

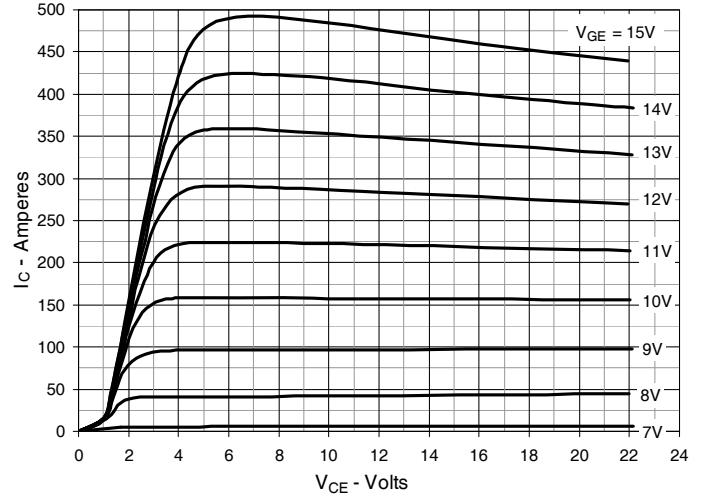

Fig. 3. Output Characteristics @ $T_J = 150^\circ\text{C}$

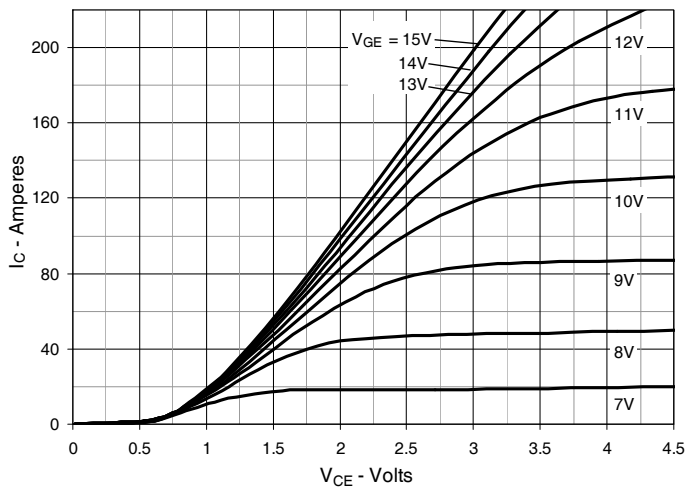

Fig. 4. Dependence of $V_{CE(sat)}$ on Junction Temperature

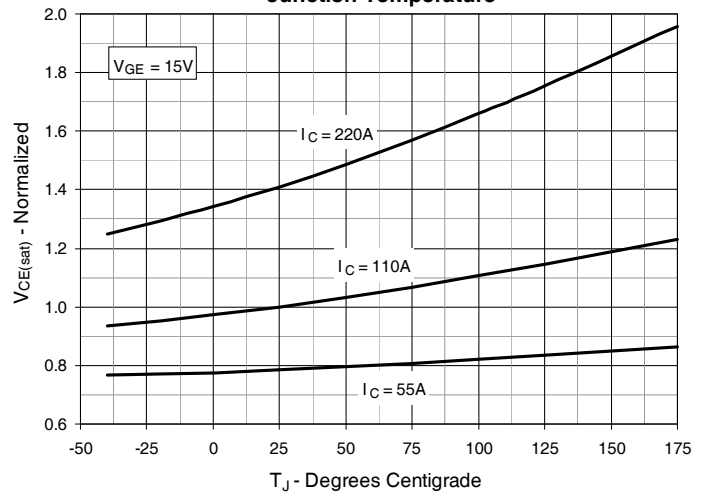

Fig. 5. Collector-to-Emitter Voltage vs. Gate-to-Emitter Voltage

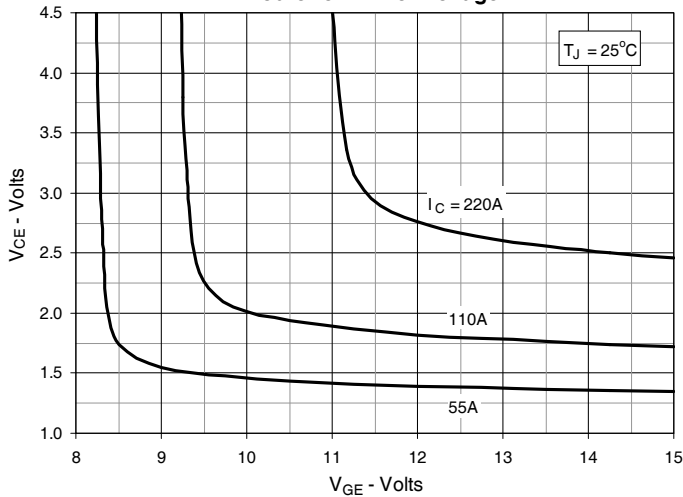

Fig. 6. Input Admittance

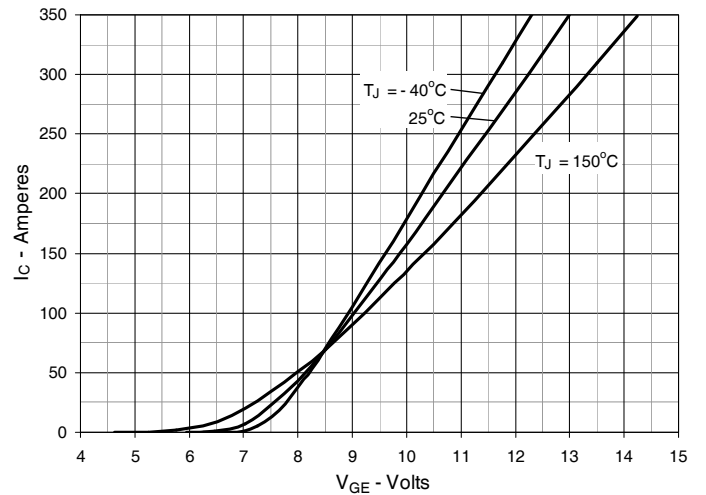

Fig. 7. Transconductance

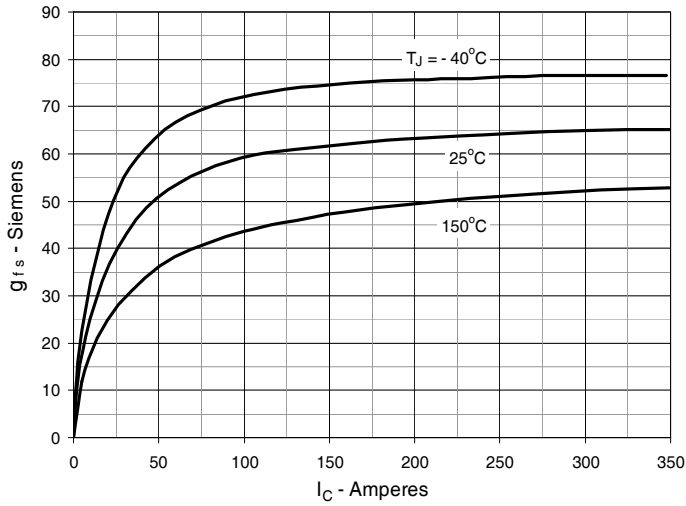

Fig. 8. Gate Charge

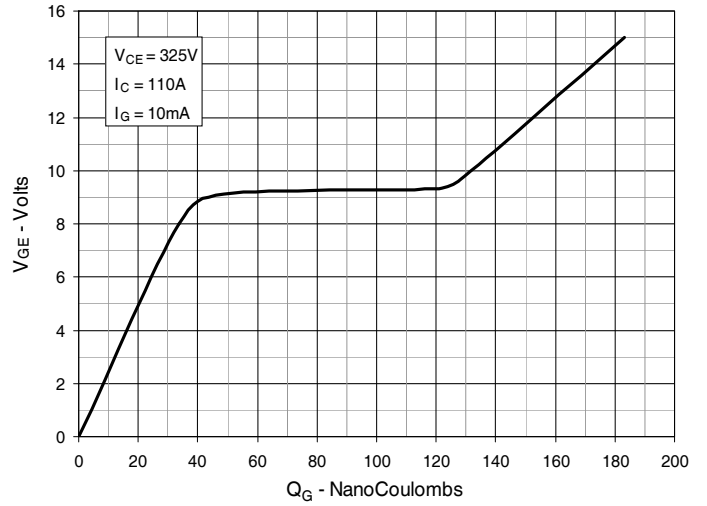

Fig. 9. Capacitance

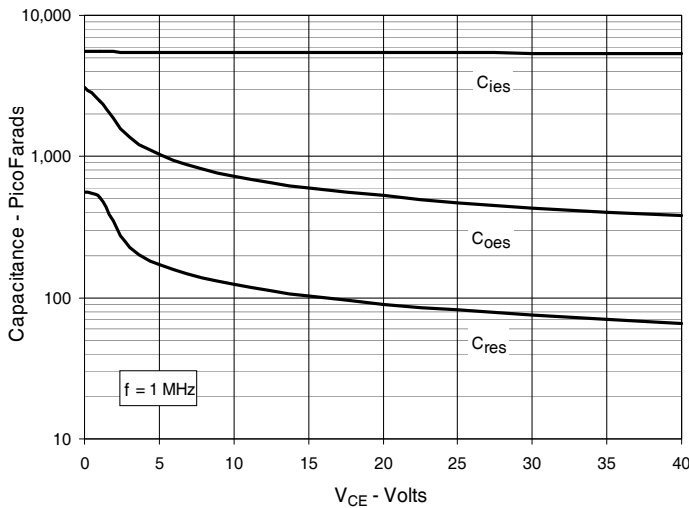

Fig. 10. Reverse-Bias Safe Operating Area

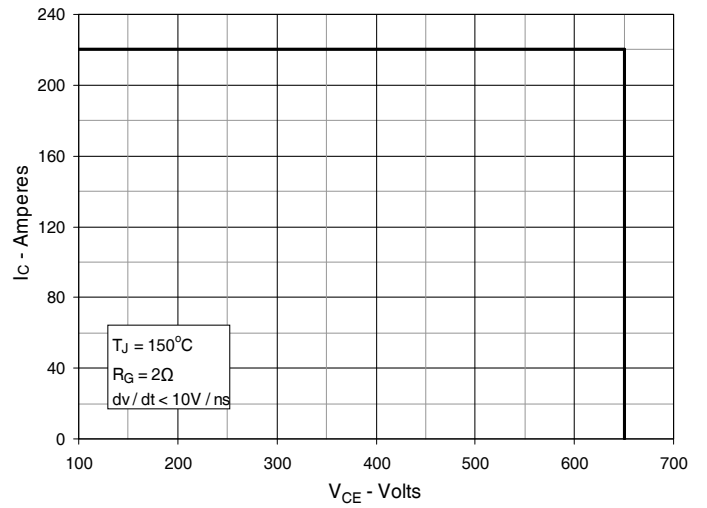

Fig. 11. Maximum Transient Thermal Impedance (IGBT)

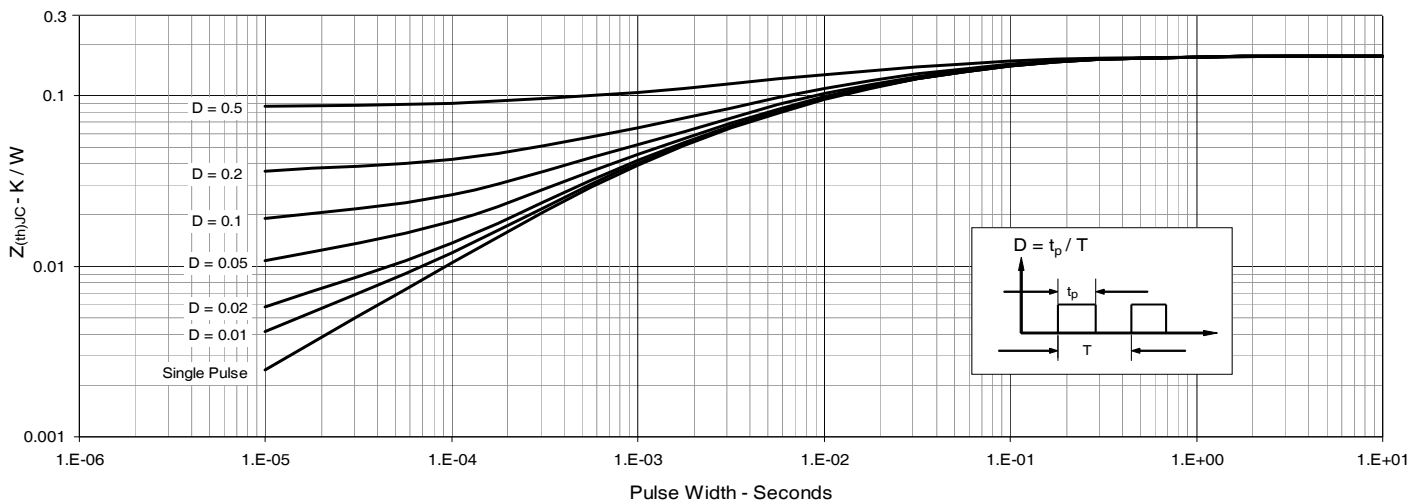

Fig. 12. Inductive Switching Energy Loss vs. Gate Resistance

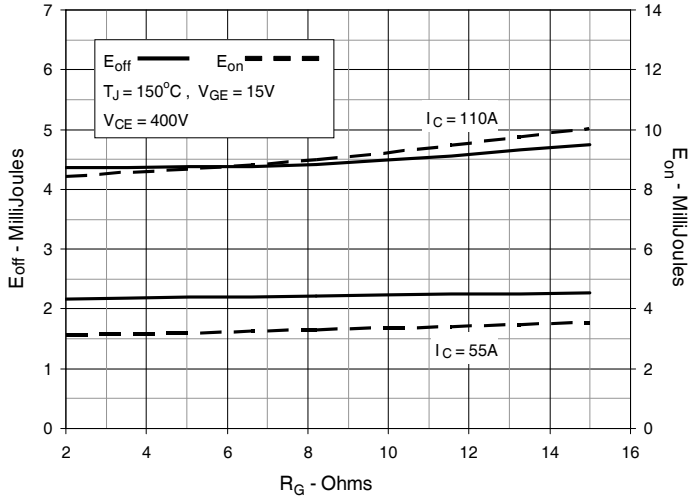

Fig. 13. Inductive Switching Energy Loss vs. Collector Current

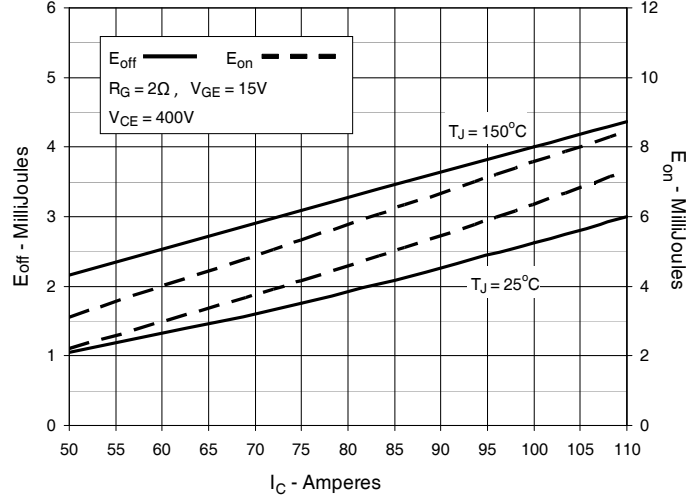

Fig. 14. Inductive Switching Energy Loss vs. Junction Temperature

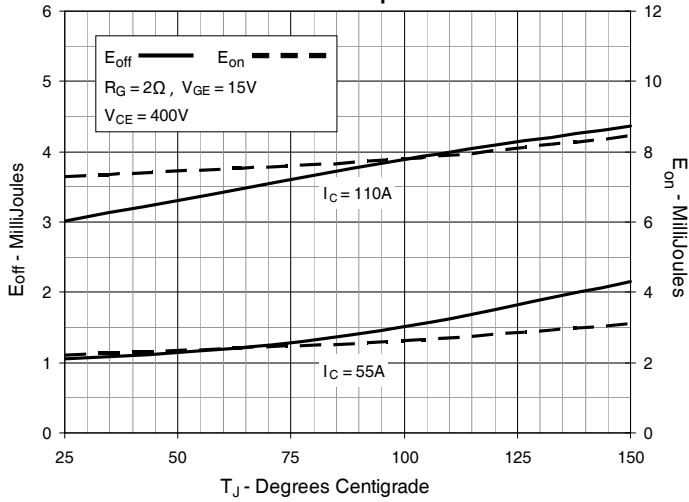

Fig. 15. Inductive Turn-off Switching Times vs. Gate Resistance

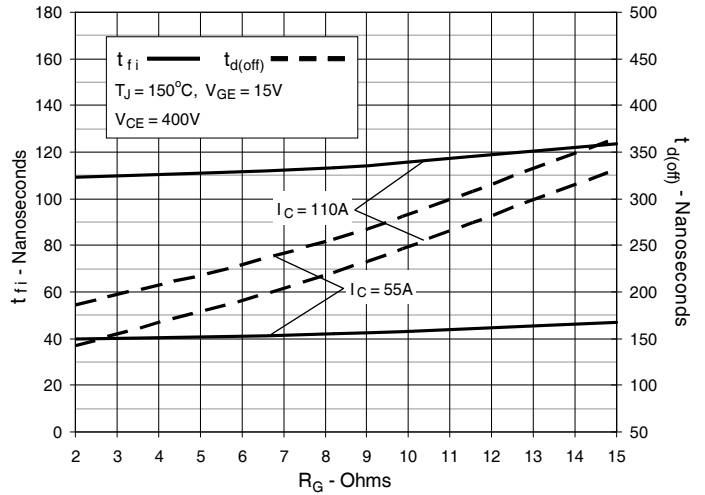

Fig. 16. Inductive Turn-off Switching Times vs. Collector Current

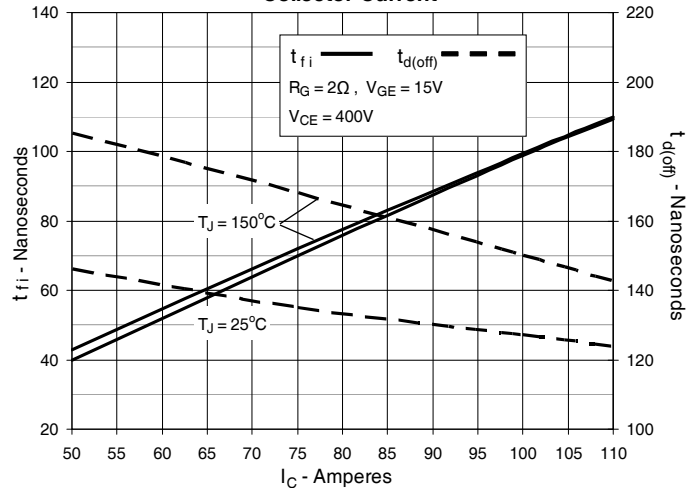

Fig. 17. Inductive Turn-off Switching Times vs. Junction Temperature

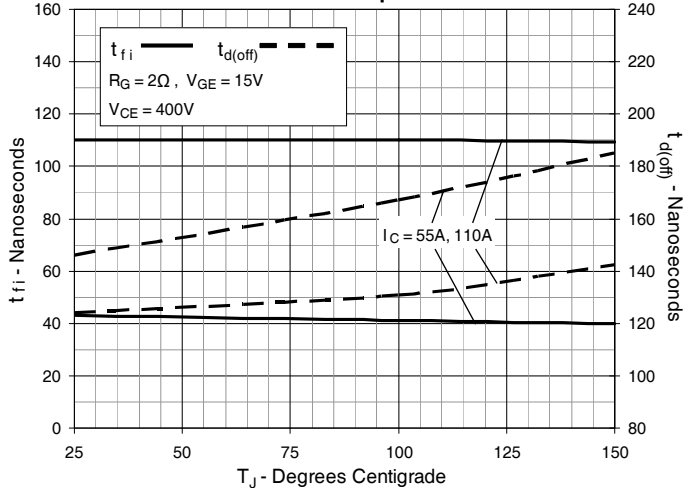

Fig. 18. Inductive Turn-on Switching Times vs. Gate Resistance

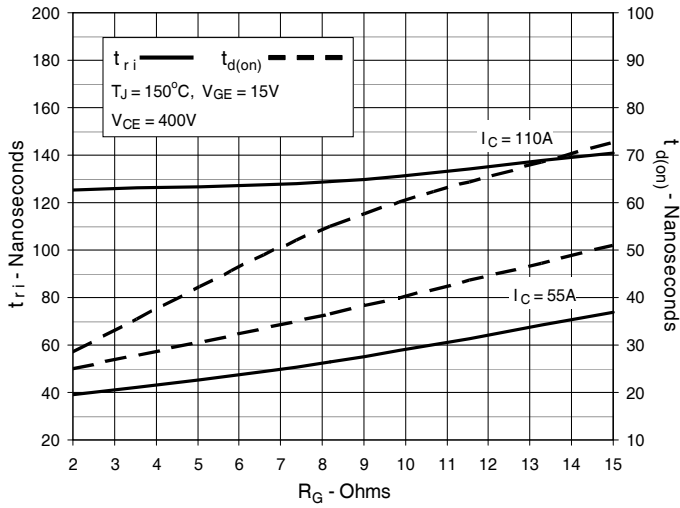

Fig. 19. Inductive Turn-on Switching Times vs. Collector Current

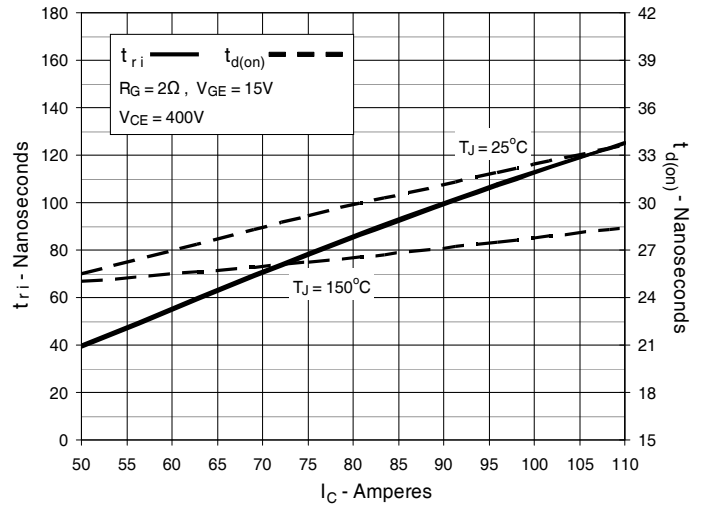

Fig. 20. Inductive Turn-on Switching Times vs. Junction Temperature

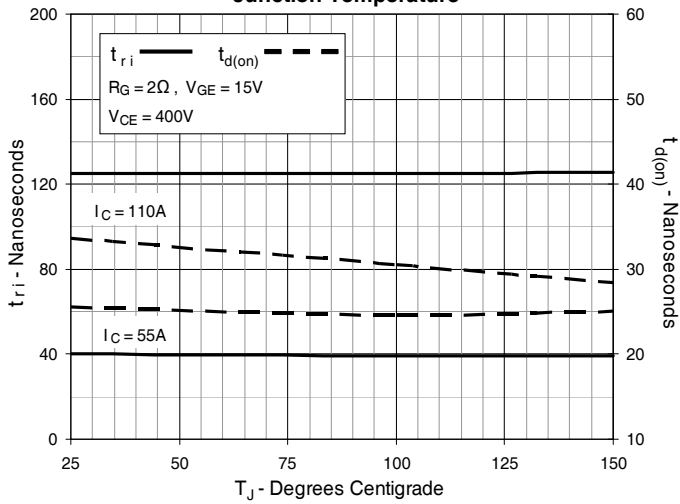

Fig. 21. Typ. Forward characteristics

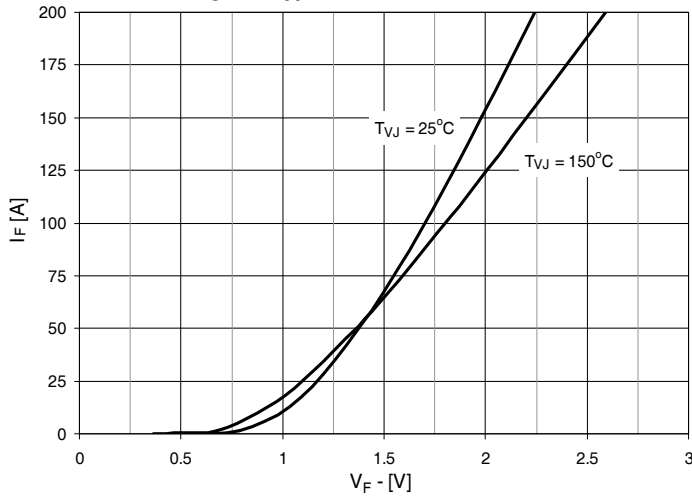

Fig. 22. Typ. Reverse Recovery Charge Q_{rr} vs. $-di_F/dt$

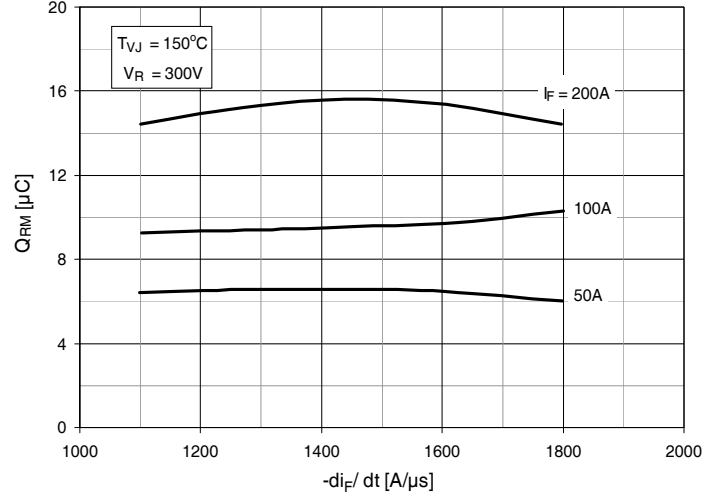

Fig. 23. Typ. Peak Reverse Current I_{RM} vs. $-di_F/dt$

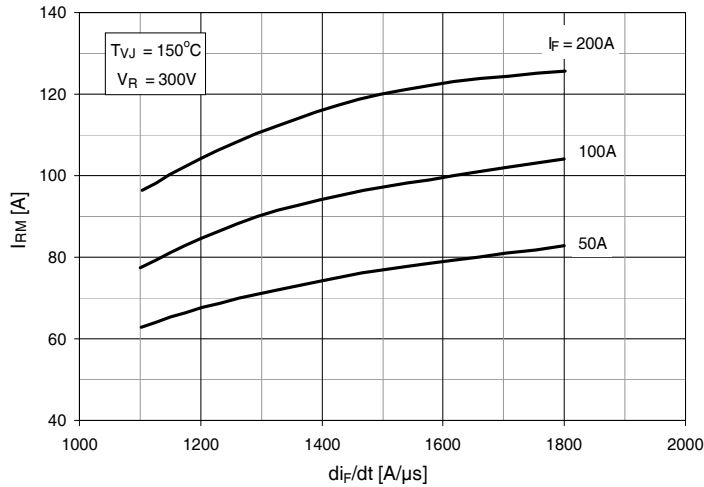

Fig. 24. Typ. Recovery Time t_{rr} vs. $-di_F/dt$

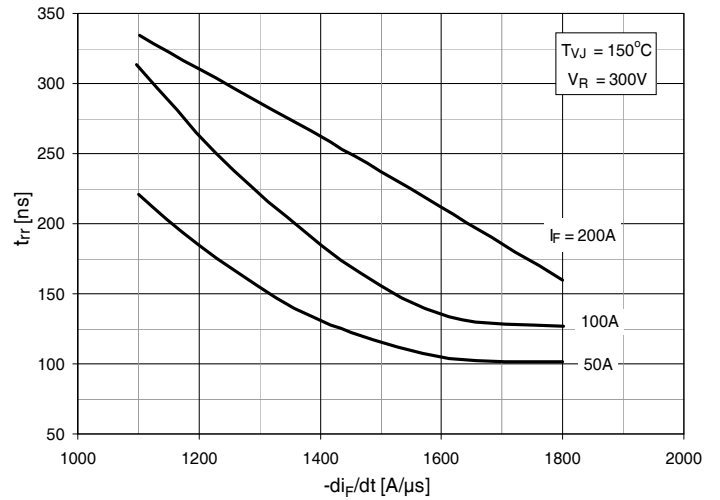

Fig. 25. Typ. Recovery Energy E_{rec} vs. $-di_F/dt$

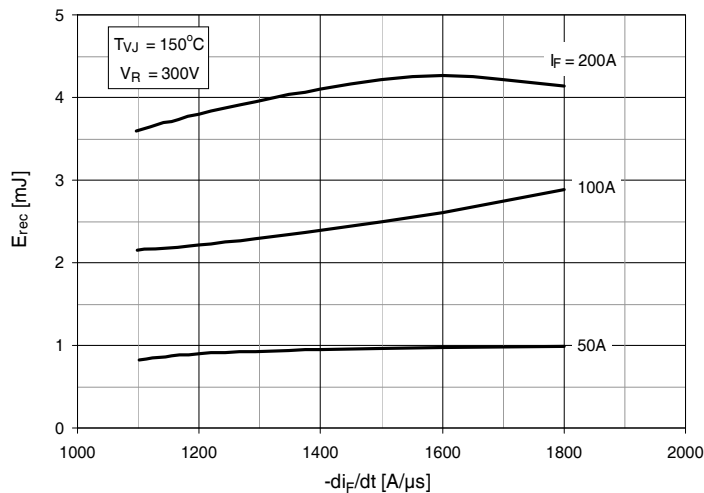
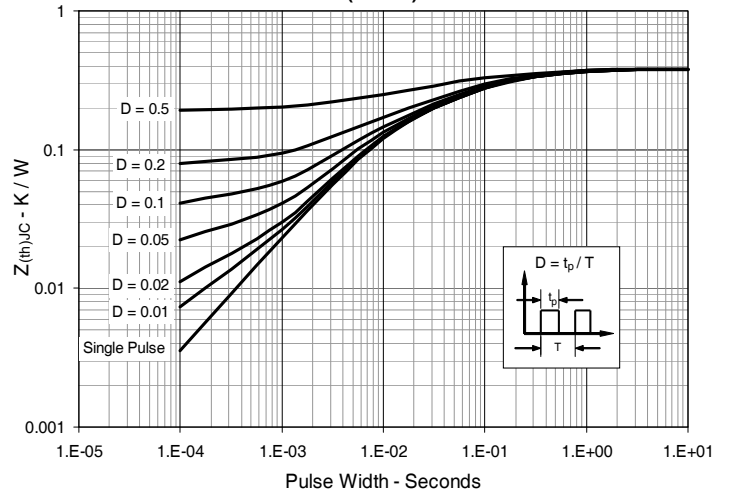
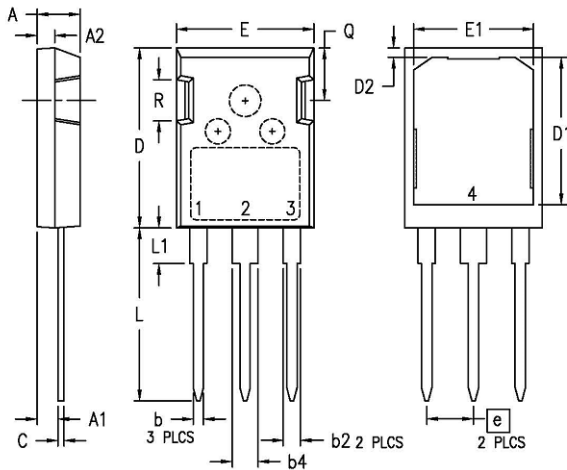

Fig. 26. Maximum Transient Thermal Impedance (Diode)



PLUS247 Outline

SYM	INCHES		MILLIMETERS	
	MIN	MAX	MIN	MAX
A	.190	.205	4.83	5.21
A1	.090	.100	2.29	2.54
A2	.075	.085	1.91	2.16
b	.045	.055	1.14	1.40
b2	.075	.087	1.91	2.20
b4	.115	.126	2.92	3.20
C	.024	.031	0.61	0.80
D	.819	.840	20.80	21.34
D1	.650	.690	16.51	17.53
D2	.035	.050	0.89	1.27
E	.620	.635	15.75	16.13
E1	.520	.560	13.08	14.22
e	.215 BSC		5.45 BSC	
L	.780	.810	19.81	20.57
L1	.150	.170	3.81	4.32
Q	.220	.244	5.59	6.20
R	.170	.190	4.32	4.83

PINS:
 1 - Gate
 2,4 - Collector
 3 - Emitter

NOTE: 1. This drawing will meet all dimensions requirement of JEDEC outline TO-247 AD (R-PSIP-F3) except screw mounting hole.
 2. Pin #2 is connected to the bottom heatsink (#4).
 3. Lead finish - One of the following depending on the packaging plants.
 3.1 Matte pure tin plating on the leads and back heatsink.
 3.2 Pb free solder dip on the leads and pre Ni plated back heatsink.

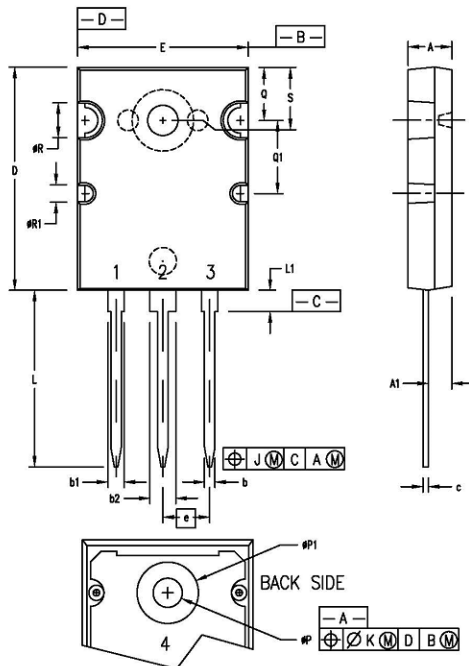
TO-264 Outline

SYMBOL	INCHES		MILLIMETERS	
	MIN	MAX	MIN	MAX
A	.185	.209	4.70	5.31
A1	.102	.118	2.59	3.00
b	.037	.055	0.94	1.40
b1	.087	.102	2.21	2.59
b2	.110	.126	2.79	3.20
c	.017	.029	0.43	0.74
D	1.007	1.047	25.58	26.59
E	.760	.799	19.30	20.29
e	.215BSC		5.46 BSC	
J	.000	.010	0.00	0.25
K	.000	.010	0.00	0.25
L	.779	.842	19.79	21.39
L1	.087	.102	2.21	2.59
ØP	.122	.138	3.10	3.51
ØP1	.270	.290	6.86	7.37
Q	.240	.256	6.10	6.50
Q1	.330	.346	8.38	8.79
ØR	.155	.187	3.94	4.75
ØR1	.085	.093	2.16	2.36
S	.243	.253	6.17	6.43

PINS:
 1 - Gate 2,4 - Collector
 3 - Emitter

NOTE:
 1. This drawing meets all dimensions requirement of JEDEC outlines TO-264AA.
 2. Back heatsink is pre-Ni plated Cu.
 3. Leads are Lead free solder dip unless specified as matte pure tin plating.



Disclaimer Notice - Information furnished is believed to be accurate and reliable. However, users should independently evaluate the suitability of and test each product selected for their own applications. Littelfuse products are not designed for, and may not be used in, all applications. Read complete Disclaimer Notice at www.littelfuse.com/disclaimer-electronics.
