

# High Voltage IGBT w/ Diode

## IXGH28N120BD1 IXGT28N120BD1

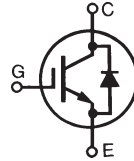

$V_{CES} = 1200V$   
 $I_{C25} = 50A$   
 $V_{CE(sat)} \leq 3.5V$   
 $t_{fi(typ)} = 170ns$

Symbol	Test Conditions	Maximum Ratings	
$V_{CES}$	$T_J = 25^\circ C$ to $150^\circ C$	1200	V
$V_{CGR}$	$T_J = 25^\circ C$ to $150^\circ C$ , $R_{GE} = 1M\Omega$	1200	V
$V_{GES}$	Continuous	$\pm 20$	V
$V_{GEM}$	Transient	$\pm 30$	V
$I_{C25}$	$T_C = 25^\circ C$ ( Chip Capability )	50	A
$I_{C100}$	$T_C = 100^\circ C$	28	A
$I_{F90}$	$T_C = 90^\circ C$	10	A
$I_{CM}$	$T_C = 25^\circ C$ , 1ms	150	A
<b>SSOA</b>	$V_{GE} = 15V$ , $T_J = 125^\circ C$ , $R_G = 5\Omega$	$I_{CM} = 120$	A
<b>(RBSOA)</b>	Clamped Inductive Load	$0.8 \cdot V_{CES}$	
$P_C$	$T_C = 25^\circ C$	250	W
$T_J$		-55 ... +150	$^\circ C$
$T_{JM}$		150	$^\circ C$
$T_{stg}$		-55 ... +150	$^\circ C$
$T_L$	Maximum Lead Temperature for Soldering	300	$^\circ C$
$T_{SOLD}$	1.6 mm (0.062 in.) from Case for 10	260	$^\circ C$
$M_d$	Mounting Torque (TO-247)	1.13/10	Nm/lb.in.
<b>Weight</b>	TO-247	6	g
	TO-286	4	g

TO-247AD (IXGH)

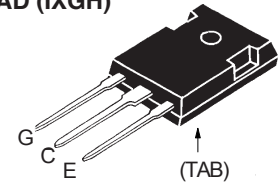

TO-268 (IXGT)

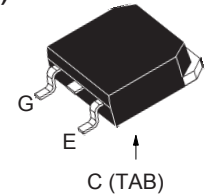

G = Gate      C = Collector  
 E = Emitter    TAB = Collector

### Features

- International Standard Packages JEDEC TO-247AD & TO-268
- IGBT and Anti-Parallel FRED for Resonant Power Supplies
  - Induction Heating
  - Rice Cookers
- MOS Gate Turn-On
- Fast Recovery Expitaxial Diode (FRED)
  - Soft Recovery with Low  $I_{RM}$

### Advantages

- Saves Space (Two Devices in One Package)
- Easy to Mount with 1 Screw (Isolated Mounting Screw Hole)
- Reduces Assembly Time and Cost

### Applications

- Switch-Mode and Resonant-Mode Power Supplies
- Uninterruptible Power Supplies (UPS)
- DC Choppers
- AC Motor Speed Drives
- DC Servo and Robot Drives

Symbol	Test Conditions ( $T_J = 25^\circ C$ , Unless Otherwise Specified)	Characteristic Values		
		Min.	Typ.	Max.
$V_{GE(th)}$	$I_C = 250\mu A$ , $V_{CE} = V_{GE}$	2.5		5.0 V
$I_{CES}$	$V_{CE} = V_{CES}$ , $V_{GE} = 0V$ $T_J = 125^\circ C$ , Note1			50 $\mu A$ 250 $\mu A$
$I_{GES}$	$V_{CE} = 0V$ , $V_{GE} = \pm 20V$			$\pm 100$ nA
$V_{CE(sat)}$	$I_C = 28A$ , $V_{GE} = 15V$ , Note 2 $T_J = 125^\circ C$	2.9		3.5 V
		2.8		V

Symbol	Test Conditions ( $T_J = 25^\circ\text{C}$ , Unless Otherwise Specified)	Characteristic Values		
		Min.	Typ.	Max.
$g_{fs}$	$I_C = 28\text{A}$ , $V_{CE} = 10\text{V}$ , Note 2	15	23	S
$C_{ies}$	$V_{CE} = 25\text{V}$ , $V_{GE} = 0\text{V}$ , $f = 1\text{MHz}$		1700	pF
$C_{oes}$			130	pF
$C_{res}$			45	pF
$Q_g$	$I_C = 28\text{A}$ , $V_{GE} = 15\text{V}$ , $V_{CE} = 0.5 \cdot V_{CES}$		92	nC
$Q_{ge}$			13	nC
$Q_{gc}$			35	nC
$t_{d(on)}$	<b>Inductive load, <math>T_J = 25^\circ\text{C}</math></b>		30	ns
$t_{ri}$		$I_C = 28\text{A}$ , $V_{GE} = 15\text{V}$	20	ns
$t_{d(off)}$	$V_{CE} = 0.8 \cdot V_{CES}$ , $R_G = 5\Omega$ Note 3		210	ns
$t_{fi}$			170	ns
$E_{off}$			2.2	5.0
$t_{d(on)}$	<b>Inductive load, <math>T_J = 125^\circ\text{C}</math></b>		35	ns
$t_{ri}$		$I_C = 28\text{A}$ , $V_{GE} = 15\text{V}$	28	ns
$E_{on}$	$V_{CE} = 0.8 \cdot V_{CES}$ , $R_G = 5\Omega$ Note 3		1.4	mJ
$t_{d(off)}$			250	ns
$t_{fi}$			340	ns
$E_{off}$			4.6	mJ
$R_{thJC}$	(TO-247)			0.50 $^\circ\text{C/W}$
$R_{thCK}$			0.21	$^\circ\text{C/W}$

### TO-247 (IXGH) Outline

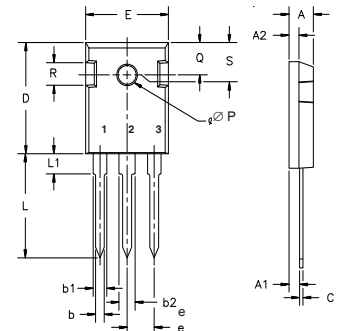

Terminals: 1 - Gate  
2 - Drain  
3 - Source

Dim.	Millimeter		Inches	
	Min.	Max.	Min.	Max.
A	4.7	5.3	.185	.209
A <sub>1</sub>	2.2	2.54	.087	.102
A <sub>2</sub>	2.2	2.6	.059	.098
b	1.0	1.4	.040	.055
b <sub>1</sub>	1.65	2.13	.065	.084
b <sub>2</sub>	2.87	3.12	.113	.123
C	.4	.8	.016	.031
D	20.80	21.46	.819	.845
E	15.75	16.26	.610	.640
e	5.20	5.72	0.205	0.225
L	19.81	20.32	.780	.800
L <sub>1</sub>		4.50		.177
∅P	3.55	3.65	.140	.144
Q	5.89	6.40	0.232	0.252
R	4.32	5.49	.170	.216
S	6.15	BSC	242	BSC

### Reverse Diode (FRED)

Symbol	Test Conditions ( $T_J = 25^\circ\text{C}$ , Unless Otherwise Specified)	Characteristic Values		
		Min.	Typ.	Max.
$V_F$	$I_F = 10\text{A}$ , $V_{GE} = 0\text{V}$ , Note 2 $T_J = 100^\circ\text{C}$		2.3	3.2 V
$I_{RM}$	$I_F = 10\text{A}$ , $V_{GE} = 0\text{V}$ , $-di_F/dt = 400\text{A}/\mu\text{s}$ , $V_R = 600\text{V}$		14	A
$t_{rr}$			120	ns
$t_{rr}$	$I_F = 1\text{A}$ , $V_{GE} = 0\text{V}$ , $-di_F/dt = 100\text{A}/\mu\text{s}$ , $V_R = 30\text{V}$		40	ns
$R_{thJC}$				2.5 $^\circ\text{C/W}$

### Notes:

- Part must be heatsunk for high-temp  $I_{CES}$  measurement.
- Pulse test,  $t \leq 300\mu\text{s}$ , duty cycle,  $d \leq 2\%$ .
- Switching times & energy losses may increase for higher  $V_{CE}$  (Clamp),  $T_J$  or  $R_G$ .

### TO-268 (IXGT) Outline

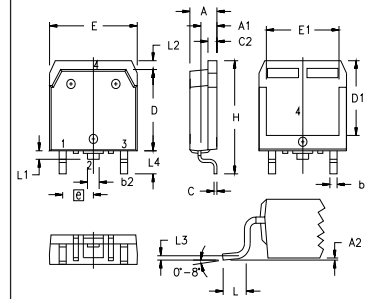

SYM	INCHES		MILLIMETERS	
	MIN	MAX	MIN	MAX
A	.193	.201	4.90	5.10
A <sub>1</sub>	.106	.114	2.70	2.90
A <sub>2</sub>	.001	.010	0.02	0.25
b	.045	.057	1.15	1.45
b <sub>2</sub>	.075	.083	1.90	2.10
C	.016	.026	0.40	0.65
C <sub>2</sub>	.057	.063	1.45	1.60
D	.543	.551	13.80	14.00
D <sub>1</sub>	.488	.500	12.40	12.70
E	.624	.632	15.85	16.05
E <sub>1</sub>	.524	.535	13.30	13.60
e	.215 BSC		5.45 BSC	
H	.736	.752	18.70	19.10
L	.094	.106	2.40	2.70
L <sub>1</sub>	.047	.055	1.20	1.40
L <sub>2</sub>	.039	.045	1.00	1.15
L <sub>3</sub>	.010 BSC		0.25 BSC	
L <sub>4</sub>	.150	.161	3.80	4.10

IXYS reserves the right to change limits, test conditions and dimensions.

IXYS MOSFETs and IGBTs are covered by one or more of the following U.S. patents:	4,835,592	4,931,844	5,049,961	5,237,481	6,162,665	6,404,065 B1	6,683,344	6,727,585	7,005,734 B2	7,157,338B2
	4,850,072	5,017,508	5,063,307	5,381,025	6,259,123 B1	6,534,343	6,710,405 B2	6,759,692	7,063,975 B2	
	4,881,106	5,034,796	5,187,117	5,486,715	6,306,728 B1	6,583,505	6,710,463	6,771,478 B2	7,071,537	

**Fig. 1. Output Characteristics @ 25 °C**

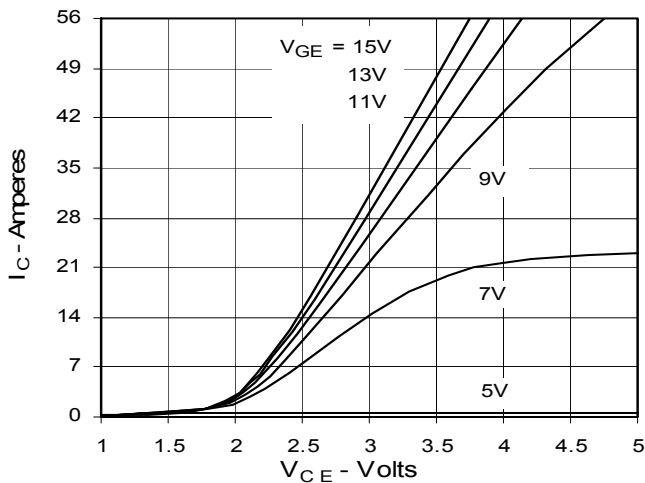

**Fig. 2. Extended Output Characteristics @ 25 °C**

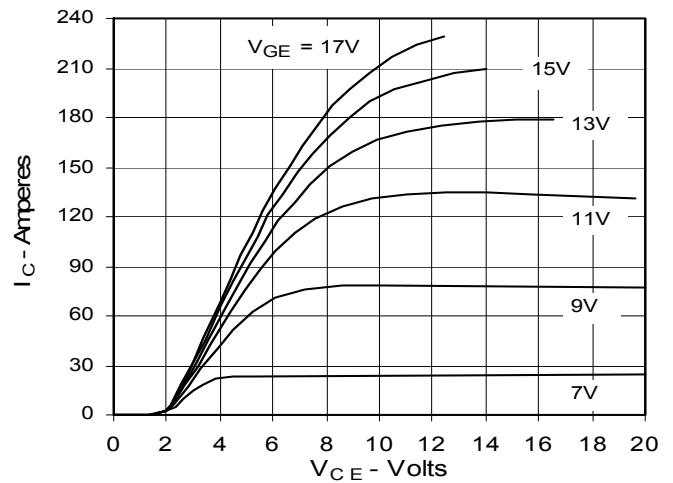

**Fig. 3. Output Characteristics @ 125 °C**

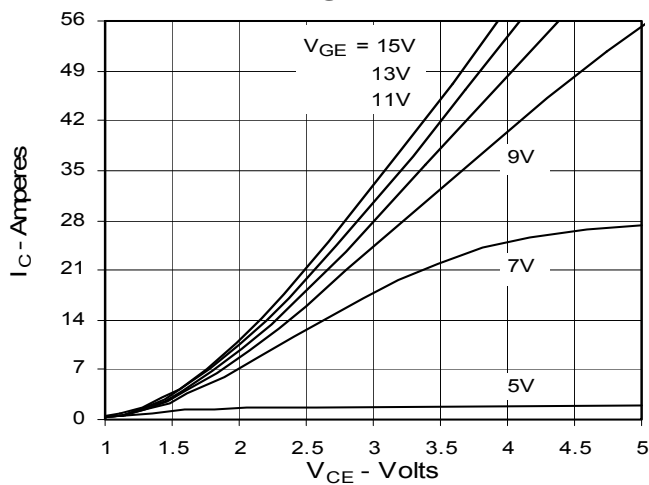

**Fig. 4. Dependence of  $V_{CE(sat)}$  on Temperature**

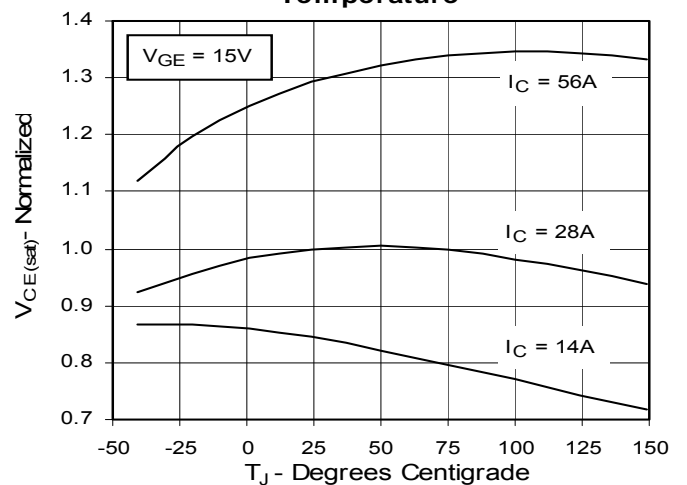

**Fig. 5. Collector-to-Emitter Voltage vs. Gate-to-Emitter voltage**

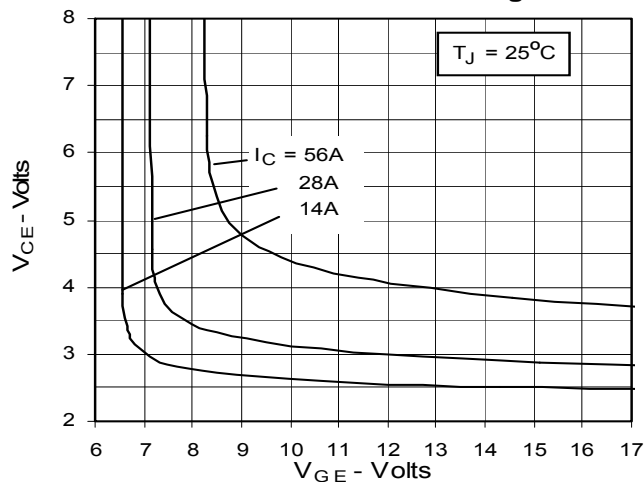

**Fig. 6. Input Admittance**

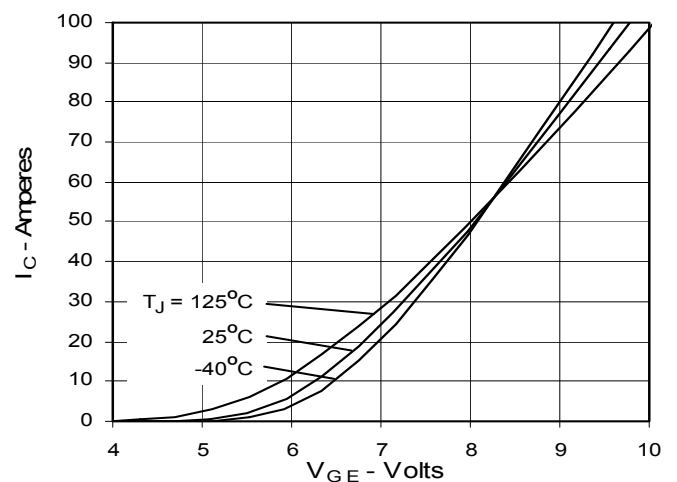

**Fig. 7. Transconductance**

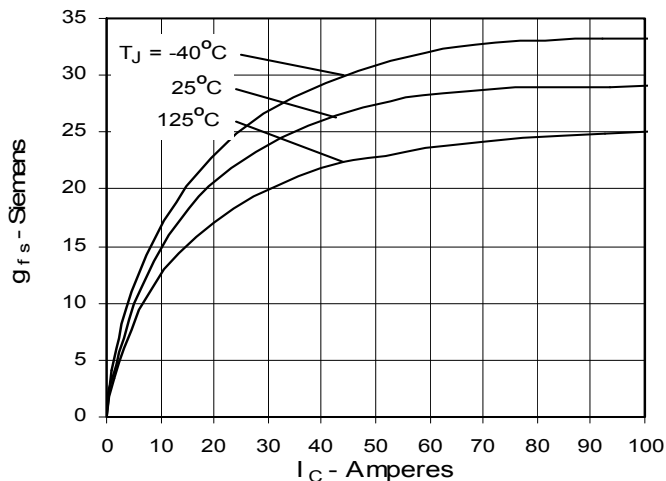

**Fig. 8. Dependence of Turn-off Energy Loss on  $R_G$**

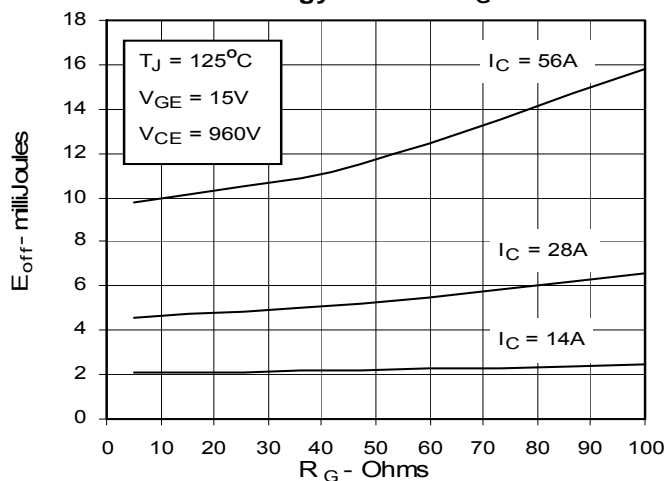

**Fig. 9. Dependence of Turn-Off Energy Loss on  $I_C$**

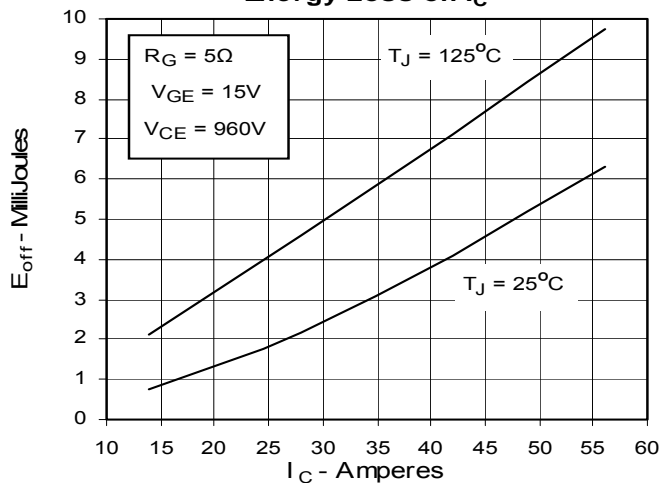

**Fig. 10. Dependence of Turn-off Energy Loss on Temperature**

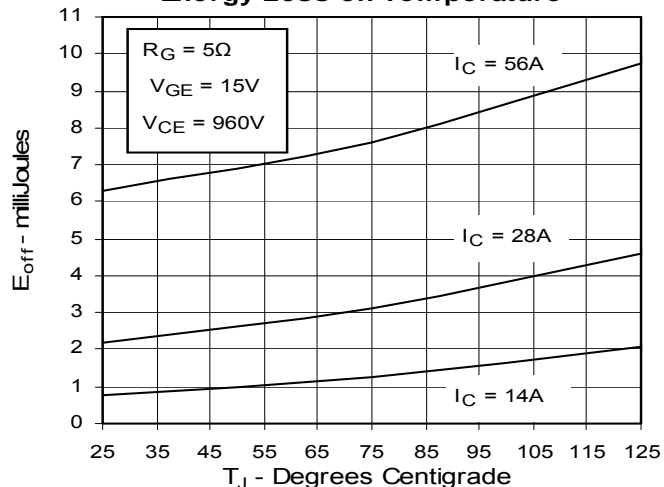

**Fig. 11. Dependence of Turn-off Switching Time on  $R_G$**

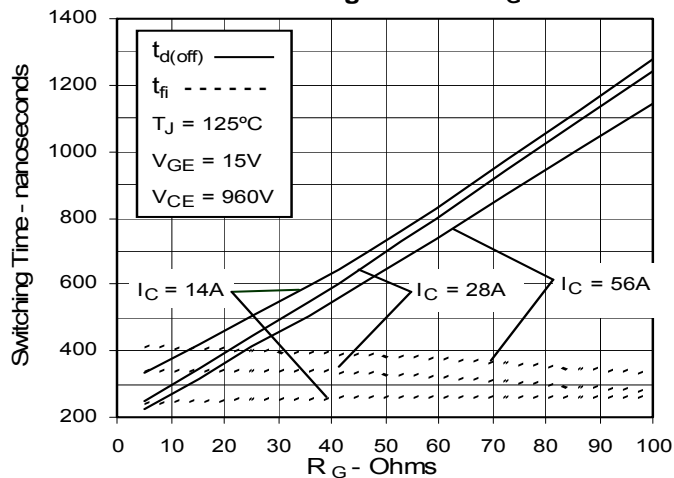

**Fig. 12. Dependence of Turn-off Switching Time on  $I_C$**

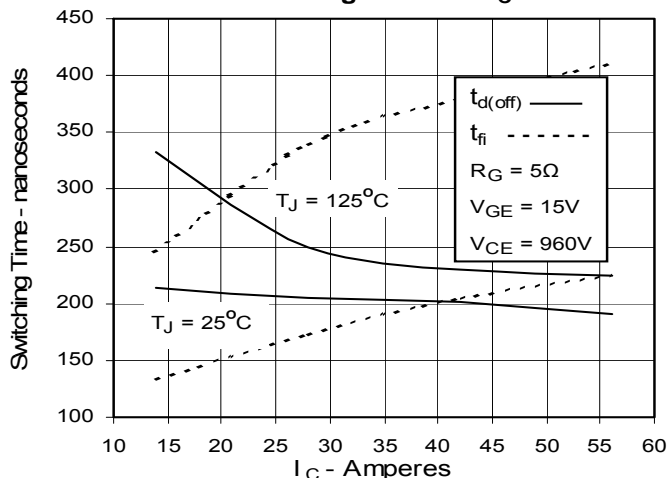

**Fig. 13. Dependence of Turn-off Switching Time on Temperature**

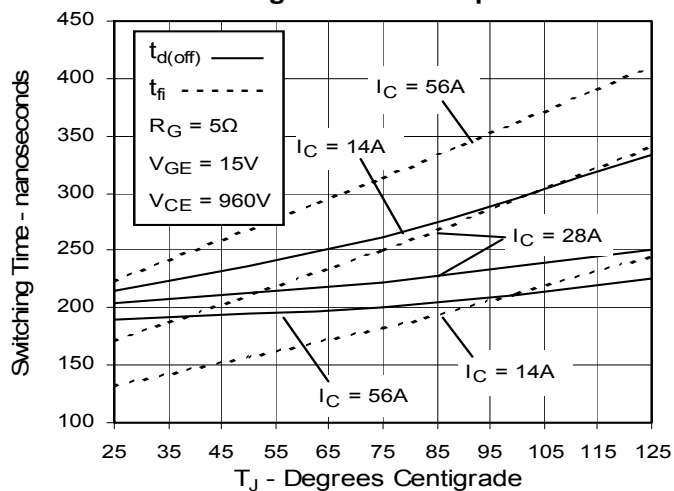

**Fig. 14. Gate Charge**

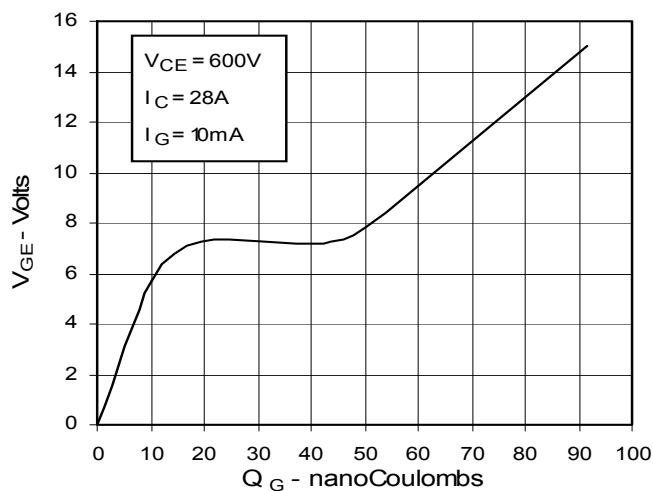

**Fig. 15. Capacitance**

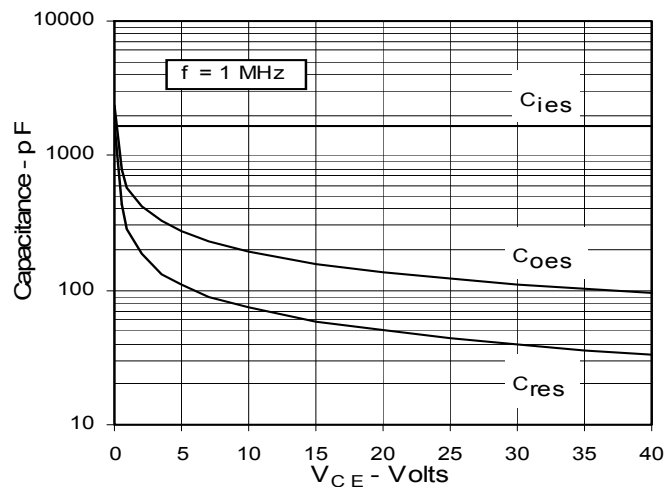

**Fig. 16. Reverse-Bias Safe Operating Area**

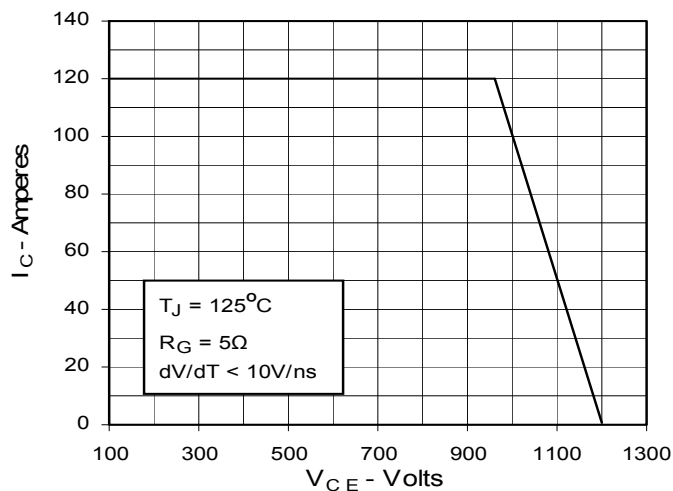

**Fig. 17. Maximum Transient Thermal Resistance**

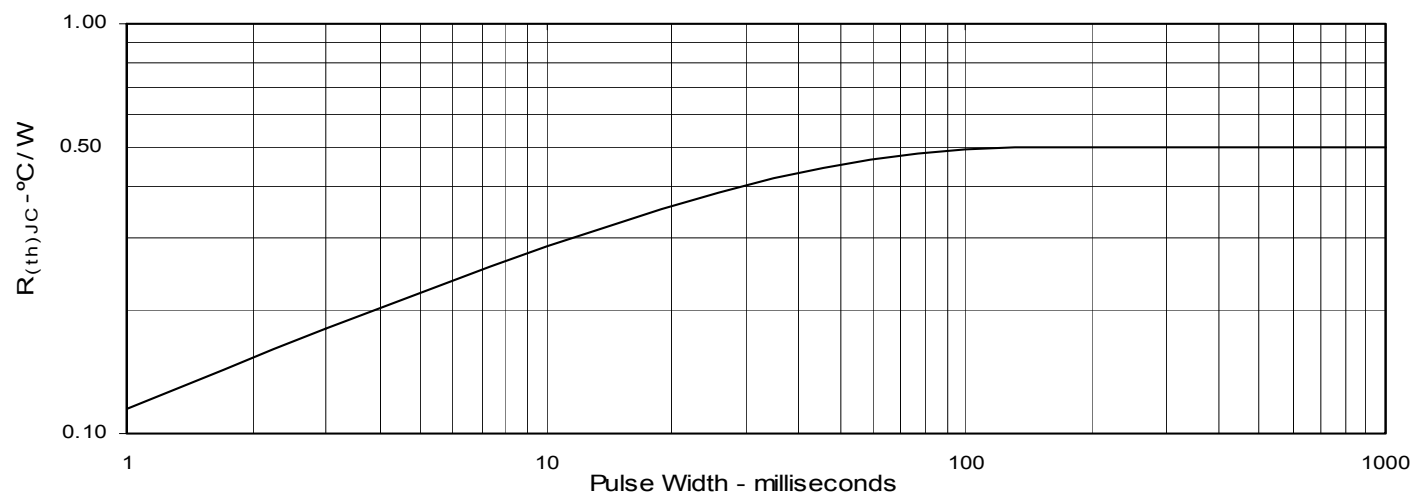

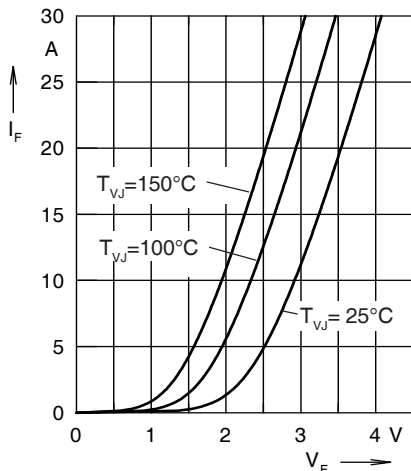

Fig. 18. Forward current  $I_F$  versus  $V_F$

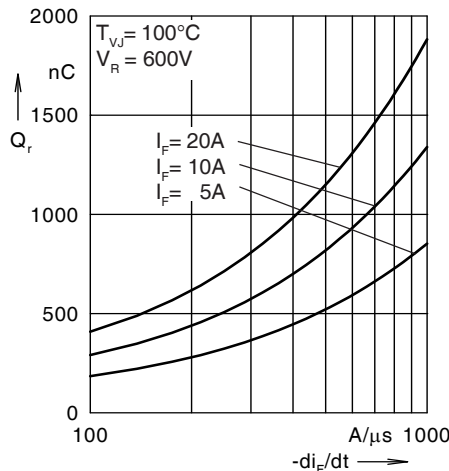

Fig. 19. Reverse recovery charge  $Q_r$  versus  $-di_F/dt$

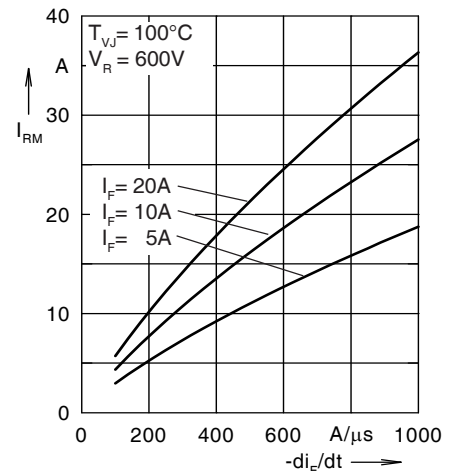

Fig. 20. Peak reverse current  $I_{RM}$  versus  $-di_F/dt$

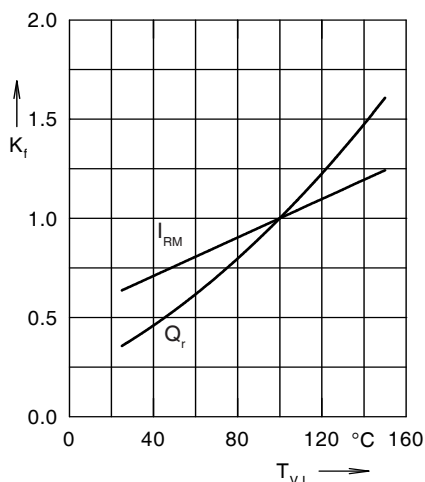

Fig. 21. Dynamic parameters  $Q_r$ ,  $I_{RM}$  versus  $T_{VJ}$

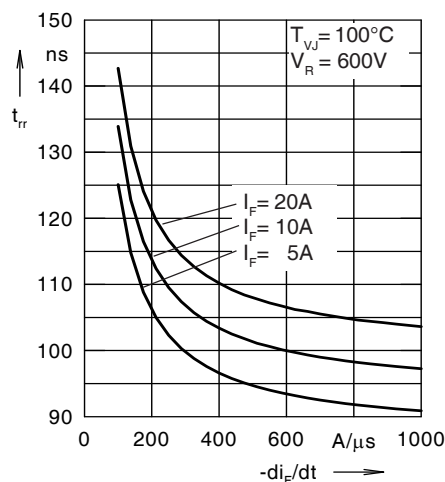

Fig. 22. Recovery time  $t_{rr}$  versus  $-di_F/dt$

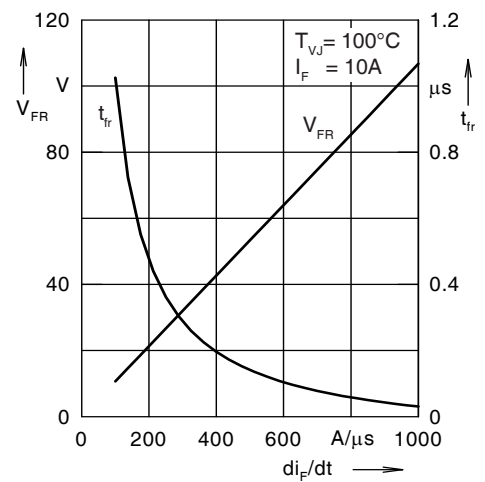

Fig. 23. Peak forward voltage  $V_{FR}$  and  $t_{tr}$  versus  $di_F/dt$

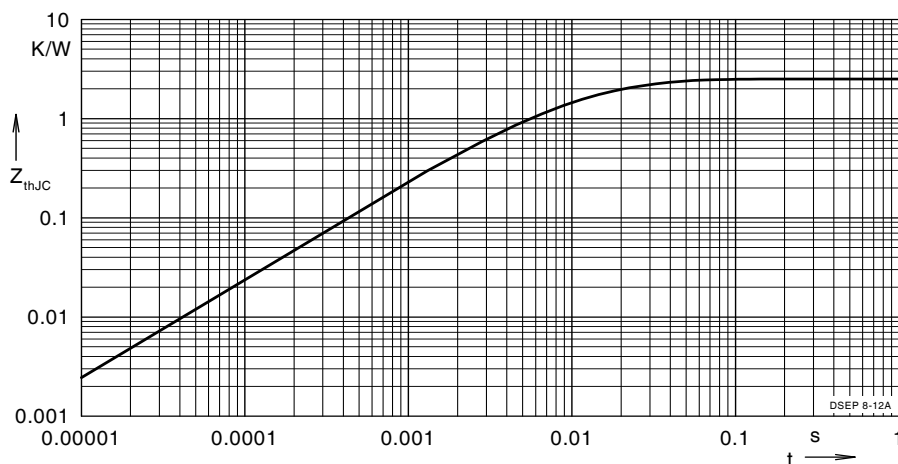

Fig. 24. Transient thermal resistance junction to case

Constants for  $Z_{thJC}$  calculation:

i	$R_{thi}$ (K/W)	$t_i$ (s)
1	1.449	0.0052
2	0.558	0.0003
3	0.493	0.017



---

Disclaimer Notice - Information furnished is believed to be accurate and reliable. However, users should independently evaluate the suitability of and test each product selected for their own applications. Littelfuse products are not designed for, and may not be used in, all applications. Read complete Disclaimer Notice at [www.littelfuse.com/disclaimer-electronics](http://www.littelfuse.com/disclaimer-electronics).