

HiPerFAST™ IGBT with Diode

C2-Class High Speed IGBTs

IXGK 60N60C2D1
IXGX 60N60C2D1

V_{CES} = 600 V
I_{C25} = 75 A
V_{CE(sat)} = 2.5 V
t_{fi(typ)} = 35 ns

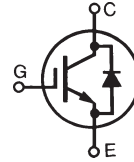

Symbol	Test Conditions	Maximum Ratings	
V _{CES}	T _J = 25°C to 150°C	600	V
V _{CGR}	T _J = 25°C to 150°C; R _{GE} = 1 MΩ	600	V
V _{GES}	Continuous	±20	V
V _{GEM}	Transient	±30	V
I _{C25}	T _C = 25°C (limited by leads)	75	A
I _{C110}	T _C = 110°C	60	A
I _{F110}	T _C = 110°C	48	A
I _{CM}	T _C = 25°C, 1 ms	300	A
SSOA (RBSOA)	V _{GE} = 15 V, T _{vj} = 125°C, R _G = 10 Ω Clamped inductive load @ V _{CE} ≤ 600 V	I _{CM} = 100	A
P _C	T _C = 25°C	480	W
T _J		-55 ... +150	°C
T _{JM}		150	°C
T _{stg}		-55 ... +150	°C
M _d	Mounting torque, TO-264	1.13/10	Nm/lb.in.
Weight	TO-264	10	g
	PLUS247	6	g
Maximum lead temperature for soldering 1.6 mm (0.062 in.) from case for 10 s		300	°C

**TO-264 AA
(IXGK)**

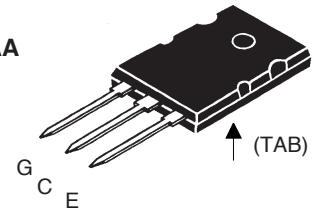

**PLUS247
(IXGX)**

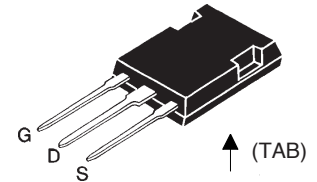

G = Gate C = Collector
E = Emitter Tab = Collector

Features

- Very high frequency IGBT and anti-parallel FRED in one package
- Square RBSOA
- High current handling capability
- MOS Gate turn-on for drive simplicity
- Fast Recovery Epitaxial Diode (FRED) with soft recovery and low I_{RM}

Applications

- Switch-mode and resonant-mode power supplies
- Uninterruptible power supplies (UPS)
- DC choppers
- AC motor speed control
- DC servo and robot drives

Advantages

- Space savings (two devices in one package)
- Easy to mount with 1 screw

Symbol	Test Conditions	Characteristic Values (T _J = 25°C unless otherwise specified)		
		Min.	Typ.	Max.
V _{GE(th)}	I _C = 250 μA, V _{CE} = V _{GE}	3.0		5.0 V
I _{CES}	V _{CE} = V _{CES} V _{GE} = 0 V	T _J = 25°C		650 μA
		T _J = 125°C		5 mA
I _{GES}	V _{CE} = 0 V, V _{GE} = ±20 V			±100 nA
V _{CE(sat)}	I _C = 50 A, V _{GE} = 15 V Note 1	T _J = 25°C		2.1 V
		T _J = 125°C		1.8 V

Symbol	Test Conditions	Characteristic Values		
		Min.	Typ.	Max.
g_{fs}	$I_C = 50 \text{ A}; V_{CE} = 10 \text{ V}$, Note 1	40	58	S
C_{ies}	$V_{CE} = 25 \text{ V}, V_{GE} = 0 \text{ V}, f = 1 \text{ MHz}$		3900	pF
C_{oes}		280	pF	
C_{res}		97	pF	
Q_g	$I_C = 50 \text{ A}, V_{GE} = 15 \text{ V}, V_{CE} = 0.5 V_{CES}$		146	nC
Q_{ge}		28	nC	
Q_{gc}		50	nC	
$t_{d(on)}$	Inductive load, $T_J = 25^\circ\text{C}$ $I_C = 50 \text{ A}, V_{GE} = 15 \text{ V}$ $V_{CE} = 400 \text{ V}, R_G = R_{off} = 2.0 \Omega$		18	ns
E_{on}		0.4	mJ	
t_{ri}		25	ns	
$t_{d(off)}$		95	150	ns
t_{fi}		35	ns	
E_{off}	0.48	0.8	mJ	
$t_{d(on)}$	Inductive load, $T_J = 125^\circ\text{C}$ $I_C = 50 \text{ A}, V_{GE} = 15 \text{ V}$ $V_{CE} = 400 \text{ V}, R_G = R_{off} = 2.0 \Omega$		18	ns
t_{ri}		25	ns	
E_{on}		0.9	mJ	
$t_{d(off)}$		130	ns	
t_{fi}		80	ns	
E_{off}	1.2	mJ		
R_{thJC}		0.15	0.26	K/W
R_{thCK}				K/W

Reverse Diode (FRED)

Symbol	Test Conditions	Characteristic Values		
		min.	typ.	max.
V_F	$I_F = 60 \text{ A}, V_{GE} = 0 \text{ V}$, Note 1			2.1 V
		$T_J = 150^\circ\text{C}$		1.4
I_{RM}	$I_F = 60 \text{ A}, V_{GE} = 0 \text{ V}, -di_F/dt = 100 \text{ A}/\mu\text{s}$ $V_R = 100 \text{ V}$			8.3 A
t_{rr}	$I_F = 1 \text{ A}; -di/dt = 200 \text{ A/ms}; V_R = 30 \text{ V}$	35		ns
R_{thJC}			0.65	K/W

Note 1: Pulse test, $t \leq 300 \mu\text{s}$, duty cycle $\leq 2\%$

IXYS reserves the right to change limits, test conditions, and dimensions.

IXYS MOSFETs and IGBTs are covered by 4,835,592 4,931,844 5,049,961 5,237,481 6,162,665 6,404,065 B1 6,683,344 6,727,585
 one or more of the following U.S. patents: 4,850,072 5,017,508 5,063,307 5,381,025 6,259,123 B1 6,534,343 6,710,405 B2 6,759,692
 4,881,106 5,034,796 5,187,117 5,486,715 6,306,728 B1 6,583,505 6,710,463 6771478 B2

TO-264 AA Outline

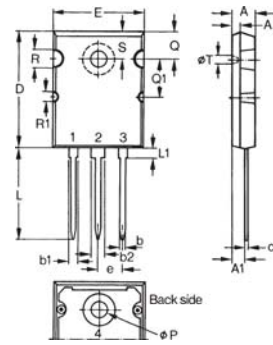

Dim.	Millimeter		Inches	
	Min.	Max.	Min.	Max.
A	4.82	5.13	.190	.202
A1	2.54	2.89	.100	.114
A2	2.00	2.10	.079	.083
b	1.12	1.42	.044	.056
b1	2.39	2.69	.094	.106
b2	2.90	3.09	.114	.122
c	0.53	0.83	.021	.033
D	25.91	26.16	1.020	1.030
E	19.81	19.96	.780	.786
e	5.46 BSC		.215 BSC	
J	0.00	0.25	.000	.010
K	0.00	0.25	.000	.010
L	20.32	20.83	.800	.820
L1	2.29	2.59	.090	.102
P	3.17	3.66	.125	.144
Q	6.07	6.27	.239	.247
Q1	8.38	8.69	.330	.342
R	3.81	4.32	.150	.170
R1	1.78	2.29	.070	.090
S	6.04	6.30	.238	.248
T	1.57	1.83	.062	.072

PLUS247 Outline

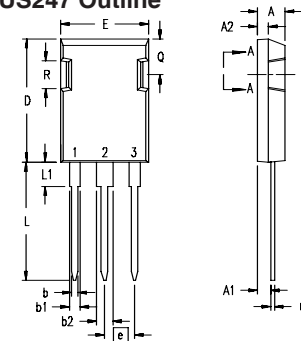

Terminals: 1 - Gate
 2 - Drain (Collector)
 3 - Source (Emitter)
 4 - Drain (Collector)

Dim.	Millimeter		Inches	
	Min.	Max.	Min.	Max.
A	4.83	5.21	.190	.205
A1	2.29	2.54	.090	.100
A2	1.91	2.16	.075	.085
b	1.14	1.40	.045	.055
b1	1.91	2.13	.075	.084
b2	2.92	3.12	.115	.123
C	0.61	0.80	.024	.031
D	20.80	21.34	.819	.840
E	15.75	16.13	.620	.635
e	5.45 BSC		.215 BSC	
L	19.81	20.32	.780	.800
L1	3.81	4.32	.150	.170
Q	5.59	6.20	.220	0.244
R	4.32	4.83	.170	.190

Fig. 1. Output Characteristics @ 25°C

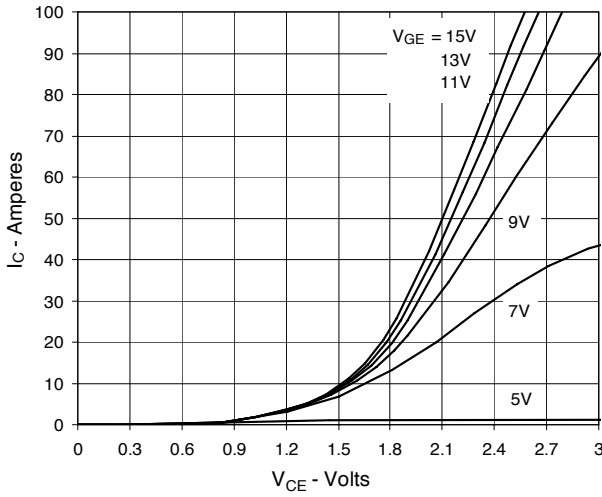

Fig. 2. Extended Output Characteristics @ 25°C

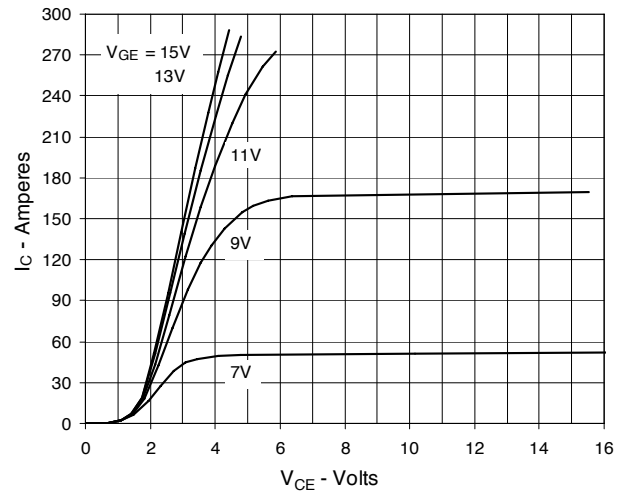

Fig. 3. Output Characteristics @ 125°C

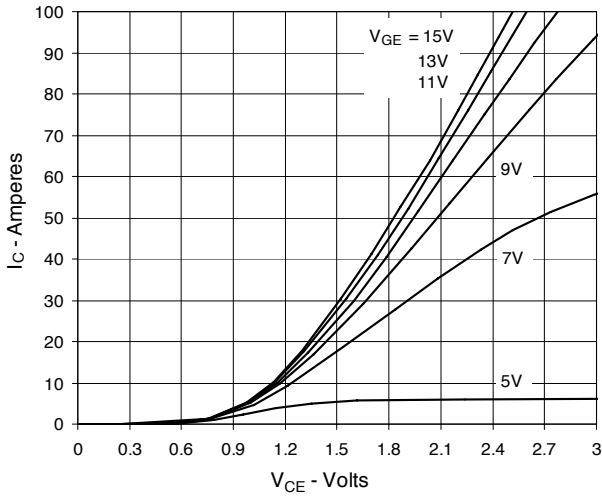

Fig. 4. Dependence of $V_{CE(sat)}$ on Junction Temperature

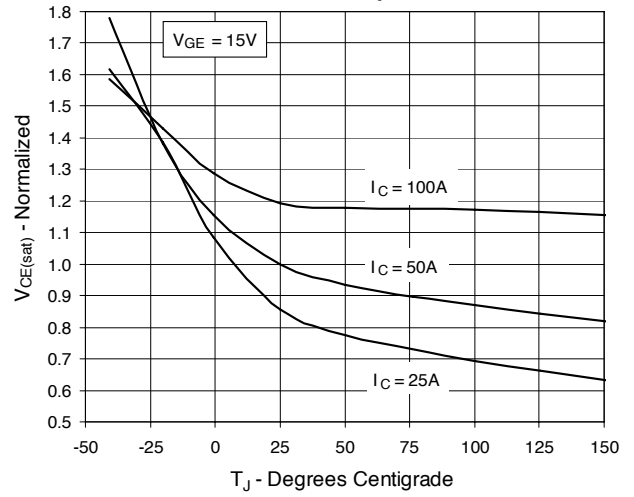

Fig. 5. Collector-to-Emitter Voltage vs. Gate-to-Emitter Voltage

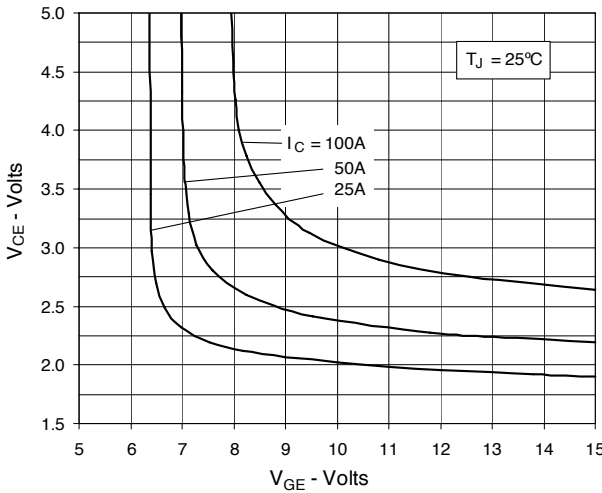

Fig. 6. Input Admittance

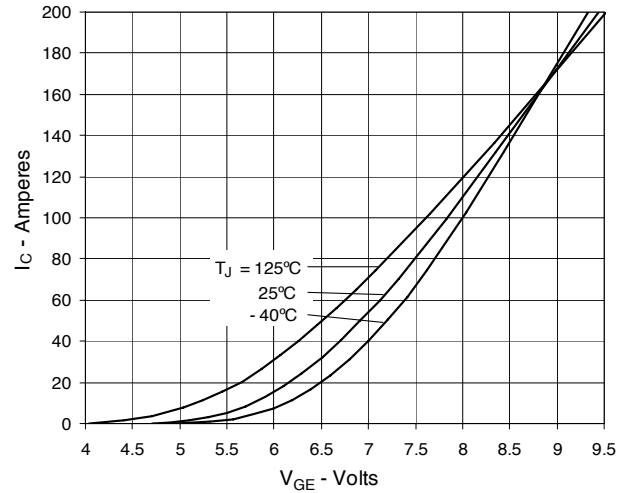

Fig. 7. Transconductance

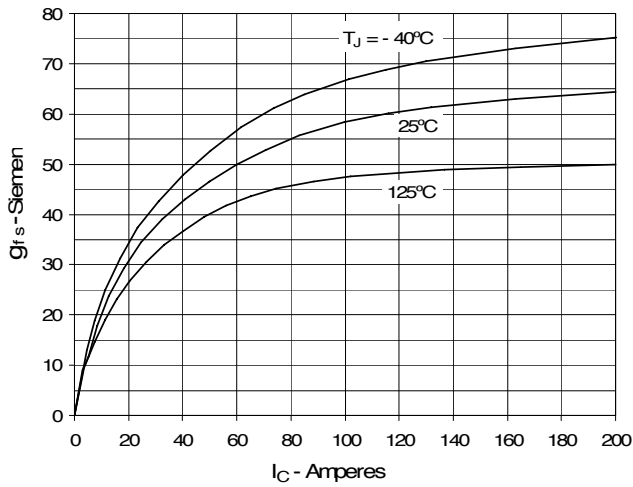

Fig. 8. Inductive Switching Energy Loss vs. Gate Resistance

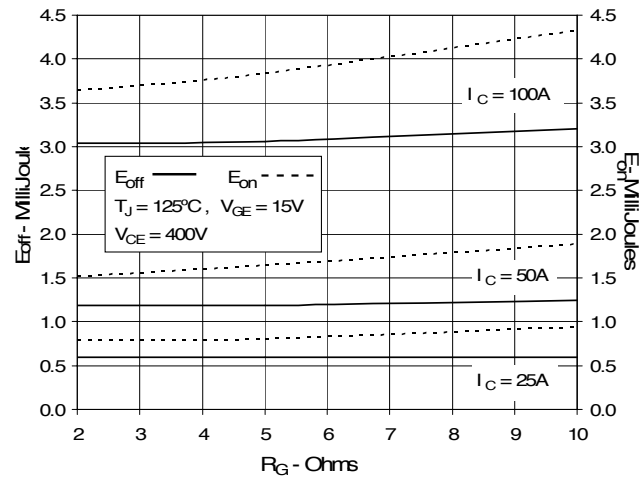

Fig. 9. Inductive Switching Energy Loss vs. Collector Current

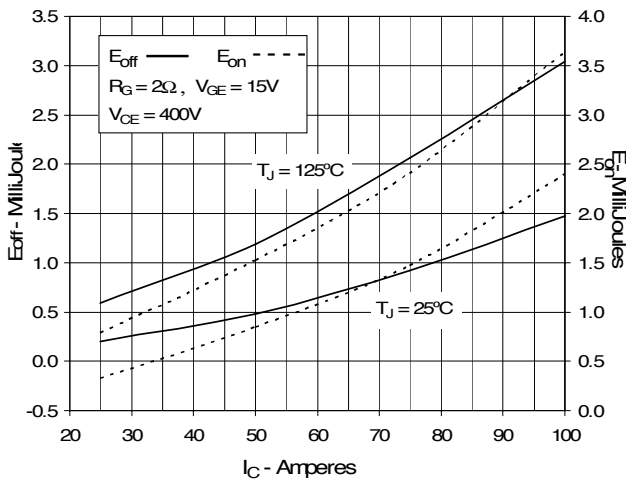

Fig. 10. Inductive Switching Energy Loss vs. Junction Temperature

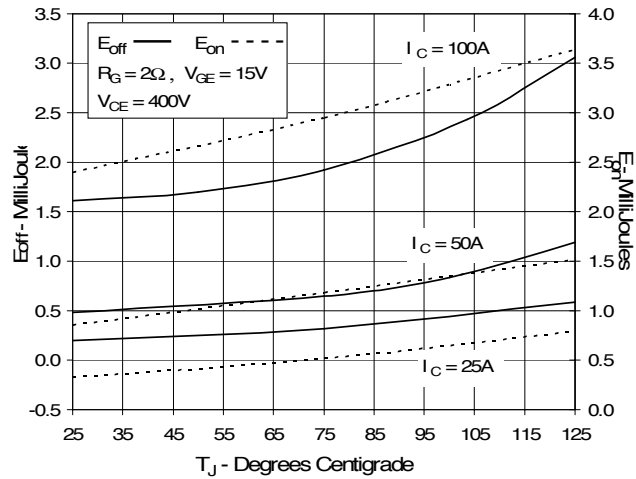

Fig. 11. Inductive Turn-off Switching Times vs. Gate Resistance

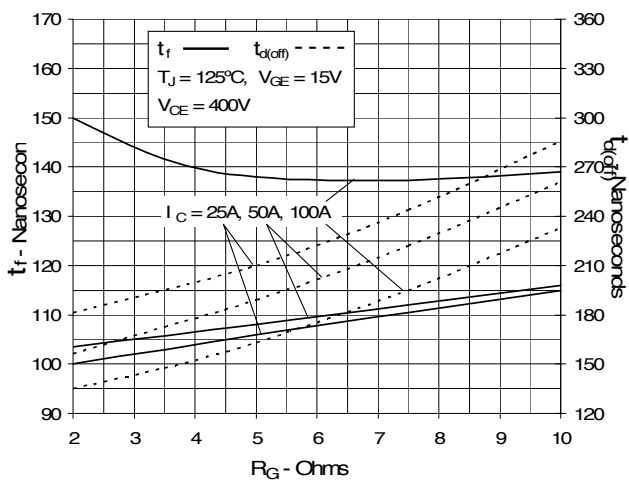
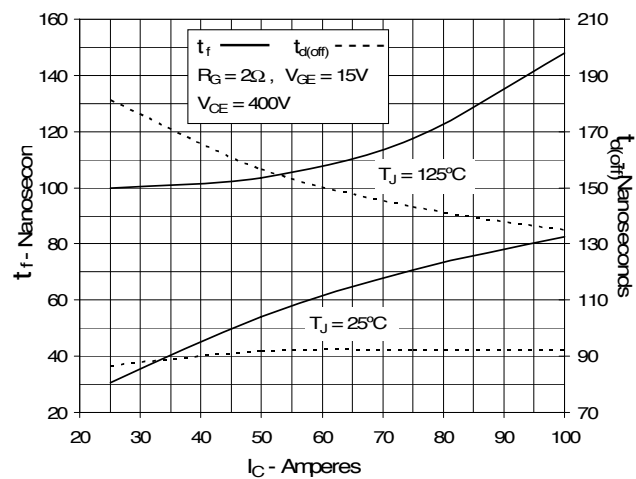
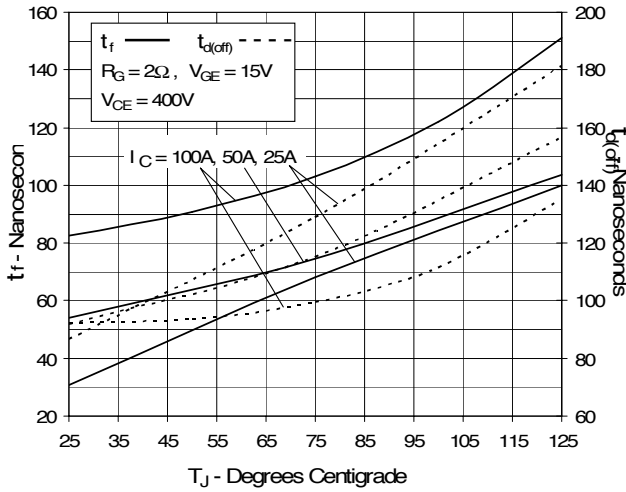

Fig. 12. Inductive Turn-off Switching Times vs. Collector Current



**Fig. 13. Inductive Turn-off
Switching Times vs. Junction Temperature**



**Fig. 14. Inductive Turn-on
Switching Times vs. Gate Resistance**

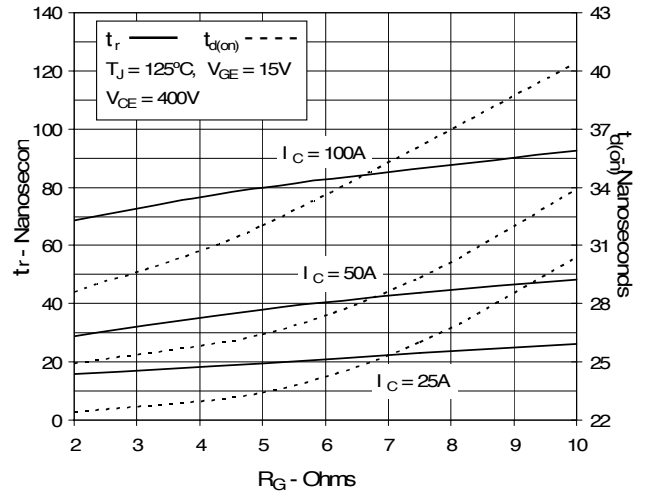

**Fig. 15. Inductive Turn-on
Switching Times vs. Collector Current**

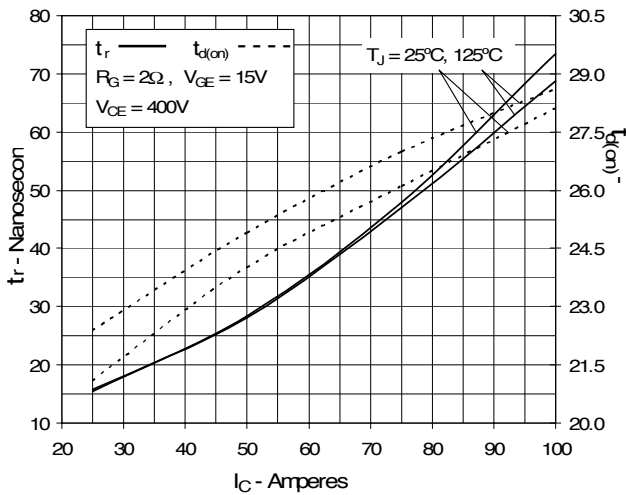

**Fig. 16. Inductive Turn-on
Switching Times vs. Junction Temperature**

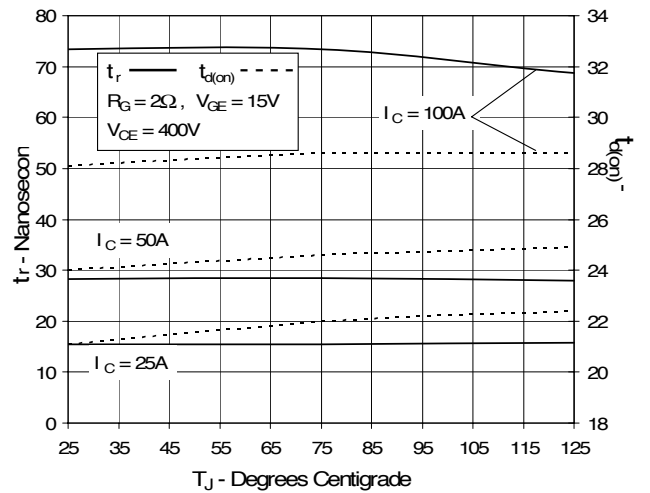

Fig. 17. Gate Charge

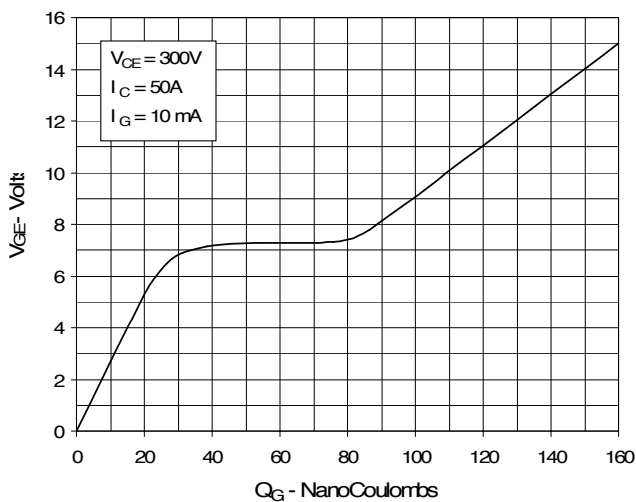

Fig. 18. Capacitance

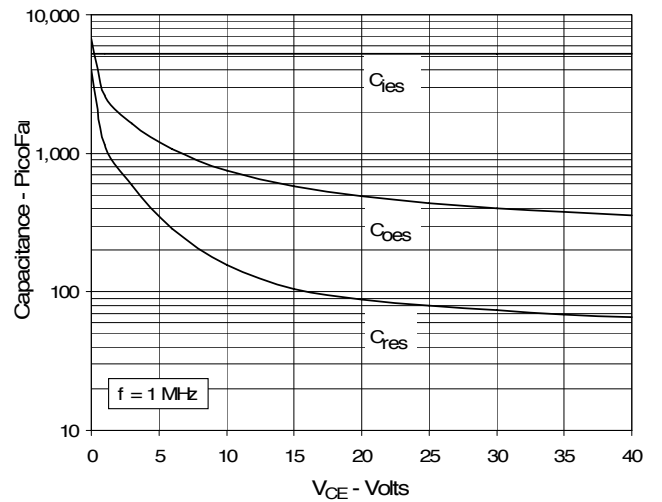

Fig. 19. Reverse-Bias Safe Operating Area

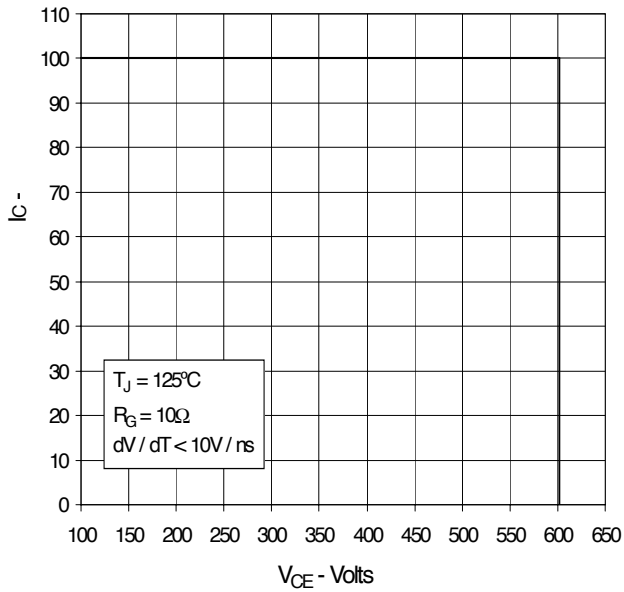
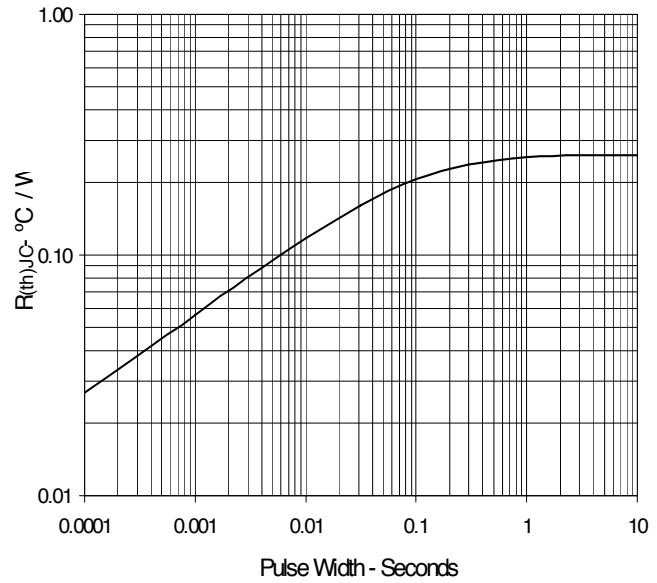

Fig. 20. Maximum Transient Thermal Resistance



Diode's Curves

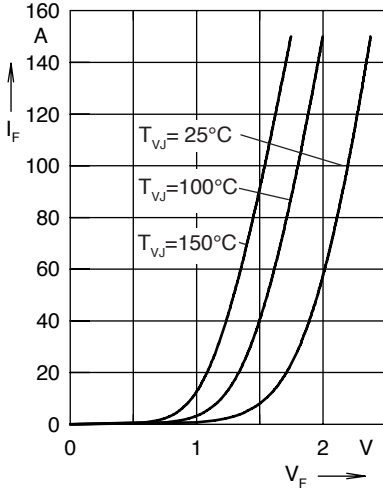

Fig. 21. Forward current I_F versus V_F

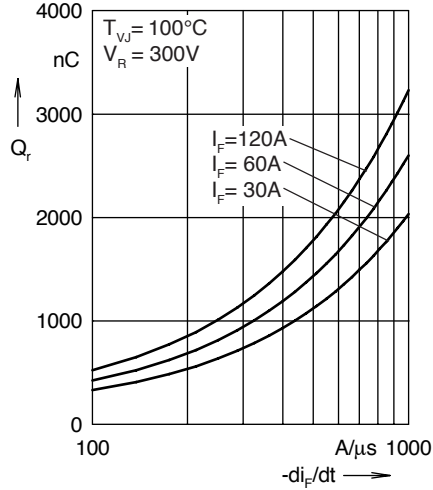

Fig. 22. Reverse recovery charge Q_r versus $-di_F/dt$

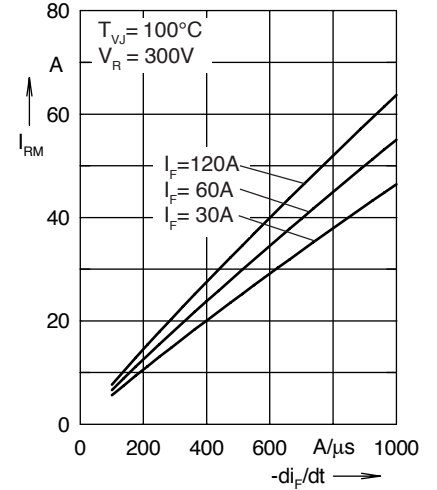

Fig. 23. Peak reverse current I_{RM} versus $-di_F/dt$

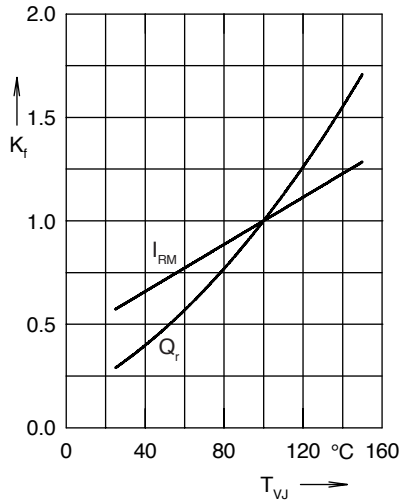

Fig. 24. Dynamic parameters Q_r , I_{RM} versus T_{VJ}

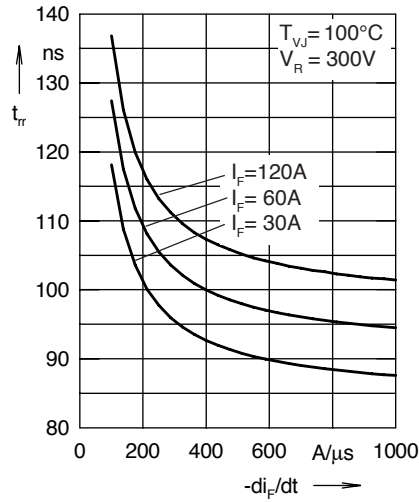

Fig. 25. Recovery time t_{rr} versus $-di_F/dt$

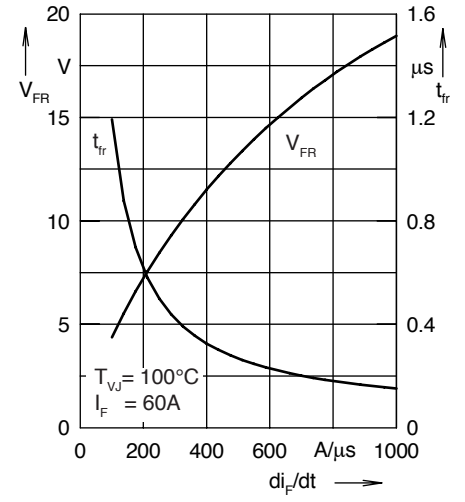

Fig. 26. Peak forward voltage V_{FR} and t_{fr} versus di_F/dt

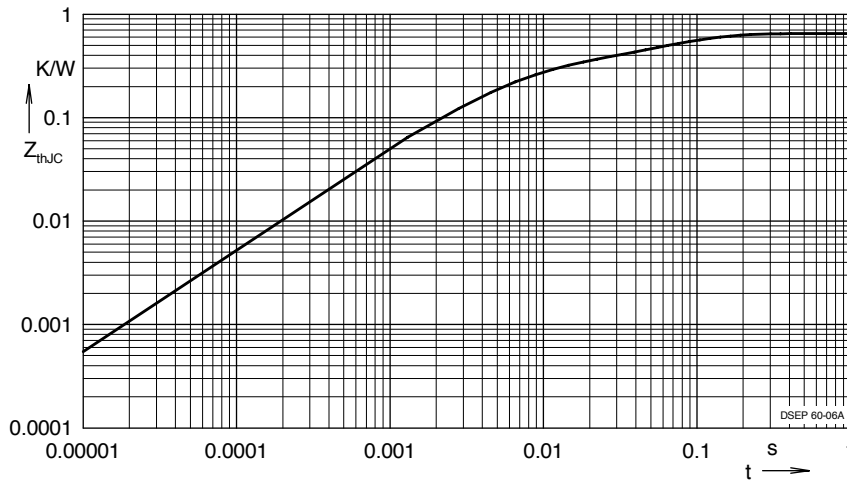

Fig. 27. Transient thermal resistance junction to case

Constants for Z_{thJC} calculation:

i	R_{thi} (K/W)	t_i (s)
1	0.324	0.0052
2	0.125	0.0003
3	0.201	0.0385

Note: Fig. 15 through Fig. 20 show typical values



Disclaimer Notice - Information furnished is believed to be accurate and reliable. However, users should independently evaluate the suitability of and test each product selected for their own applications. Littelfuse products are not designed for, and may not be used in, all applications. Read complete Disclaimer Notice at www.littelfuse.com/disclaimer-electronics.