

HiPerFAST™ IGBT

IXGH 30N60B2
IXGT 30N60B2

$V_{CES} = 600 \text{ V}$
 $I_{C25} = 70 \text{ A}$
 $V_{CE(sat)} < 1.8 \text{ V}$
 $t_{fi\text{typ}} = 82 \text{ ns}$

Optimized for 10-25 KHz hard switching and up to 150 KHz resonant switching

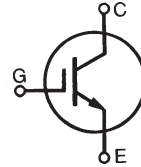

Symbol	Test Conditions	Maximum Ratings	
V_{CES}	$T_J = 25^\circ\text{C}$ to 150°C	600	V
V_{CGR}	$T_J = 25^\circ\text{C}$ to 150°C ; $R_{GE} = 1 \text{ M}\Omega$	600	V
V_{GES}	Continuous	± 20	V
V_{GEM}	Transient	± 30	V
I_{C25}	$T_C = 25^\circ\text{C}$ (limited by leads)	70	A
I_{C110}	$T_C = 110^\circ\text{C}$	30	A
I_{CM}	$T_C = 25^\circ\text{C}$, 1 ms	150	A
SSOA (RBSOA)	$V_{GE} = 15 \text{ V}$, $T_{VJ} = 125^\circ\text{C}$, $R_G = 10 \Omega$ Clamped inductive load @ $\leq 600 \text{ V}$	$I_{CM} = 60$	A
P_C	$T_C = 25^\circ\text{C}$	190	W
T_J		-55 ... +150	$^\circ\text{C}$
T_{JM}		150	$^\circ\text{C}$
T_{stg}		-55 ... +150	$^\circ\text{C}$
Maximum lead temperature for soldering 1.6 mm (0.062 in.) from case for 10 s		300	$^\circ\text{C}$
M_d	Mounting torque (M3)	1.13/10 Nm/lb.in.	
Weight	TO-247 AD	6	g
	TO-268 SMD	4	g

TO-268
(IXGT)

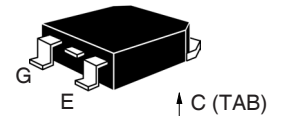

TO-247 AD
(IXGH)

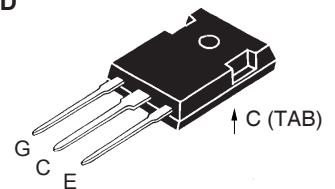

G = Gate, C = Collector,
E = Emitter, TAB = Collector

Features

- Medium frequency IGBT
- Square RBSOA
- High current handling capability
- MOS Gate turn-on - drive simplicity

Applications

- PFC circuits
- Uninterruptible power supplies (UPS)
- Switched-mode and resonant-mode power supplies
- AC motor speed control
- DC servo and robot drives
- DC choppers

Symbol	Test Conditions	Characteristic Values ($T_J = 25^\circ\text{C}$, unless otherwise specified)		
		min.	typ.	max.
$V_{GE(th)}$	$I_C = 250 \mu\text{A}$, $V_{CE} = V_{GE}$	2.5		5.0 V
I_{CES}	$V_{CE} = V_{CES}$ $V_{GE} = 0 \text{ V}$		$T_J = 25^\circ\text{C}$ $T_J = 150^\circ\text{C}$	50 μA 1 mA
I_{GES}	$V_{CE} = 0 \text{ V}$, $V_{GE} = \pm 20 \text{ V}$			$\pm 100 \text{ nA}$
$V_{CE(sat)}$	$I_C = 24 \text{ A}$, $V_{GE} = 15 \text{ V}$		$T_J = 25^\circ\text{C}$	1.8 V

Symbol	Test Conditions	Characteristic Values ($T_J = 25^\circ\text{C}$, unless otherwise specified)			
		min.	typ.	max.	
g_{fs}	$I_C = 24\text{ A}; V_{CE} = 10\text{ V}$, Pulse test, $t \leq 300\ \mu\text{s}$, duty cycle $\leq 2\%$	18	26	S	
C_{ies} C_{oes} C_{res}	$V_{CE} = 25\text{ V}, V_{GE} = 0\text{ V}, f = 1\text{ MHz}$		1500	pF	
			115	pF	
			40	pF	
Q_g Q_{ge} Q_{gc}	$I_C = 24\text{ A}, V_{GE} = 15\text{ V}, V_{CE} = 300\text{ V}$		66	nC	
			9	nC	
			22	nC	
$t_{d(on)}$ t_{ri} $t_{d(off)}$ t_{fi} E_{off}	Inductive load, $T_J = 25^\circ\text{C}$ $I_C = 24\text{ A}, V_{GE} = 15\text{ V}$ $V_{CE} = 400\text{ V}, R_G = 5\ \Omega$		13	ns	
			15	ns	
			110	200	ns
			82	150	ns
			0.32	0.6	mJ
$t_{d(on)}$ t_{ri} E_{on} $t_{d(off)}$ t_{fi} E_{off}	Inductive load, $T_J = 125^\circ\text{C}$ $I_C = 24\text{ A}, V_{GE} = 15\text{ V}$ $V_{CE} = 400\text{ V}, R_G = 5\ \Omega$		13	ns	
			17	ns	
			0.22		mJ
			200		ns
			150		ns
			0.9		mJ
R_{thJC} R_{thCK}	(TO-247)			0.65 KW KW	
		0.25			

Min. Recommended Footprint (Dimensions in inches and mm)

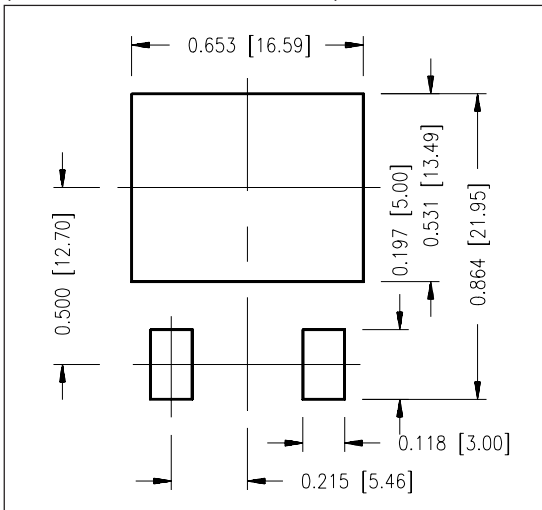

TO-247 AD Outline

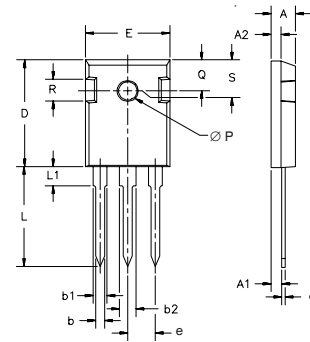

Dim.	Millimeter		Inches	
	Min.	Max.	Min.	Max.
A	4.7	5.3	.185	.209
A ₁	2.2	2.54	.087	.102
A ₂	2.2	2.6	.059	.098
b	1.0	1.4	.040	.055
b ₁	1.65	2.13	.065	.084
b ₂	2.87	3.12	.113	.123
C	.4	.8	.016	.031
D	20.80	21.46	.819	.845
E	15.75	16.26	.610	.640
e	5.20	5.72	0.205	0.225
L	19.81	20.32	.780	.800
L ₁		4.50		.177
∅P	3.55	3.65	.140	.144
Q	5.89	6.40	0.232	0.252
R	4.32	5.49	.170	.216
S	6.15	BSC	.242	BSC

TO-268 Outline

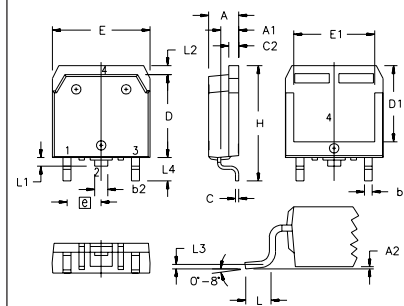

SYM	INCHES		MILLIMETERS	
	MIN	MAX	MIN	MAX
A	.193	.201	4.90	5.10
A ₁	.106	.114	2.70	2.90
A ₂	.001	.010	0.02	0.25
b	.045	.057	1.15	1.45
b ₂	.075	.083	1.90	2.10
C	.016	.026	0.40	0.65
C ₂	.057	.063	1.45	1.60
D	.543	.551	13.80	14.00
D ₁	.488	.500	12.40	12.70
E	.624	.632	15.85	16.05
E ₁	.524	.535	13.30	13.60
e	.215 BSC		5.45 BSC	
H	.736	.752	18.70	19.10
L	.094	.106	2.40	2.70
L ₁	.047	.055	1.20	1.40
L ₂	.039	.045	1.00	1.15
L ₃	.010 BSC		0.25 BSC	
L ₄	.150	.161	3.80	4.10

IXYS reserves the right to change limits, test conditions, and dimensions.

IXYS MOSFETs and IGBTs are covered by one or more of the following U.S. patents:

4,835,592 4,881,106 5,017,508 5,049,961 5,187,117 5,486,715 6,306,728B1 6,259,123B1 6,306,728B1
4,850,072 4,931,844 5,034,796 5,063,307 5,237,481 5,381,025 6,404,065B1 6,162,665 6,534,343 6,583,505

Fig. 1. Output Characteristics @ 25 Deg. C

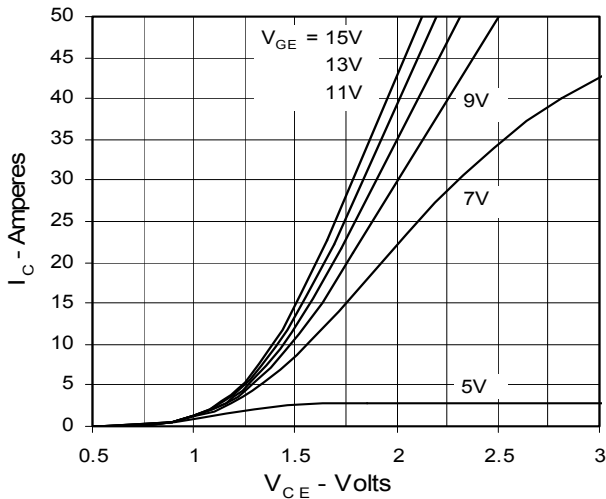

Fig. 2. Extended Output Characteristics @ 25 deg. C

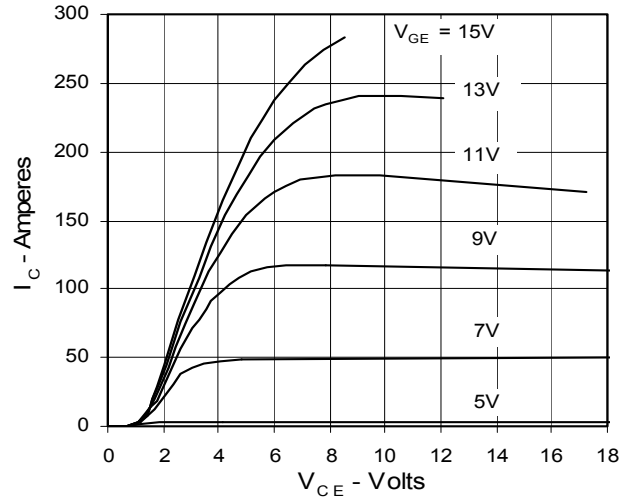

Fig. 3. Output Characteristics @ 125 Deg. C

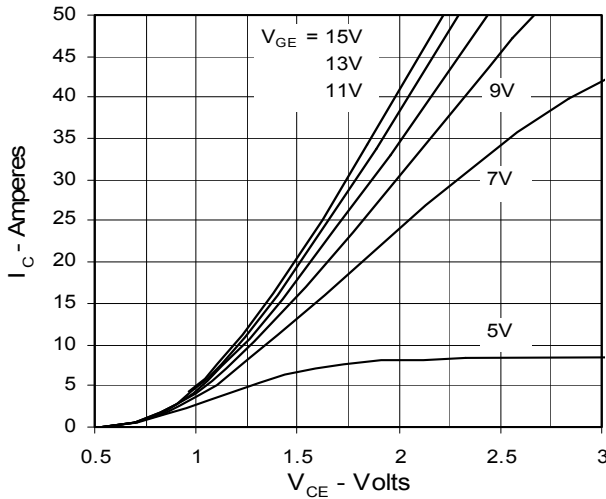

Fig. 4. Dependence of $V_{CE(sat)}$ on Temperature

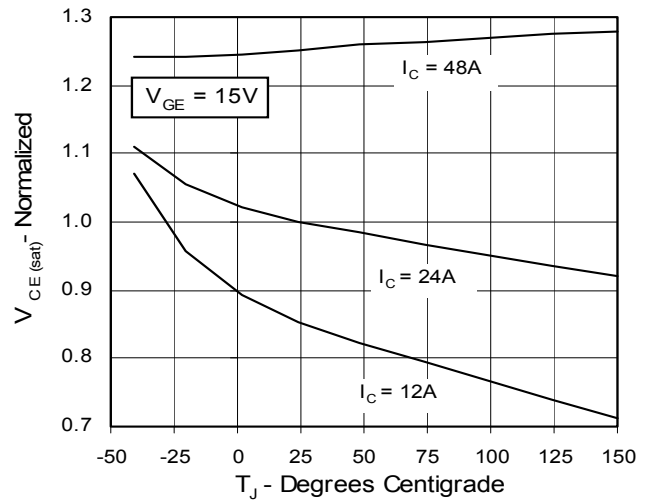

Fig. 5. Collector-to-Emitter Voltage vs. Gate-to-Emitter voltage

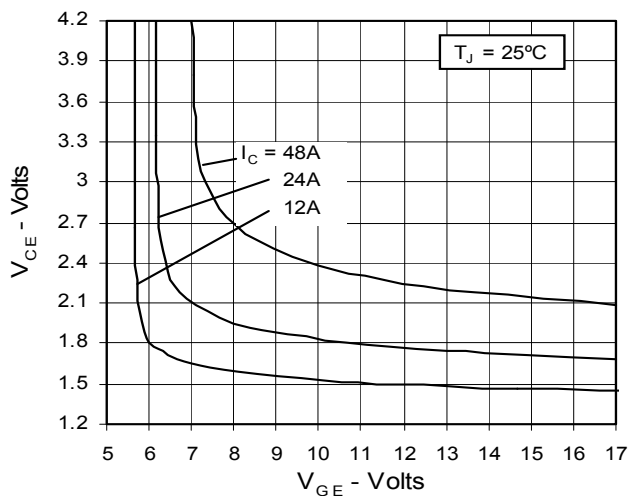

Fig. 6. Input Admittance

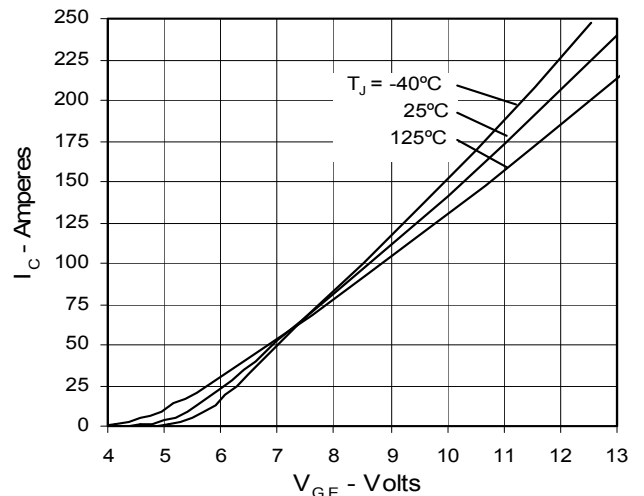

Fig. 7. Transconductance

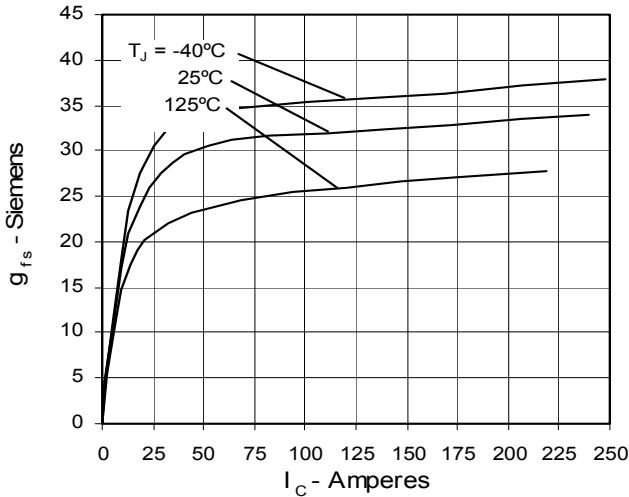

Fig. 8. Dependence of Turn-Off Energy on R_G

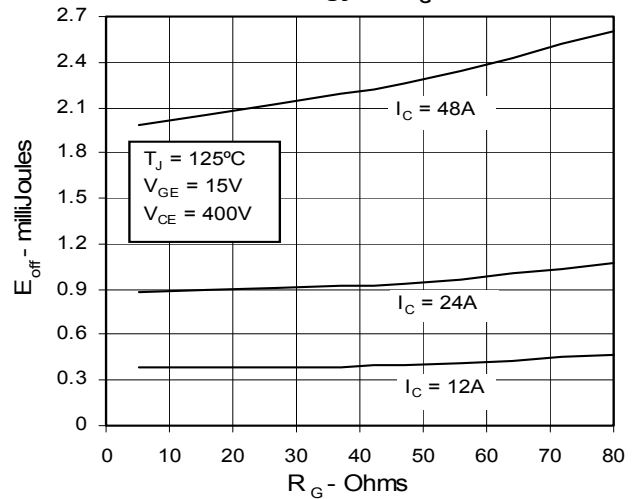

Fig. 9. Dependence of Turn-Off Energy on I_C

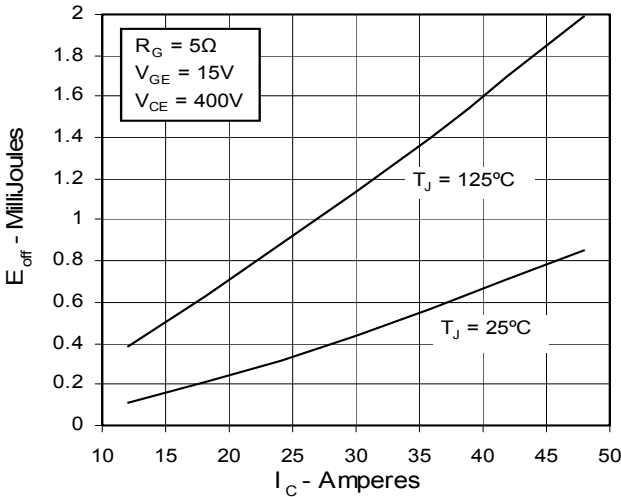

Fig. 10. Dependence of Turn-Off Energy on Temperature

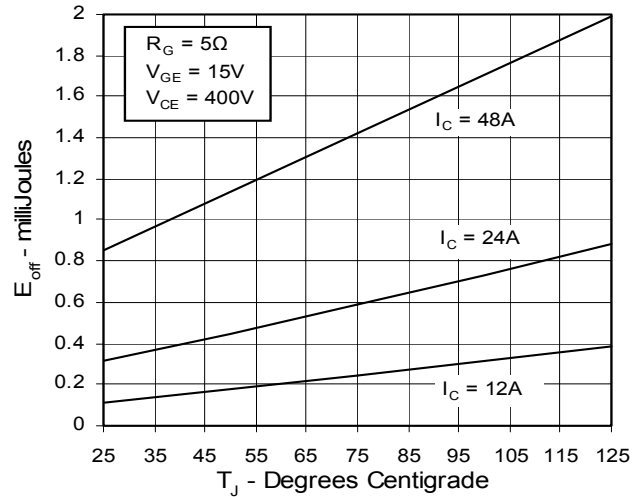

Fig. 11. Dependence of Turn-Off Switching Time on R_G

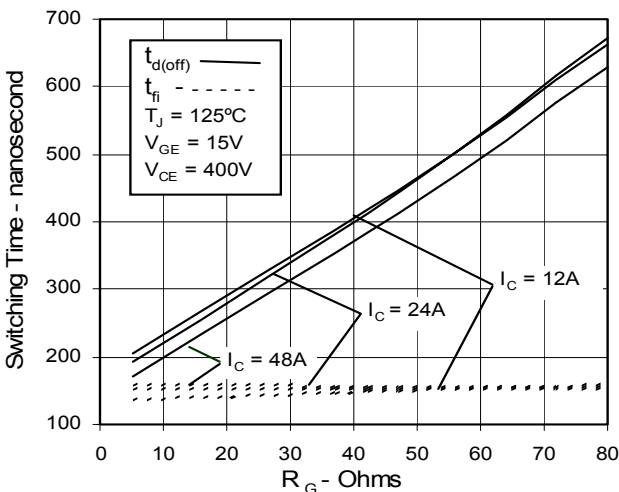
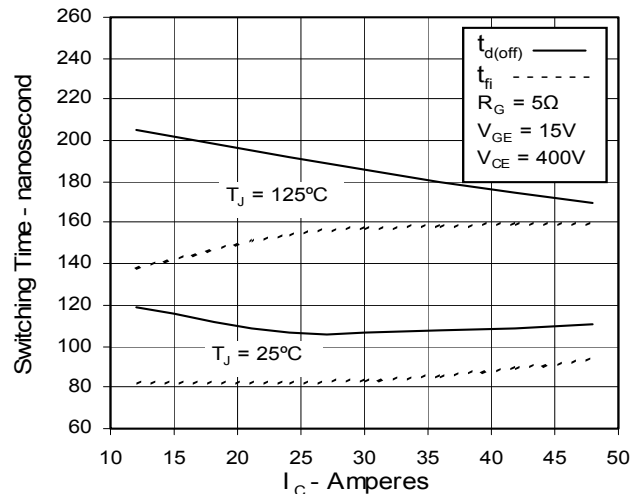

Fig. 12. Dependence of Turn-Off Switching Time on I_C



IXYS reserves the right to change limits, test conditions, and dimensions.

IXYS MOSFETs and IGBTs are covered by one or more of the following U.S. patents:

4,835,592 4,881,106 5,017,508 5,049,961 5,187,117 5,486,715 6,306,728B1 6,259,123B1 6,306,728B1
4,850,072 4,931,844 5,034,796 5,063,307 5,237,481 5,381,025 6,404,065B1 6,162,665 6,534,343 6,583,505

Fig. 13. Dependence of Turn-Off Switching Time on Temperature

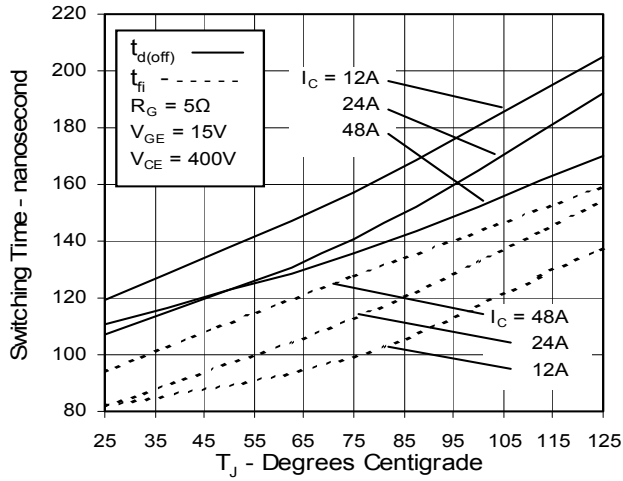

Fig. 14. Gate Charge

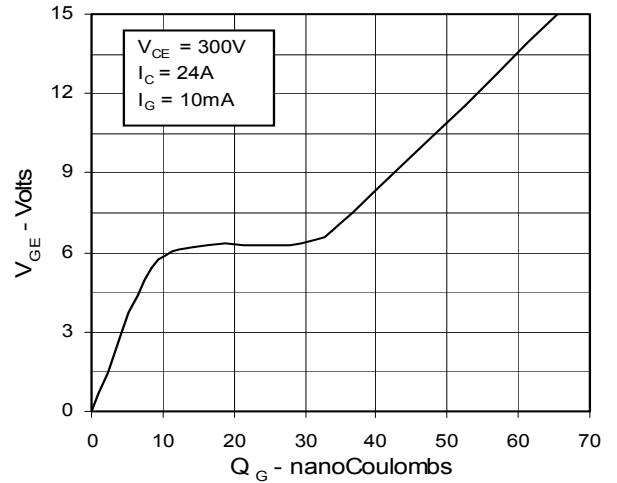

Fig. 15. Capacitance

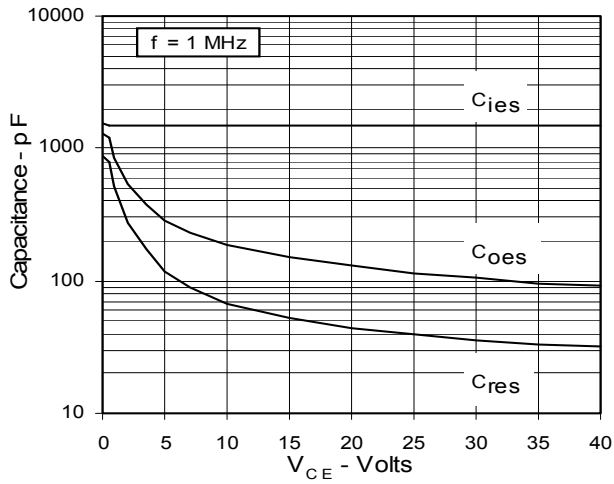
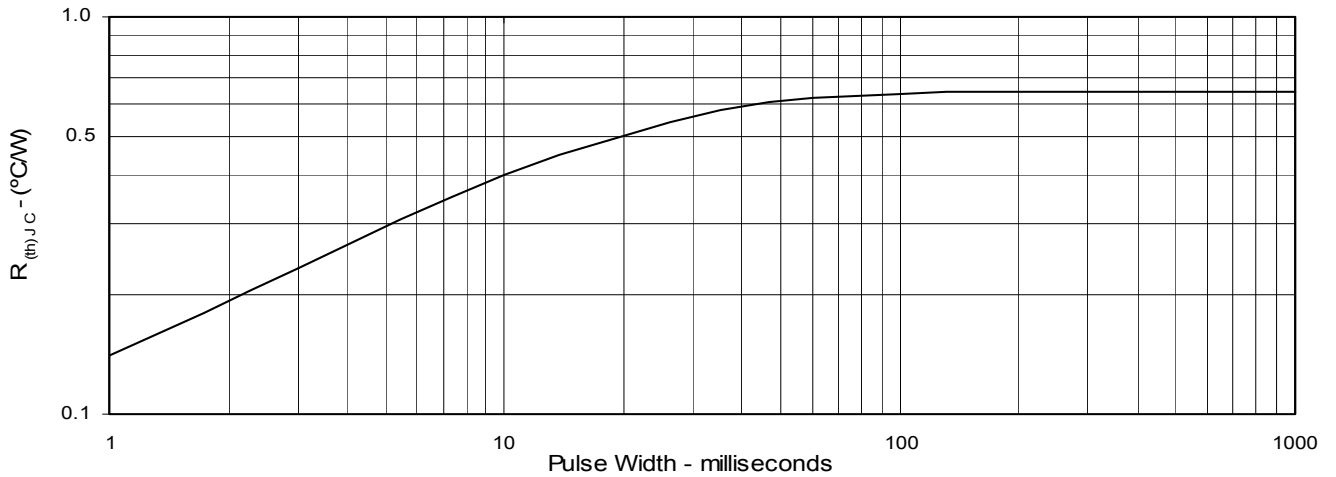

Fig. 16. Maximum Transient Thermal Resistance





Disclaimer Notice - Information furnished is believed to be accurate and reliable. However, users should independently evaluate the suitability of and test each product selected for their own applications. Littelfuse products are not designed for, and may not be used in, all applications. Read complete Disclaimer Notice at www.littelfuse.com/disclaimer-electronics.